

LHT65N LoRaWAN Temperature & Humidity Sensor Manual

Last modified by Xiaoling (/xwiki/bin/view/XWiki/Xiaoling) on 2023/05/16 11:51



Table of Contents:

- 1. Introduction
 - 1.1 What is LHT65N Temperature & Humidity Sensor
 - 1.2 Features
 - 1.3 Specification
- 2. Connect LHT65N to IoT Server
 - 2.1 How does LHT65N work?
 - 2.2 How to Activate LHT65N?
 - 2.3 Example to join LoRaWAN network
 - 2.3.1 Step 1: Create Device n TTN
 - 2.3.2 Step 2: Activate LHT65N by pressing the ACT button for more than 5 seconds.
 - 2.4 Uplink Payload (Fport=2)
 - 2.4.1 Decoder in TTN V3
 - 2.4.2 BAT-Battery Info
 - 2.4.3 Built-in Temperature
 - 2.4.4 Built-in Humidity
 - 2.4.5 Ext #
 - 2.4.6 Ext value
 - 2.4.6.1 Ext=1, E3 Temperature Sensor
 - 2.4.6.2 Ext=9, E3 sensor with Unix Timestamp
 - 2.4.6.3 Ext=6, ADC Sensor (use with E2 Cable)
 - 2.4.6.4 Ext=2 TMP117 Sensor (Since Firmware v1.3)
 - 2.4.6.5 Ext=11 SHT31 Sensor (Since Firmware v1.4.1)
 - 2.4.6.6 Ext=4 Interrupt Mode (Since Firmware v1.3)
 - 2.4.6.7 Ext=8 Counting Mode (Since Firmware v1.3)
 - 2.5 Show data on Datalog
 - 2.6 Datalog Feature
 - 2.6.1 Ways to get datalog via LoRaWAN
 - 2.6.2 Unix TimeStamp
 - 2.6.3 Set Device Time
 - 2.6.4 Poll sensor value
 - 2.6.5 Datalog Uplink payload
 - 2.7 Alarm Mode & Feature "Multi sampling, one uplink"
 - 2.7.1 ALARM MODE (Since v1.3.1 firmware)
 - 2.7.2 ALARM MODE (Before v1.3.1 firmware)
 - 2.8 LED Indicator

- 2.9 installation
- 3. Sensors and Accessories
 - 3.1 E2 Extension Cable
 - 3.2 E3 Temperature Probe
 - 3.3 E31F Temperature Probe
- 4. Configure LHT65N via AT command or LoRaWAN downlink
 - 4.1 Set Transmit Interval Time
 - 4.2 Set External Sensor Mode
 - 4.3 Enable/Disable uplink Temperature probe ID
 - 4.4 Set Password
 - 4.5 Quit AT Command
 - 4.6 Set to sleep mode
 - 4.7 Set system time
 - 4.8 Set Time Sync Mode
 - 4.9 Set Time Sync Interval
 - 4.10 Print data entries base on page.
 - 4.11 Print last few data entries.
 - 4.12 Clear Flash Record
 - 4.13 Auto Send None-ACK messages
 - 4.14 Modified WMOD command for external sensor TMP117 or DS18B20 temperature alarm (Since firmware 1.3.0)
- 5. Battery & How to replace
 - 5.1 Battery Type
 - 5.2 Replace Battery
 - 5.3 Battery Life Analyze
- 6. FAQ
 - 6.1 How to use AT Command?
 - 6.2 Where to use AT commands and Downlink commands
 - 6.3 How to change the uplink interval?
 - 6.4 How to use TTL-USB to connect a PC to input AT commands?
 - 6.5 How to use TTL-USB to connect PC to upgrade firmware?
 - 6.6 Using USB-TYPE-C to connect to the computer using the AT command
 - 6.7 How to use USB-TYPE-C to connect PC to upgrade firmware?
 - 6.8 Why can't I see the datalog information
- 7. Order Info
- 8. Packing Info
- 9. Reference material
- 10. FCC Warning

1. Introduction

1.1 What is LHT65N Temperature & Humidity Sensor

The Dragino LHT65N Temperature & Humidity sensor is a Long Range LoRaWAN Sensor. It includes a **built-in Temperature & Humidity sensor** and has an external sensor connector to connect to an external **Temperature Sensor**.

The LHT65N allows users to send data and reach extremely long ranges. It provides ultra-long range spread spectrum communication and high interference immunity whilst minimizing current consumption. It targets professional wireless sensor network applications such as irrigation systems, smart metering, smart cities, building automation, and so on.

LHT65N has a built-in 2400mAh non-chargeable battery which can be used for up to 10 years*.

LHT65N is full compatible with LoRaWAN v1.0.3 Class A protocol, it can work with a standard LoRaWAN gateway.

LHT65N supports **Datalog Feature**. It will record the data when there is no network coverage and users can retrieve the sensor value later to ensure no miss for every sensor reading.

*The actual battery life depends on how often to send data, please see the battery analyzer chapter.

1.2 Features

- LoRaWAN v1.0.3 Class A protocol
- Frequency Bands: CN470/EU433/KR920/US915/EU868/AS923/AU915
- AT Commands to change parameters
- Remote configure parameters via LoRaWAN Downlink
- Firmware upgradeable via program port
- Built-in 2400mAh battery for up to 10 years of use.
- Built-in Temperature & Humidity sensor
- Optional External Sensors
- Tri-color LED to indicate working status
- Datalog feature (Max 3328 records)

1.3 Specification

Built-in Temperature Sensor:

- Resolution: 0.01 °C
- Accuracy Tolerance : Typ ±0.3 °C
- Long Term Drift: < 0.02 °C/yr
- Operating Range: -40 ~ 85 °C

Built-in Humidity Sensor:

- Resolution: 0.04 %RH
- Accuracy Tolerance : Typ ±3 %RH
- Long Term Drift: < 0.02 °C/yr
- Operating Range: 0 ~ 96 %RH

External Temperature Sensor:

- Resolution: 0.0625 °C
- ±0.5°C accuracy from -10°C to +85°C
- ±2°C accuracy from -55°C to +125°C
- Operating Range: -55 °C ~ 125 °C

2. Connect LHT65N to IoT Server

2.1 How does LHT65N work?

LHT65N is configured as LoRaWAN OTAA Class A mode by default. Each LHT65N is shipped with a worldwide unique set of OTAA keys. To use LHT65N in a LoRaWAN network, first, we need to put the OTAA keys in LoRaWAN Network Server and then activate LHT65N.

If LHT65N is under the coverage of this LoRaWAN network. LHT65N can join the LoRaWAN network automatically. After successfully joining, LHT65N will start to measure environment temperature and humidity, and start to transmit sensor data to the LoRaWAN server. The default period for each uplink is 20 minutes.

2.2 How to Activate LHT65N?

The LHT65N has two working modes:

- **Deep Sleep Mode:** LHT65N doesn't have any LoRaWAN activation. This mode is used for storage and shipping to save battery life.
- **Working Mode:** In this mode, LHT65N works as LoRaWAN Sensor mode to Join LoRaWAN network and send out the sensor data to the server. Between each sampling/tx/rx periodically, LHT65N will be in STOP mode (IDLE mode), in STOP mode, LHT65N has the same power consumption as Deep Sleep mode.

The LHT65N is set in deep sleep mode by default; The ACT button on the front is to switch to different modes:



Behavior on ACT	Function	Action
Pressing ACT between 1s < time < 3s	Test uplink status	If LHT65N is already Joined to the LoRaWAN network, LHT65N will send an uplink packet, if LHT65N has external sensor connected, Blue led will blink once. If LHT65N has not external sensor, Red led will blink once.

Pressing ACT for more than 3s	Active Device	Green led will fast blink 5 times, LHT65N will enter working mode and start to JOIN LoRaWAN network. Green led will solidly turn on for 5 seconds after join in network.
Fast press ACT 5 times.	Deactivate Device	Red led will solid on for 5 seconds. Means LHT65N is in Deep Sleep Mode.

2.3 Example to join LoRaWAN network

This section shows an example of how to join the TTN V3 LoRaWAN IoT server. Use with other LoRaWAN IoT servers is of a similar procedure.

LHT65N in a LoRaWAN Network



Assume the LPS8N is already set to connect to TTN V3 network (<https://eu1.cloud.thethings.network>), So it provides network coverage for LHT65N. Next we need to add the LHT65N device in TTN V3:

2.3.1 Step 1: Create Device in TTN

Create a device in TTN V3 with the OTAA keys from LHT65N.

Each LHT65N is shipped with a sticker with its device EUI, APP Key and APP EUI as below:



User can enter these keys in the LoRaWAN Server portal. Below is TTN V3 screenshot:

Add APP EUI in the application.

Add application

Owner*
davidhuang

Application ID*
my-new-application

Application name
My new application

Description
Description for my new application

Optional application description; can also be used to save notes about the application

Create application

ccc 123

4 End devices 2 Collaborators 2 API keys Created 10 days ago

General information
Application ID: 123
Created at: Feb 2, 2021 13:22:30
Last updated at: Apr 30, 2021 11:00:33

Live data
10:00:42 1231234234. Forward data message to Application Server
10:00:42 1231234234. Store uplink data message
10:00:42 1231234234. Process uplink data message
10:00:42 1231234234. Receive uplink data message
10:00:42 1231234234. Successfully processed data message
10:00:42 1231234234. Drop data message

End devices (4)

Search by ID Import end device Add end device

Register end device

From The LoRaWAN Device Repository Manually

1. Select the end device

Brand*
Dragino Technology Co.,...

Model*
[type to search...]

Cannot find your exact end device?

2. Enter registration data

Please choose an end device first to

Register end device

LBT1
LDD520
LDD575
LDS01
LGT92
LHT65
LSE01
LSN50-V2

Note: LHT65N use same payload as LHT65.



2. Enter registration data

Frequency plan *

Select...

The frequency plan used by the end device

AppEUI *

.. .. . 00

The AppEUI uniquely identifies the owner of the end device. If no AppEUI is provided by the device manufacturer (usually for development), it can be filled with zeros.

DevEUI *

.. .. .

The DevEUI is the unique identifier for this end device

AppKey *

.. .. .

Input APP EUI, APP KEY and DEV EUI:

2. Enter registration data

Frequency plan *

Europe 863-870 MHz (SF12 for RX2)

The frequency plan used by the end device

AppEUI *

.. .. . 00

The AppEUI uniquely identifies the owner of the end device. If no AppEUI is provided by the device manufacturer (usually for dev

DevEUI *

.. .. .

The DevEUI is the unique identifier for this end device

AppKey *

.. .. .

The root key to derive session keys to secure communication between the end device and the application

End device ID *

my-new-device

After registration

2.3.2 Step 2: Activate LHT65N by pressing the ACT button for more than 5 seconds.

Use ACT button to activate LHT65N and it will auto-join to the TTN V3 network. After join success, it will start to upload sensor data to TTN V3 and user can see in the panel.

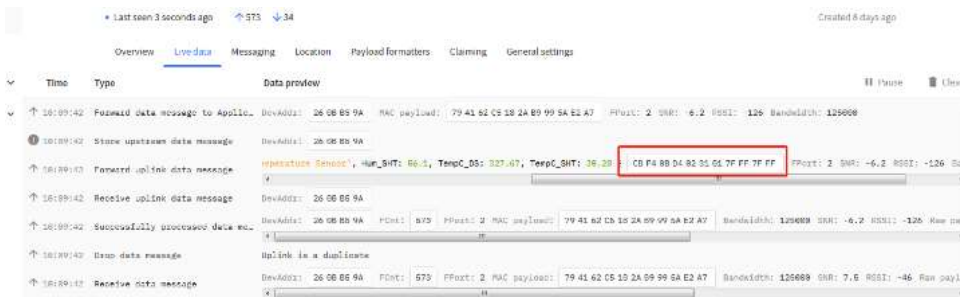

2.4 Uplink Payload (Fport=2)

The uplink payload includes totally 11 bytes. Uplink packets use FPORT=2 and **every 20 minutes** send one uplink by default.

After each uplink, the **BLUE LED** will blink once.

Size(bytes)	2	2	2	1	4
Value	BAT	Built-In Temperature	Built-in Humidity	Ext #	Ext value

- The First 6 bytes: has fix meanings for every LHT65N.
- The 7th byte (EXT #): defines the external sensor model.
- The 8th ~ 11th byte: the value for external sensor value. The definition is based on external sensor type. (If EXT=0, there won't be these four bytes.)

2.4.1 Decoder in TTN V3

When the uplink payload arrives TTNv3, it shows HEX format and not friendly to read. We can add LHT65N decoder in TTNv3 for friendly reading.

Below is the position to put the decoder and LHT65N decoder can be download from here: <https://github.com/dragino/dragino-end-node-decoder> (<https://github.com/dragino/dragino-end-node-decoder>)

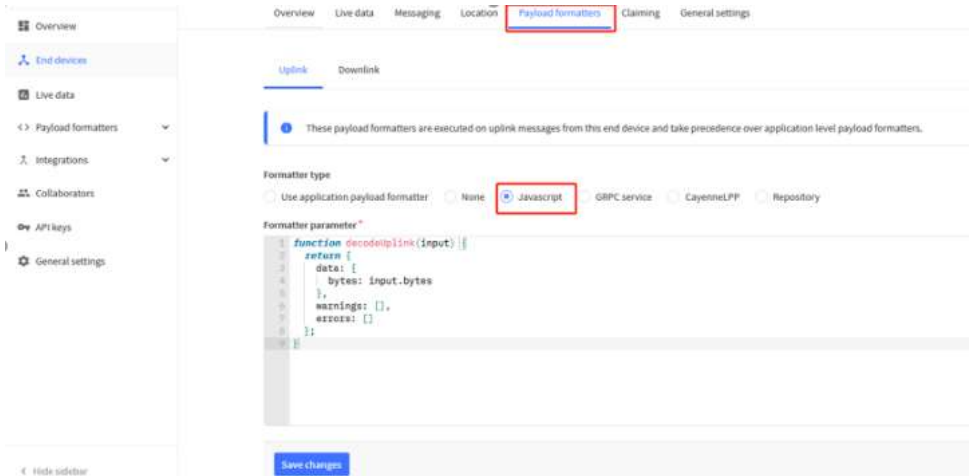

2.4.2 BAT-Battery Info

These two bytes of BAT include the battery state and the actually voltage.

Bit(bit)	[15:14]	[13:0]
Value	BAT Status 00(b): Ultra Low (BAT <= 2.50v) 01(b): Low (2.50v <=BAT <= 2.55v) 10(b): OK (2.55v <= BAT <=2.65v) 11(b): Good (BAT >= 2.65v)	Actually BAT voltage

(b)stands for binary



Check the battery voltage for LHT65N.

- BAT status=(0xcba4>>14)&0xFF=11 (BIN) , very good
- Battery Voltage =0xCBA4&0x3FFF=0x0BA4=2980mV

2.4.3 Built-in Temperature



- Temperature: 0x0ABB/100=27.47°C

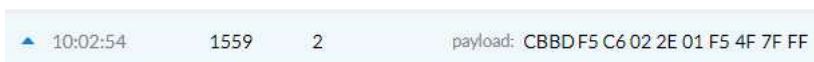

- Temperature: (0xF5C6-65536)/100=-26.18°C

2.4.4 Built-in Humidity

```
AC payload: 5F 6B FD 0B 99 51 A3 A8 84 40 37 FPort: 2 SNR: 10.8 RSSI: -41 Bandwidth: 1
SHT: 60.4, TempC_DS: 327.67, TempC_SHT: 27.47 } CB A4 0A BB 02 5C 01 7F FF 7F FF FPort:
```

- Humidity: $0x025C/10=60.4\%$

2.4.5 Ext

Bytes for External Sensor:

EXT # Value	External Sensor Type
0x01	Sensor E3, Temperature Sensor
0x09	Sensor E3, Temperature Sensor, Datalog Mod

2.4.6 Ext value

2.4.6.1 Ext=1, E3 Temperature Sensor

APPLICATION DATA

Filters: uplink downlink activation ack error

time	counter	port	payload
08:38:57	375	2	CB F6 0B 0D 03 76 01 0A DD 7F FF

- DS18B20 temp= $0x0ADD/100=27.81^{\circ}\text{C}$

The last 2 bytes of data are meaningless

10:02:54	1559	2	payload: CB BD F5 C6 02 2E 01 F5 4F 7F FF
----------	------	---	---

- External temperature= $(0xF54F-65536)/100=-27.37^{\circ}\text{C}$

F54F : $(F54F \& 8000 == 1)$, temp = $(F54F - 65536)/100 = 27.37^{\circ}\text{C}$

(0105 & 8000: Judge whether the highest bit is 1, when the highest bit is 1, it is negative)

The last 2 bytes of data are meaningless

If the external sensor is 0x01, and there is no external temperature connected. The temperature will be set to 7FFF which is 327.67°C

2.4.6.2 Ext=9, E3 sensor with Unix Timestamp

Timestamp mode is designed for LHT65N with E3 probe, it will send the uplink payload with Unix timestamp. With the limitation of 11 bytes (max distance of AU915/US915/AS923 band), the time stamp mode will be lack of BAT voltage field, instead, it shows the battery status. The payload is as below:

Size(bytes)	2	2	2	1	4
Value	External temperature	Built-In Temperature	BAT Status & Built-in Humidity	Status & Ext	Unix Time Stamp

- **Battery status & Built-in Humidity**

Bit(bit)	[15:14]	[11:0]
----------	---------	--------

Value	BAT Status 00(b): Ultra Low (BAT <= 2.50v) 01(b): Low (2.50v <=BAT <= 2.55v) 10(b): OK (2.55v <= BAT <=2.65v) 11(b): Good (BAT >= 2.65v)	Built-in Humidity
--------------	---	-------------------

• **Status & Ext Byte**

Bits	7	6	5	4	[3:0]
Status&Ext	None-ACK Flag	Poll Message FLAG	Sync time OK	Unix Time Request	Ext: 0b(1001)

- **Poll Message Flag:** 1: This message is a poll message reply, 0: means this is a normal uplink.
- **Sync time OK:** 1: Set time ok, 0: N/A. After time SYNC request is sent, LHT65N will set this bit to 0 until got the time stamp from the application server.
- **Unix Time Request:** 1: Request server downlink Unix time, 0 : N/A. In this mode, LHT65N will set this bit to 1 every 10 days to request a time SYNC. (AT+SYNCMOD to set this)

2.4.6.3 Ext=6, ADC Sensor (use with E2 Cable)

In this mode, user can connect external ADC sensor to check ADC value. The 3V3_OUT can be used to power the external ADC sensor; user can control the power on time for this

sensor by setting:

AT+EXT=6,timeout **Time to power this sensor, from 0 ~ 65535ms**

For example:

AT+EXT=6,1000 will power this sensor for 1000ms before sampling the ADC value.

Or use **downlink command A2** to set the same.

The measuring range of the node is only about 0.1V to 1.1V The voltage resolution is about 0.24mv.

When the measured output voltage of the sensor is not within the range of 0.1V and 1.1V, the output voltage terminal of the sensor shall be divided The example in the following figure is to reduce the output voltage of the sensor by three times If it is necessary to reduce more times, calculate according to the formula in the figure and connect the corresponding resistance in series.

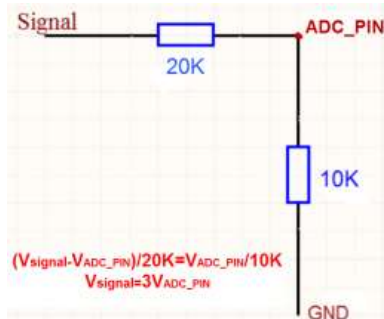

When ADC_IN1 pin is connected to GND or suspended, ADC value is 0

```
Payload: { ADC_V: 0, BatV: 3.106, Bat_status: 3, Hum_SHT: 45.2, TempC_SHT: 28.11, Work_mode: "ADC Sensor" }
```

When the voltage collected by ADC_IN1 is less than the minimum range, the minimum range will be used as the output; Similarly, when the collected voltage is greater than the maximum range, the maximum range will be used as the output.

1) The minimum range is about 0.1V. Each chip has internal calibration, so this value is close to 0.1V

```
Payload: { ADC_V: 0.084, BatV: 3.106, Bat_status: 3, Hum_SHT: 44.9, TempC_SHT: 28.13, Work_mode: "ADC Sensor" }
```

2) The maximum range is about 1.1V. Each chip has internal calibration, so this value is close to 1.1v

```
Payload: { ADC_V: 1.085, BatV: 3.108, Bat_status: 3, Hum_SHT: 46.5, TempC_SHT: 28.16, Work_mode: "ADC Sensor" }
```

3) Within range

```
Payload: { ADC_V: 0.427, BatV: 3.099, Bat_status: 3, Hum_SHT: 45.1, TempC_SHT: 27.47, Work_mode: "ADC Sensor" }
```

2.4.6.4 Ext=2 TMP117 Sensor (Since Firmware v1.3)



Ext=2, Temperature Sensor(TMP117):

```
Payload: { BatV: 3.054, Bat_status: 3, Ext_sensor: "Temperature Sensor", Hum_SHT: 59.9, TempC_SHT: 29.16, TempC_TMP117: 27.55 }
```

Interrupt Mode and Counting Mode:

The external cable NE2 can be use for MOD4 and MOD8

2.4.6.5 Ext=11 SHT31 Sensor (Since Firmware v1.4.1)



Ext=11, Temperature & Humidity Sensor(SHT31):

```
Payload: { BatV: 3.072, Bat_status: 3, Ext_Hum_SHT: 61.9, Ext_TempC_SHT: 27.58, Hum_SHT: 61.9, TempC_SHT: 28.26, Work_mode: "SHT31 Sensor" } CC 00 0B 0A 02 6B 0B 0A ... <> |
```

2.4.6.6 Ext=4 Interrupt Mode (Since Firmware v1.3)

Note: In this mode, 3.3v output will be always ON. LHT65N will send an uplink when there is a trigger.

Interrupt Mode can be used to connect to external interrupt sensors such as:

Case 1: Door Sensor. 3.3v Out for such sensor is just to detect Open/Close.

In Open State, the power consumption is the same as if there is no probe

In Close state, the power consumption will be 3uA higher than normal.

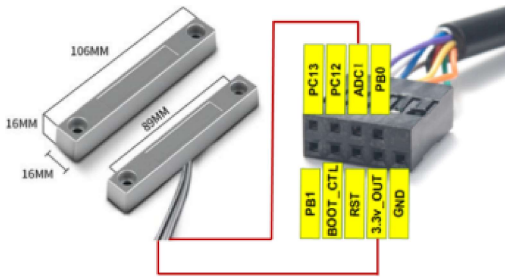

Ext=4, Interrupt Sensor:

AT+EXT=4,1	Sent uplink packet in both rising and falling interrupt
AT+EXT=4,2	Sent uplink packet only in falling interrupt
AT+EXT=4,3	Sent uplink packet only in rising interrupt

Trigger by falling edge:

```
Payload: { BatV: 3.078, Bat_status: 3, Exti_pin_level: "Low", Exti_status: "True", Hum_SHT: 48.4, TempC_SHT: 28.3, Work_mode: "Interrupt Sensor send" }
```

Trigger by raising edge:

```
Payload: { BatV: 3.079, Bat_status: 3, Exti_pin_level: "High", Exti_status: "True", Hum_SHT: 48.6, TempC_SHT: 28.3, Work_mode: "Interrupt Sensor send" }
```

2.4.6.7 Ext=8 Counting Mode (Since Firmware v1.3)

Note: In this mode, 3.3v output will be always ON. LHT65N will count for every interrupt and uplink periodically.

Case 1: Low power consumption Flow Sensor, such flow sensor has pulse output and the power consumption in uA level and can be powered by LHT65N.

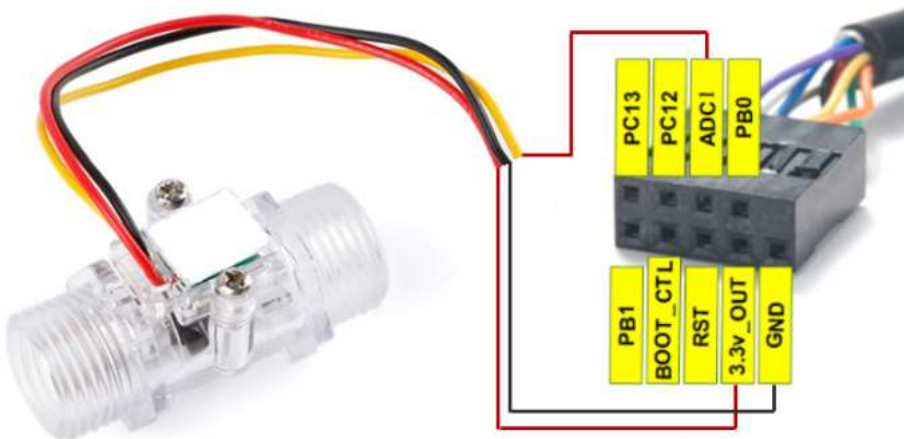

Case 2: Normal Flow Sensor: Such flow sensor has higher power consumption and is not suitable to be powered by LHT65N. It is powered by external power and output <3.3v pulse

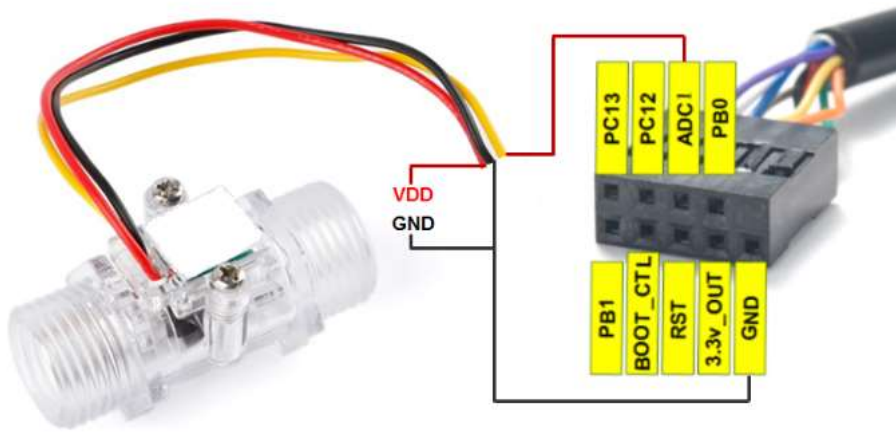

Ext=8, Counting Sensor (4 bytes):

AT+EXT=8,0	Count at falling interrupt
AT+EXT=8,1	Count at rising interrupt
AT+SETCNT=60	Sent current count to 60

```
Payload: { BatV: 3.072, Bat_status: 3, Exit_count: 25, Hum_SHT: 48.6, TempC_SHT: 28.41, Work_mode: "Interrupt Sensor count" }
```

A2 downlink Command:

A2 02: Same as AT+EXT=2 (AT+EXT= second byte)

A2 06 01 F4: Same as AT+EXT=6,500 (AT+EXT= second byte, third and fourth bytes)

A2 04 02: Same as AT+EXT=4,2 (AT+EXT= second byte, third byte)

A2 08 01 00: Same as AT+EXT=8,0 (AT+EXT= second byte, fourth byte)

A2 08 02 00 00 3C: Same as AT+ SETCNT=60 (AT+ SETCNT = 4th byte and 5th byte and 6th byte and 7th byte)

2.5 Show data on Datacake

Datacake IoT platform provides a human-friendly interface to show the sensor data, once we have sensor data in TTN V3, we can use Datacake to connect to TTN V3 and see the data in Datacake. Below are the steps:

Step 1: Be sure that your device is programmed and properly connected to the LoRaWAN network.

Step 2: Configure your Application to forward data to Datacake you will need to add integration. Go to TTN V3 Console --> Applications --> Integrations --> Add Integrations.

Add Datacake:

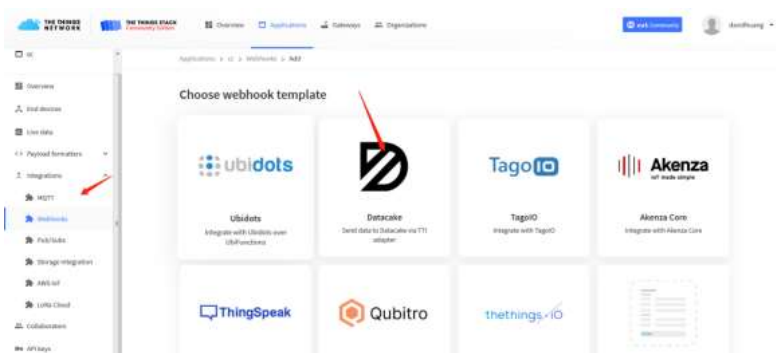

Select default key as Access Key:

Add custom webhook

Template information



Datacake

Send data to Datacake via TTI adapter

[About Datacake](#) | [Documentation](#)

Template settings

Webhook ID *

Token *

Datacake API Token

Create datacake webhook

In Datacake console (<https://datacake.co/> (<https://datacake.co/>)), add LHT65 device.

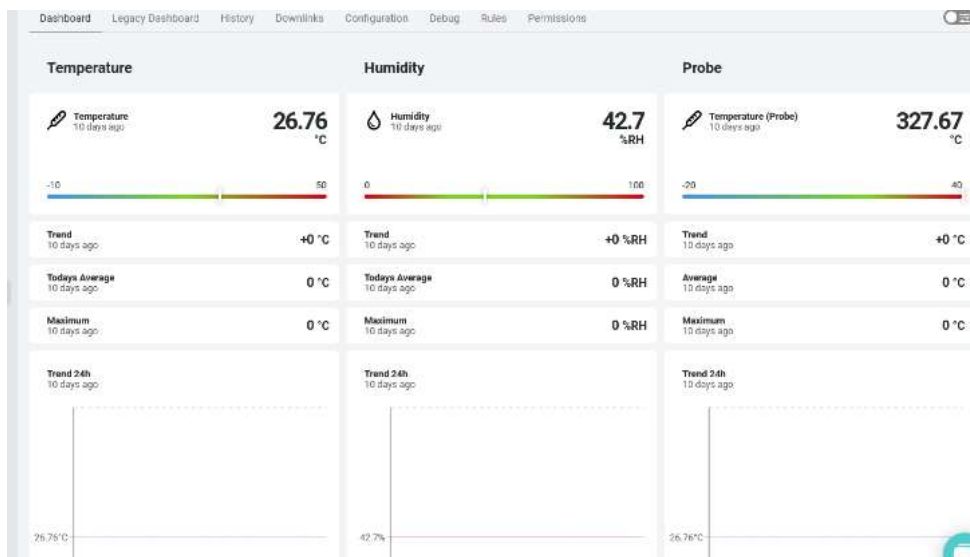
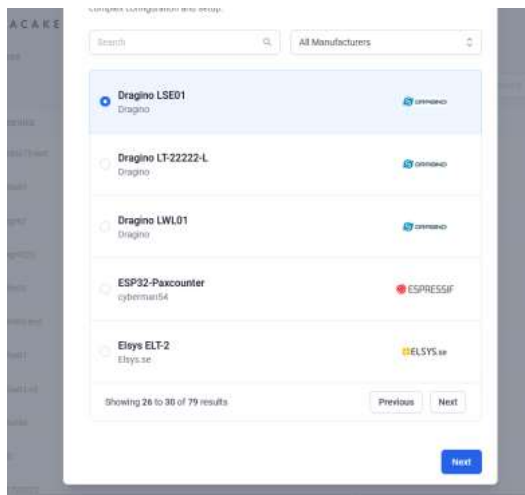

2.6 Datalog Feature

Datalog Feature is to ensure IoT Server can get all sampling data from Sensor even if the LoRaWAN network is down. For each sampling, LHT65N will store the reading for future retrieving purposes. There are two ways for IoT servers to get datalog from LHT65N.

2.6.1 Ways to get datalog via LoRaWAN

There are two methods:

Method 1: IoT Server sends a downlink LoRaWAN command to poll the value for specified time range.

Method 2: Set PNACKMD=1, LHT65N will wait for ACK for every uplink, when there is no LoRaWAN network, LHT65N will mark these records with non-ack messages and store the sensor data, and it will send all messages (10s interval) after the network recovery.

Note for method 2:

- a) LHT65N will do an ACK check for data records sending to make sure every data arrive server.
- b) LHT65N will send data in **CONFIRMED Mode** when PNACKMD=1, but LHT65N won't re-transmit the packet if it doesn't get ACK, it will just mark it as a NONE-ACK message. In a future uplink if LHT65N gets a ACK, LHT65N will consider there is a network connection and resend all NONE-ACK Message.

Below is the typical case for the auto-update datalog feature (Set PNACKMD=1)

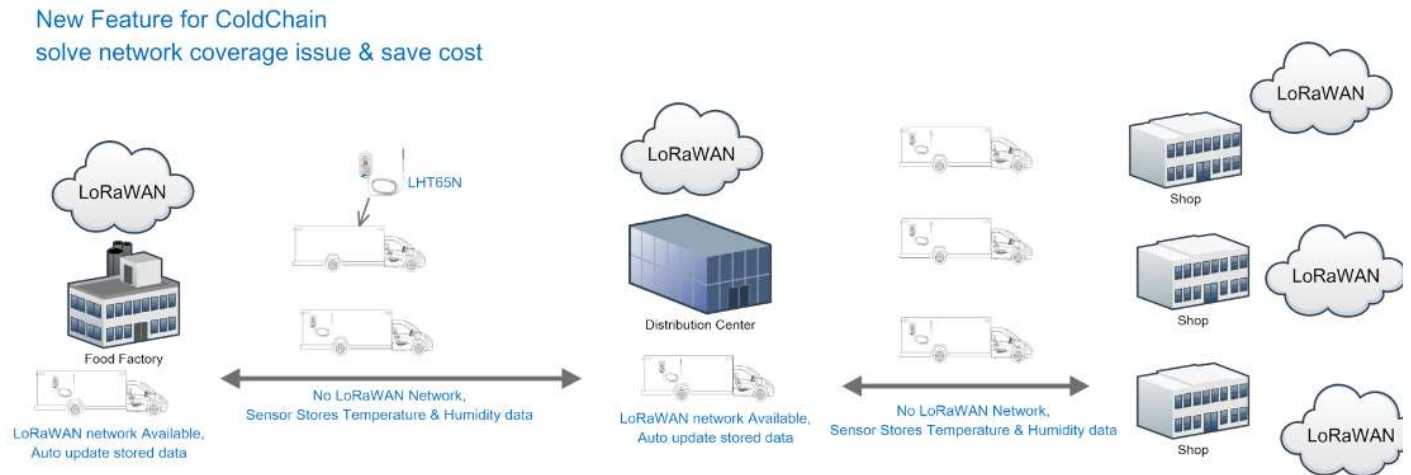

2.6.2 Unix TimeStamp

LHT65N uses Unix TimeStamp format based on

Size (bytes)	4	1
DeviceTimeAns Payload	32-bit unsigned integer : Seconds since epoch*	8bits unsigned integer: fractional-second in 1/2^8 second steps

Figure 10 : DeviceTimeAns payload format

User can get this time from link: <https://www.epochconverter.com/> (<https://www.epochconverter.com/>) :

Below is the converter example

So, we can use AT+TIMESTAMP=1611889405 or downlink 3060137afd00 to set the current time 2021 – Jan -- 29 Friday 03:03:25

2.6.3 Set Device Time

There are two ways to set device's time:

1. Through LoRaWAN MAC Command (Default settings)

User need to set SYNCMOD=1 to enable sync time via MAC command.

Once LHT65N Joined LoRaWAN network, it will send the MAC command (DeviceTimeReq) and the server will reply with (DeviceTimeAns) to send the current time to LHT65N. If LHT65N fails to get the time from the server, LHT65N will use the internal time and wait for next time request (AT+SYNCTDC to set the time request period, default is 10 days).

Note: LoRaWAN Server need to support LoRaWAN v1.0.3(MAC v1.0.3) or higher to support this MAC command feature, Chirpstack,TTN V3 v3 and loriot support but TTN V3 v2 doesn't support. If server doesn't support this command, it will through away uplink packet with this command, so user will lose the packet with time request for TTN V3 v2 if SYNCMOD=1.

2. Manually Set Time

User needs to set SYNCMOD=0 to manual time, otherwise, the user set time will be overwritten by the time set by the server.

2.6.4 Poll sensor value

User can poll sensor value based on timestamps from the server. Below is the downlink command.

1byte	4bytes	4bytes	1byte
31	Timestamp start	Timestamp end	Uplink Interval

Timestamp start and Timestamp end use Unix TimeStamp format as mentioned above. Devices will reply with all data log during this time period, use the uplink interval.

For example, downlink command **31 5FC5F350 5FC6 0160 05**

Is to check 2020/12/1 07:40:00 to 2020/12/1 08:40:00's data

Uplink Internal =5s, means LHT65N will send one packet every 5s. range 5~255s.

2.6.5 Datalog Uplink payload

The Datalog poll reply uplink will use below payload format.

Retrieval data payload:

Size(bytes)	2	2	2	1	4
Value	External sensor data	Built In Temperature	Built-in Humidity	Poll message flag & Ext	Unix Time Stamp

Poll message flag & Ext:

Bits	7	6	5	4	[3:0]
Status & Ext	No ACK Message	Poll Message Flag	Sync time OK	Unix Time Request	Ext: 0b(1001)

No ACK Message: 1: This message means this payload is fromn Uplink Message which doesn't get ACK from the server before (for PNACKMD=1 feature)

Poll Message Flag: 1: This message is a poll message reply.

- Poll Message Flag is set to 1.
- Each data entry is 11 bytes, to save airtime and battery, devices will send max bytes according to the current DR and Frequency bands.

For example, in US915 band, the max payload for different DR is:

a) **DR0:** max is 11 bytes so one entry of data

b) **DR1:** max is 53 bytes so devices will upload 4 entries of data (total 44 bytes)

c) **DR2:** total payload includes 11 entries of data

d) **DR3:** total payload includes 22 entries of data.

If devise doesn't have any data in the polling time. Device will uplink 11 bytes of 0

Example:

If LHT65N has below data inside Flash:

Flash Add	Unix Time	Ext	BAT voltage	Value
80196E0	21/1/19 04:27:03	1	3145	sht_temp=22.00 sht_hum=32.6 ds_temp=327.67
80196F0	21/1/19 04:28:57	1	3145	sht_temp=21.90 sht_hum=33.1 ds_temp=327.67
8019600	21/1/19 04:30:30	1	3145	sht_temp=21.81 sht_hum=33.4 ds_temp=327.67
8019610	21/1/19 04:40:30	1	3145	sht_temp=21.65 sht_hum=33.7 ds_temp=327.67
8019620	21/1/19 04:50:30	1	3147	sht_temp=21.55 sht_hum=34.1 ds_temp=327.67
8019630	21/1/19 04:00:30	1	3149	sht_temp=21.50 sht_hum=34.1 ds_temp=327.67
8019640	21/1/19 04:10:30	1	3149	sht_temp=21.43 sht_hum=34.6 ds_temp=327.67
8019650	21/1/19 04:20:30	1	3151	sht_temp=21.35 sht_hum=34.9 ds_temp=327.67

If user sends below downlink command: 3160065F9760066DA705

Where : Start time: 60065F97 = time 21/1/19 04:27:03

Stop time: 60066DA7= time 21/1/19 05:27:03

LHT65N will uplink this payload.

09:57:27 102 2 payload: 7F FF 08 98 01 46 41 60 06 5F 97 7F FF 08 8E 01 4B 41 60 06 60 09 7F FF

Uplink

Payload

7F FF 08 98 01 46 41 60 06 5F 97 7F FF 08 8E 01 4B 41 60 06 60 09 7F FF 08 85 01 4E 41 60 06 60 66 7F FF 08 75 01 51 41 60 06

Fields

no fields

Metadata

```
{
  "time": "2021-01-20T01:57:27.690185935Z",
  "frequency": 904.5,
  "modulation": "LORA",
  "data_rate": "5F7BW125",
  "coding_rate": "4/5",
  "gateways": [
    {
      "gtw_id": "eui-a840411cfe60415c",
      "timestamp": 3278993355,
      "time": "2021-01-20T01:57:27.544057Z",
      "channel": 3,
      "rssi": -55,
      "snr": 10
    }
  ]
}
```

7FFF089801464160065F97 7FFF 088E 014B 41 60066009

7FFF0885014E41600660667FFF0875015141600662BE7FFF086B015541600665167FFF08660155416006676E7FFF085F015A41600669C67FFF0857015D4160066C

Where the first 11 bytes is for the first entry:

7FFF089801464160065F97

Ext sensor data=0x7FFF/100=327.67

Temp=0x088E/100=22.00

Hum=0x014B/10=32.6

poll message flag & Ext=0x41, means reply data, Ext=1

Unix time is 0x60066009=1611030423s=21/1/19 04:27:03

2.7 Alarm Mode & Feature "Multi sampling, one uplink"

when the device is in alarm mode, it checks the built-in sensor temperature for a short time. if the temperature exceeds the preconfigured range, it sends an uplink immediately.

Note: alarm mode adds a little power consumption, and we recommend extending the normal read time when this feature is enabled.

2.7.1 ALARM MODE (Since v1.3.1 firmware)

Internal GXHT30 temperature alarm (Acquisition time: fixed at one minute)

AT+WMOD=3: Enable/disable alarm mode. (0: Disabled, 1: Enabled Temperature Alarm for onboard temperature sensor)

AT+CITEMP=1: The interval between checking the alarm temperature. (In minutes)

AT+ARTEMP: Gets or sets the alarm range of the internal temperature sensor
AT+ARTEMP=? : Gets the alarm range of the internal temperature sensor
AT+ARTEMP=45,105: Set the internal temperature sensor alarm range from 45 to 105.
AT+LEDALARM=1 : Enable LED visual Alarm.

Downlink Command:

AT+WMOD=1: A501 , AT+WMOD=0 : A600
AT+CITEMP=1 : A60001
AT+ARTEMP=1,60 : A70001003C
AT+ARTEMP=-16,60 : A7FFF0003C
AT+LEDALARM=1 : 3601

Downlink Command: AAXXXXXXXXXXXXXXX

Total bytes: 8 bytes

Example: AA0100010001003C

WMOD=01

CITEMP=0001

TEMPlow=0001

TEMPhigh=003C

DS18B20 and TMP117 Threshold Alarm

AT+WMOD=1,60,-10,20

Downlink Command:

Example: A5013CFC180014

MOD=01

CITEMP=3C(S)

TEMPlow=FC18

TEMPhigh=0014

Fluctuation alarm for DS18B20 and TMP117 (Acquisition time: minimum 1s)

AT+WMOD=2,60,5

Downlink Command:

Example: A5023C05

MOD=02

CITEMP=3C(S)

temperature fluctuation=05

Sampling multiple times and uplink together

AT+WMOD=3,1,60,20,-16,32,1

Explain:

- **parameter1:** Set Working Mode to **Mode 3**
- **parameter2:** Set the temperature sampling mode to 1(1:DS18B20;2:TMP117;3: Internal GXHT30).
- **parameter3:** Sampling Interval is **60s**.
- **parameter4:** When there is **20** sampling dats, Device will send these data via one uplink. (max value is 60, means max 60 sampling in one uplink)
- **parameter5 & parameter6:** Temperature alarm range is **-16 to 32°C**,
- **parameter7:** 1 to enable temperature alarm, **0** to disable the temperature alarm. If alarm is enabled, a data will be sent immediately if temperate exceeds the Alarr range.

Downlink Command:

Example: A50301003C14FFF0002001

MOD=03

TEMP=DS18B20

CITEMP=003C(S)

Total number of acquisitions=14

TEMPlow=FFF0

TEMPhigh=0020

ARTEMP=01

Uplink payload(Fport=3)

Example: CBEA0109920A4109C4

BatV=CBEA

TEMP=DS18B20

Temp1=0992 // 24.50°C

Temp2=0A41 // 26.25°C

Temp3=09C4 // 25.00°C

Note: This uplink will automatically select the appropriate DR according to the data length

In this mode, the temperature resolution of ds18b20 is 0.25°C to save power consumption

2.7.2 ALARM MODE (Before v1.3.1 firmware)

AT+WMOD=1: Enable/disable alarm mode. (0: Disabled, 1: Enabled Temperature Alarm for onboard temperature sensor)

AT+CITEMP=1: The interval between checking the alarm temperature. (In minutes)

AT+ARTEMP: Gets or sets the alarm range of the internal temperature sensor

AT+ARTEMP=? : Gets the alarm range of the internal temperature sensor

AT+ARTEMP=45,105: Set the internal temperature sensor alarm range from 45 to 105.

Downlink Command: AAXXXXXXXXXXXXXXX

Total bytes: 8 bytes

Example:AA0100010001003C

WMOD=01

CITEMP=0001

TEMPlow=0001

TEMPhigh=003C

2.8 LED Indicator

The LHT65 has a triple color LED which for easy showing different stage .

While user press ACT button, the LED will work as per LED status with ACT button.

In a normal working state:

- For each uplink, the BLUE LED or RED LED will blink once.
BLUE LED when external sensor is connected.
- RED LED when external sensor is not connected
- For each success downlink, the PURPLE LED will blink once

2.9 installation



3. Sensors and Accessories

3.1 E2 Extension Cable



1m long breakout cable for LHT65N. Features:

- Use for AT Command, works for both LHT52/LHT65N
- Update firmware for LHT65N, works for both LHT52/LHT65N
- Supports ADC mode to monitor external ADC
- Supports Interrupt mode
- Exposed All pins from the LHT65N Type-C connector.

LHT65N_E2 Cable Pin Mapping



3.2 E3 Temperature Probe



Temperature sensor with 2 meters cable long

- Resolution: 0.0625 °C
- $\pm 0.5^{\circ}\text{C}$ accuracy from -10°C to $+85^{\circ}\text{C}$
- $\pm 2^{\circ}\text{C}$ accuracy from -55°C to $+125^{\circ}\text{C}$
- Operating Range: $-40 \sim 125^{\circ}\text{C}$
- Working voltage 2.35v ~ 5v

3.3 E31F Temperature Probe



Temperature sensor with 1 meters cable long

Built-in Temperature Sensor:

- Resolution: 0.01 °C
- Accuracy Tolerance : Typ ± 0.3 °C
- Long Term Drift: < 0.02 °C/yr
- Operating Range: -40 ~ 80 °C

Built-in Humidity Sensor:

- Resolution: 0.04 % RH
- Accuracy Tolerance : Typ ± 3 % RH
- Long Term Drift: < 0.02 °C/yr
- Operating Range: 0 ~ 96 % RH

External Temperature Sensor :

- Resolution: 0.01 °C
- Accuracy Tolerance : Typical ± 0.3 °C
- Long Term Drift: < 0.02 °C/yr
- Operating Range: -40 ~ 125 °C

External Humidity Sensor :

- Resolution: 0.04 % RH
- Accuracy Tolerance : Typ ± 3 % RH
- Long Term Drift: < 0.02 °C/yr
- Operating Range: 0 ~ 96 % RH

4. Configure LHT65N via AT command or LoRaWAN downlink

Use can configure LHT65N via AT Command or LoRaWAN Downlink.

- AT Command Connection: See FAQ.
- LoRaWAN Downlink instruction for different platforms: IoT LoRaWAN Server (/xwiki/bin/view/Main/)

There are two kinds of commands to configure LHT65N, they are:

- **General Commands.**

These commands are to configure:

1. General system settings like: uplink interval.
2. LoRaWAN protocol & radio-related commands.

They are the same for all Dragino Devices which supports DLWS-005 LoRaWAN Stack(Note**). These commands can be found on the wiki: End Device Downlink Command (/xwiki/bin/view/Main/End%20Device%20AT%20Commands%20and%20Downlink%20Command/)

- **Commands special design for LHT65N**

These commands are only valid for LHT65N, as below:

4.1 Set Transmit Interval Time

Feature: Change LoRaWAN End Node Transmit Interval.

AT Command: AT+TDC

Command Example	Function	Response
AT+TDC=?	Show current transmit Interval	30000 OK the interval is 30000ms = 30s
AT+TDC=60000	Set Transmit Interval	OK Set transmit interval to 60000ms = 60 seconds

Downlink Command: 0x01

Format: Command Code (0x01) followed by 3 bytes time value.

If the downlink payload=0100003C, it means set the END Node's Transmit Interval to 0x00003C=60(S), while type code is 01.

- **Example 1:** Downlink Payload: 0100001E // Set Transmit Interval (TDC) = 30 seconds
- **Example 2:** Downlink Payload: 0100003C // Set Transmit Interval (TDC) = 60 seconds

4.2 Set External Sensor Mode

Feature: Change External Sensor Mode.

AT Command: AT+EXT

Command Example	Function	Response
AT+EXT=?	Get current external sensor mode	1 OK External Sensor mode =1
AT+EXT=1	Set external sensor mode to 1	
AT+EXT=9	Set to external DS18B20 with timestamp	

Downlink Command: 0xA2

Total bytes: 2 ~ 5 bytes

Example:

- 0xA201: Set external sensor type to E1
- 0xA209: Same as AT+EXT=9
- 0xA20702003c: Same as AT+SETCNT=60

4.3 Enable/Disable uplink Temperature probe ID

Feature: If PID is enabled, device will send the temperature probe ID on:

- First Packet after OTAA Join
- Every 24 hours since the first packet.

PID is default set to disable (0)

AT Command:

Command Example	Function	Response
AT+PID=1	Enable PID uplink	OK

Downlink Command:

- **0xA800** --> AT+PID=0
- **0xA801** --> AT+PID=1

4.4 Set Password

Feature: Set device password, max 9 digits

AT Command: AT+PASSWORD

Command Example	Function	Response
AT+PASSWORD=?	Show password	123456 OK
AT+PASSWORD=999999	Set password	OK

Downlink Command:

No downlink command for this feature.

4.5 Quit AT Command

Feature: Quit AT Command mode, so user needs to input password again before use AT Commands.

AT Command: AT+DISAT

Command Example	Function	Response
AT+DISAT	Quit AT Commands mode	OK

Downlink Command:

No downlink command for this feature.

4.6 Set to sleep mode

Feature: Set device to sleep mode

- **AT+Sleep=0** : Normal working mode, device will sleep and use lower power when there is no LoRa message
- **AT+Sleep=1** : Device is in deep sleep mode, no LoRa activation happen, used for storage or shipping.

AT Command: AT+SLEEP

Command Example	Function	Response
AT+SLEEP	Set to sleep mode	Clear all stored sensor data... OK

Downlink Command:

- There is no downlink command to set to Sleep mode.

4.7 Set system time

Feature: Set system time, unix format. See here for format detail.

AT Command:

Command Example	Function
AT+TIMESTAMP=1611104352	OK Set System time to 2021-01-20 00:59:12

Downlink Command:

0x306007806000 // Set timestamp to 0x(6007806000), Same as AT+TIMESTAMP=1611104352

4.8 Set Time Sync Mode

Feature: Enable/Disable Sync system time via LoRaWAN MAC Command (DeviceTimeReq), LoRaWAN server must support v1.0.3 protocol to reply this command.

SYNCMOD is set to 1 by default. If user want to set a different time from LoRaWAN server, user need to set this to 0.

AT Command:

Command Example	Function
AT+SYNCMOD=1	Enable Sync system time via LoRaWAN MAC Command (DeviceTimeReq)

Downlink Command:

0x28 01 // Same As AT+SYNCMOD=1
0x28 00 // Same As AT+SYNCMOD=0

4.9 Set Time Sync Interval

Feature: Define System time sync interval. SYNCTDC default value: 10 days.

AT Command:

Command Example	Function
AT+SYNCTDC=0x0A	Set SYNCTDC to 10 (0x0A), so the sync time is 10 days.

Downlink Command:

0x29 0A // Same as AT+SYNCTDC=0x0A

4.10 Print data entries base on page.

Feature: Print the sector data from start page to stop page (max is 416 pages).

AT Command: AT+PDTA

Command Example	Function
AT+PDTA=1,3 Print page 1 to 3	8019500 19/6/26 16:48 1 2992 sht_temp=28.21 sht_hum=71.5 ds_temp=27.31 8019510 19/6/26 16:53 1 2994 sht_temp=27.64 sht_hum=69.3 ds_temp=26.93 8019520 19/6/26 16:58 1 2996 sht_temp=28.39 sht_hum=72.0 ds_temp=27.06 8019530 19/6/26 17:03 1 2996 sht_temp=27.97 sht_hum=70.4 ds_temp=27.12 8019540 19/6/26 17:08 1 2996 sht_temp=27.80 sht_hum=72.9 ds_temp=27.06 8019550 19/6/26 17:13 1 2998 sht_temp=27.30 sht_hum=72.4 ds_temp=26.68 8019560 19/6/26 17:22 1 2992 sht_temp=26.27 sht_hum=62.3 ds_temp=26.56 8019570 8019580 8019590 80195A0 80195B0 80195C0 80195D0 80195E0 80195F0 OK

Downlink Command:

No downlink commands for feature

4.11 Print last few data entries.

Feature: Print the last few data entries

AT Command: AT+PLDTA

Command Example	Function
AT+PLDTA=5 Print last 5 entries	Stop Tx and RTP events when read sensor data 1 19/6/26 13:59 1 3005 sht_temp=27.09 sht_hum=79.5 ds_temp=26.75 2 19/6/26 14:04 1 3007 sht_temp=26.65 sht_hum=74.8 ds_temp=26.43 3 19/6/26 14:09 1 3007 sht_temp=26.91 sht_hum=77.9 ds_temp=26.56 4 19/6/26 14:15 1 3007 sht_temp=26.93 sht_hum=76.7 ds_temp=26.75 5 19/6/26 14:20 1 3007 sht_temp=26.78 sht_hum=76.6 ds_temp=26.43 Start Tx and RTP events OK

Downlink Command:

No downlink commands for feature

4.12 Clear Flash Record

Feature: Clear flash storage for data log feature.

AT Command: AT+CLRDTA

Command Example	Function	Response
AT+CLRDTA	Clear date record	Clear all stored sensor data... OK

Downlink Command: 0xA3

- Example: 0xA301 // Same as AT+CLRDTA

4.13 Auto Send None-ACK messages

Feature: LHT65N will wait for ACK for each uplink, If LHT65N doesn't get ACK from the IoT server, it will consider the message doesn't arrive server and store it. LHT65N keeps sending messages in normal periodically. Once LHT65N gets ACK from a server, it will consider the network is ok and start to send the not-arrive message.

AT Command: AT+PNACKMD

The default factory setting is 0

Command Example	Function	Response
AT+PNACKMD=1	Poll None-ACK message	OK

Downlink Command: 0x34

- Example: 0x3401 // Same as AT+PNACKMD=1

4.14 Modified WMOD command for external sensor TMP117 or DS18B20 temperature alarm (Since firmware 1.3.0)

Feature: Set internal and external temperature sensor alarms.

Command Example	Function	Response
AT+WMOD=parameter1,parameter2,parameter3,parameter4	Set internal and external temperature sensor alarms	OK

AT+WMOD=parameter1,parameter2,parameter3,parameter4

Parameter 1: Alarm mode:

- 0): Cancel
- 1): Threshold alarm
- 2): Fluctuation alarm

Parameter 2: Sampling time. Unit: seconds, up to 255 seconds.

Note: When the collection time is less than 60 seconds and always exceeds the set alarm threshold, the sending interval will not be the collection time, but will be sent every 60 seconds.

Parameter 3 and parameter 4:

1): If Alarm Mode is set to 1: Parameter 3 and parameter 4 are valid, as before, they represent low temperature and high temperature.

Such as AT+WMOD=1,60,45,105, it means high and low temperature alarm.

2): If Alarm Mode is set to 2: Parameter 3 is valid, which represents the difference between the currently collected temperature and the last uploaded temperature.

Such as AT+WMOD=2,10,2,it means that it is a fluctuation alarm.

If the difference between the current collected temperature and the last Uplink is ± 2 degrees, the alarm will be issued.

Downlink Command: 0xA5

0xA5 00 -- AT+WMOD=0.

0xA5 01 0A 11 94 29 04 -- AT+WMOD=1,10,45,105 (AT+WMOD = second byte, third byte, fourth and fifth bytes divided by 100, sixth and seventh bytes divided by 100)

0XA5 01 0A F9 C0 29 04 --AT+WMOD=1,10,-16,105(Need to convert -16 to -1600 for calculation, -1600(DEC)=FFFFFFFFF9C0(HEX) FFFFFFFFFF9C0(HEX) +10000(HEX)=F9C0(HEX))

0xA5 02 0A 02 -- AT+WMOD=2,10,2 (AT+WMOD = second byte, third byte, fourth byte)

0xA5 FF -- After the device receives it, upload the current alarm configuration (FPORT=8). Such as 01 0A 11 94 29 04 or 02 0A 02.

5. Battery & How to replace

5.1 Battery Type

LHT65N is equipped with a 2400mAh Li-MnO2 (CR17505) battery . The battery is an un-rechargeable battery with low discharge rate targeting for up to 8~10 years use. This type of battery is commonly used in IoT devices for long-term running, such as water meters.

The discharge curve is not linear so can't simply use percentage to show the battery level. Below is the battery performance.

Performance

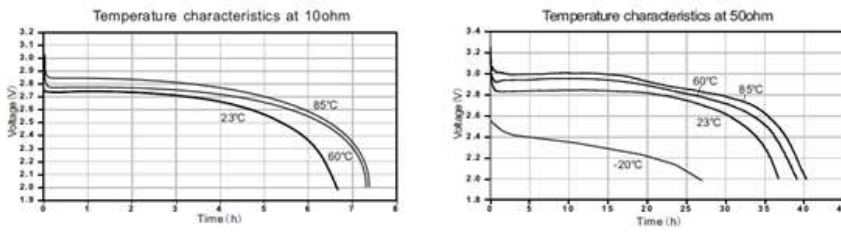

The minimum Working Voltage for the LHT65N is ~ 2.5v. When battery is lower than 2.6v, it is time to change the battery.

5.2 Replace Battery

LHT65N has two screws on the back, Unscrew them, and changing the battery inside is ok. The battery is a general CR17450 battery. Any brand should be ok.



5.3 Battery Life Analyze

Dragino battery-powered products are all run in Low Power mode. User can check the guideline from this link to calculate the estimated battery life: https://www.dragino.com/downloads/downloads/LoRa_End_Node/Battery_Analyze/DRAGINO_Battery_Life_Guide.pdf (https://www.dragino.com/downloads/downloads/LoRa_End_Node/Battery_Analyze/DRAGINO_Battery_Life_Guide.pdf)

A full detail test report for LHT65N on different frequency can be found at : <https://www.dropbox.com/sh/r2i3zlhshypavla/AAB1sZw3mdT0K7XjpHCITt13a?dl=0> (<https://www.dropbox.com/sh/r2i3zlhshypavla/AAB1sZw3mdT0K7XjpHCITt13a?dl=0>)

6. FAQ

6.1 How to use AT Command?

LHT65N supports AT Command set. User can use a USB to TTL adapter plus the Program Cable to connect to LHT65 for using AT command, as below.

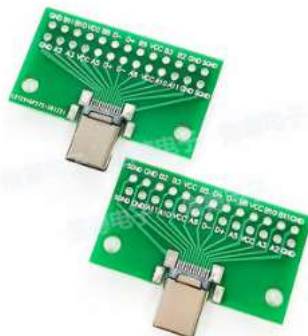

TYPE-CBeta(Male)

Connection:

- USB to TTL GND <--> GND
- USB to TTL RXD <--> D+

• USB to TTL TXD <--> A11

In PC, User needs to set serial tool(such as **putty** (<https://www.chiark.greenend.org.uk/~sgtatham/putty/latest.html>) , SecureCRT) baud rate to **9600** to access to access serial console for LHT65N. The AT commands are disable by default and need to enter password (default:**123456**) to active it. Timeout to input AT Command is 5 min, aft 5-minute, user need to input password again. User can use AT+DISAT command to disable AT command before timeout.

Input password and ATZ to activate LHT65N,As shown below:

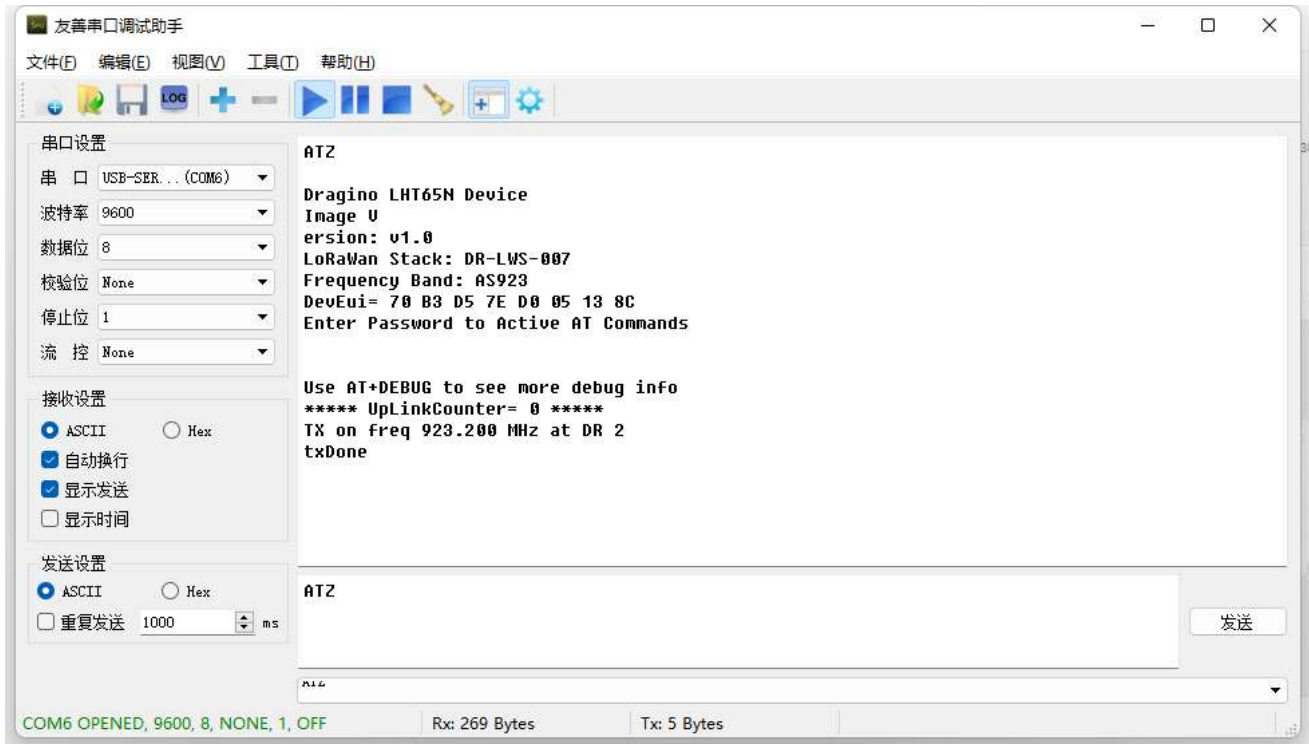

AT Command List is as below:

- AT+<CMD>? : Help on <CMD>
- AT+<CMD> : Run <CMD>
- AT+<CMD>=<value> : Set the value
- AT+<CMD>=? : Get the value
- AT+DEBUG: Set more info output
- ATZ: Trig a reset of the MCU
- AT+FDR: Reset Parameters to Factory Default, Keys Reserve
- AT+DEUI: Get or Set the Device EUI
- AT+DADDR: Get or Set the Device Address
- AT+APPKEY: Get or Set the Application Key
- AT+NWKSKEY: Get or Set the Network Session Key
- AT+APPSKEY: Get or Set the Application Session Key
- AT+APPEUI: Get or Set the Application EUI
- AT+ADR: Get or Set the Adaptive Data Rate setting. (0: off, 1: on)
- AT+TXP: Get or Set the Transmit Power (0-5, MAX:0, MIN:5, according to LoRaWAN Spec)
- AT+DR: Get or Set the Data Rate. (0-7 corresponding to DR_X)
- AT+DCS: Get or Set the ETSI Duty Cycle setting - 0=disable, 1=enable - Only for testing
- AT+PNM: Get or Set the public network mode. (0: off, 1: on)
- AT+RX2FQ: Get or Set the Rx2 window frequency
- AT+RX2DR: Get or Set the Rx2 window data rate (0-7 corresponding to DR_X)
- AT+RX1DL: Get or Set the delay between the end of the Tx and the Rx Window 1 in ms
- AT+RX2DL: Get or Set the delay between the end of the Tx and the Rx Window 2 in ms
- AT+JN1DL: Get or Set the Join Accept Delay between the end of the Tx and the Join Rx Window 1 in ms
- AT+JN2DL: Get or Set the Join Accept Delay between the end of the Tx and the Join Rx Window 2 in ms
- AT+NJM: Get or Set the Network Join Mode. (0: ABP, 1: OTAA)
- AT+NWKID: Get or Set the Network ID
- AT+FCU: Get or Set the Frame Counter Uplink

AT+FCD: Get or Set the Frame Counter Downlink
AT+CLASS: Get or Set the Device Class
AT+JOIN: Join network
AT+NJS: Get the join status
AT+SENDB: Send hexadecimal data along with the application port
AT+SEND: Send text data along with the application port
AT+RECVB: Print last received data in binary format (with hexadecimal values)
AT+RECV: Print last received data in raw format
AT+VER: Get current image version and Frequency Band
AT+CFM: Get or Set the confirmation mode (0-1)
AT+CFS: Get confirmation status of the last AT+SEND (0-1)
AT+SNR: Get the SNR of the last received packet
AT+RSSI: Get the RSSI of the last received packet
AT+TDC: Get or set the application data transmission interval in ms
AT+PORT: Get or set the application port
AT+DISAT: Disable AT commands
AT+PASSWORD: Set password, max 9 digits
AT+CHS: Get or Set Frequency (Unit: Hz) for Single Channel Mode
AT+CHE: Get or Set eight channels mode, Only for US915, AU915, CN470
AT+PDTA: Print the sector data from start page to stop page
AT+PLDTA: Print the last few sets of data
AT+CLRDTA: Clear the storage, record position back to 1st
AT+SLEEP: Set sleep mode
AT+EXT: Get or Set external sensor model
AT+BAT: Get the current battery voltage in mV
AT+CFG: Print all configurations
AT+WMOD: Get or Set Work Mode
AT+ARTEMP: Get or set the internal Temperature sensor alarm range
AT+CITEMP: Get or set the internal Temperature sensor collection interval in min
AT+SETCNT: Set the count at present
AT+RJTDC: Get or set the ReJoin data transmission interval in min
AT+RPL: Get or set response level
AT+TIMESTAMP: Get or Set UNIX timestamp in second
AT+LEAPSEC: Get or Set Leap Second
AT+SYNCMOD: Get or Set time synchronization method
AT+SYNCTDC: Get or set time synchronization interval in day
AT+PID: Get or set the PID

6.2 Where to use AT commands and Downlink commands

AT commands:

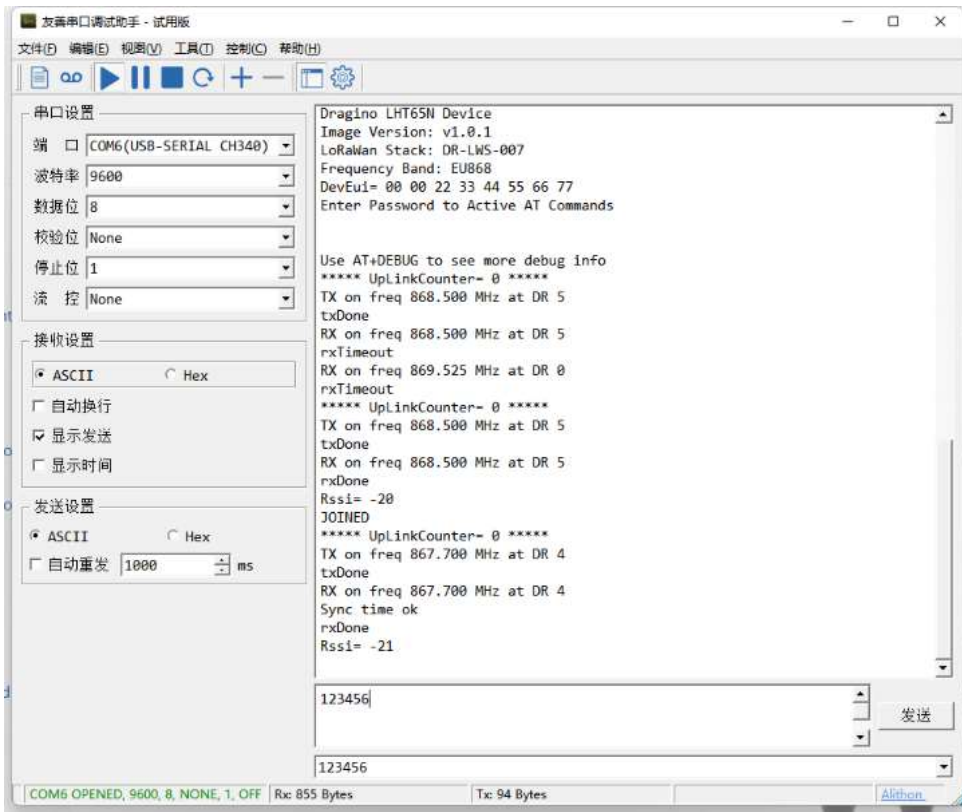

Downlink commands:

TTN:

Applications > lht111 > End devices > eui-a84041ffff1234dd

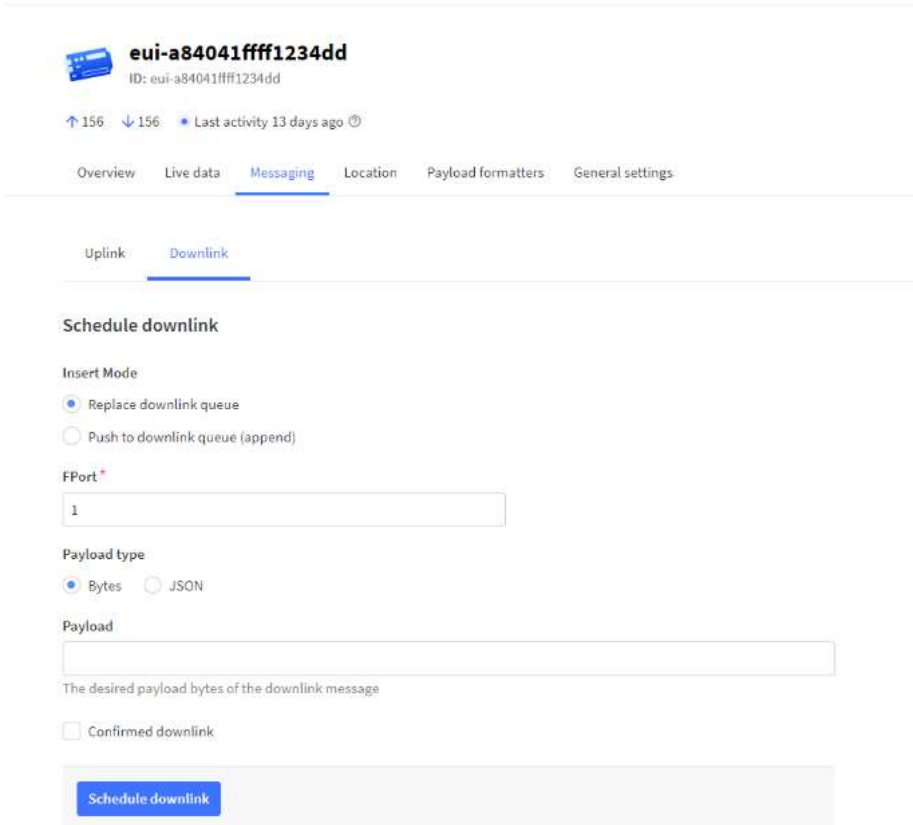

Helium:

My Devices

All Devices 1 Device

lht65 ⓘ 🗑️ Delete Device

DEVICE DETAILS		PACKETS TRANSFERRED	
		DC USED	
Name	lht65	All Time	Last 7 Days
ID	335a3e47-02e-4cnd-85ad-a28f32c299806	345	0
Device EUI	48480200181A738	Last 30 Days	Last 24 Hours
App EUI	258075345F671C56	262	0
App Key	*****		
Activation Method	OTAA		
Profile	None		

0 LABELS ATTACHED + Add Label

FLAWS +

No flows exist for this device

Chirpstack: The downlink window will not be displayed until the network is accessed

Applications / kazk / Devices / wsc1

DETAILS CONFIGURATION KEYS (OTAA)

Details

Name

Mouse drop down

Enqueue downlink payload

Port *

Please note that the Port value must be > 0

Confirmed downlink

BASE64 ENCODED JSON OBJECT

Base64 encoded string *

ENQUEUE PAYLOAD

Aws:

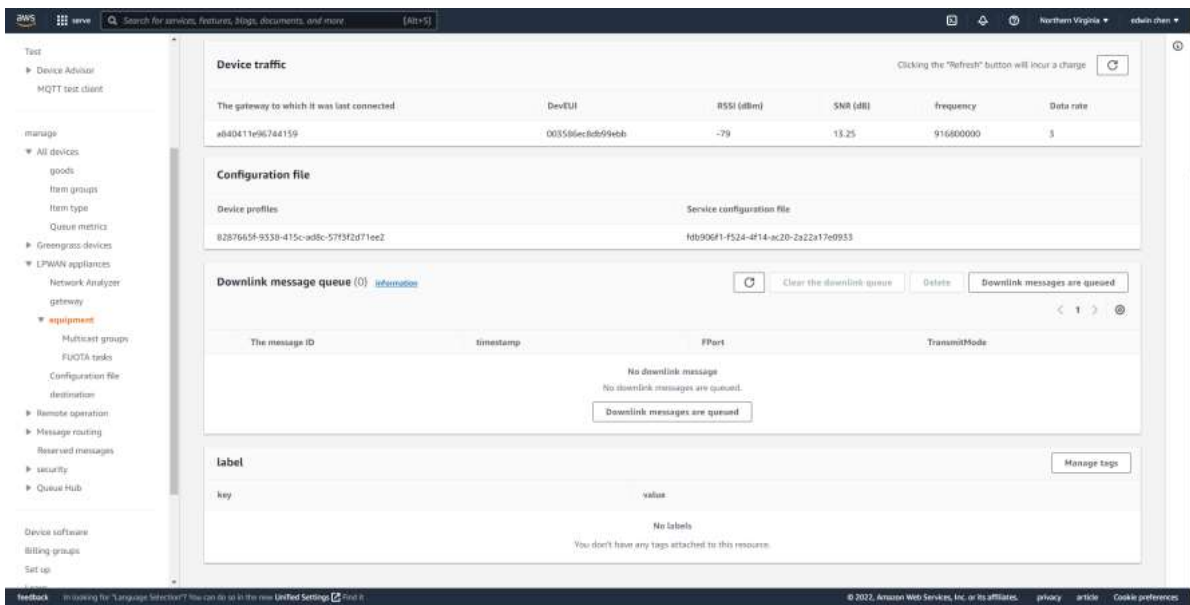

6.3 How to change the uplink interval?

Please see this link: <http://wiki.dragino.com/xwiki/bin/view/Main/How%20to%20set%20the%20transmit%20time%20interval/>
(<http://wiki.dragino.com/xwiki/bin/view/Main/How%20to%20set%20the%20transmit%20time%20interval/>)

6.4 How to use TTL-USB to connect a PC to input AT commands?

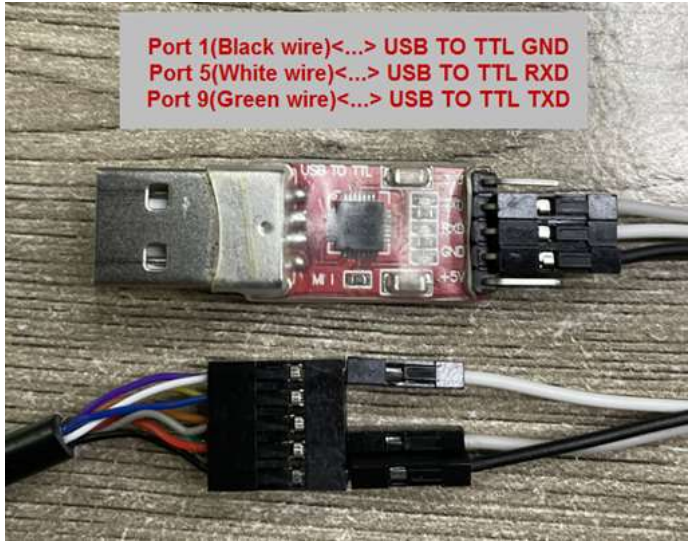
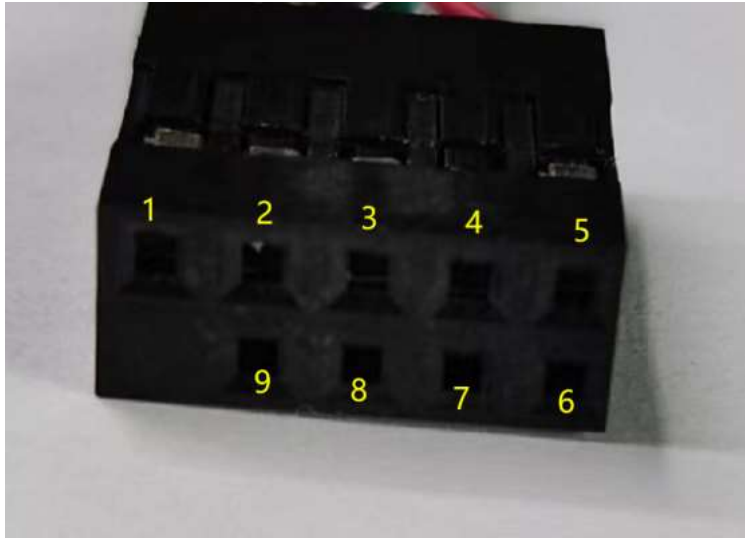

In PC, User needs to set serial tool(such as **putty** (<https://www.chiark.greenend.org.uk/~sgtatham/putty/latest.html>) , SecureCRT) baud rate to **9600** to access to access serial console for LHT65N. The AT commands are disable by default and need to enter password (default:**123456**) to activate it. Timeout to input AT Command is 5 min, aft 5-minute, user need to input password again. User can use AT+DISAT command to disable AT command before timeout.

Input password and ATZ to activate LHT65N,As shown below:

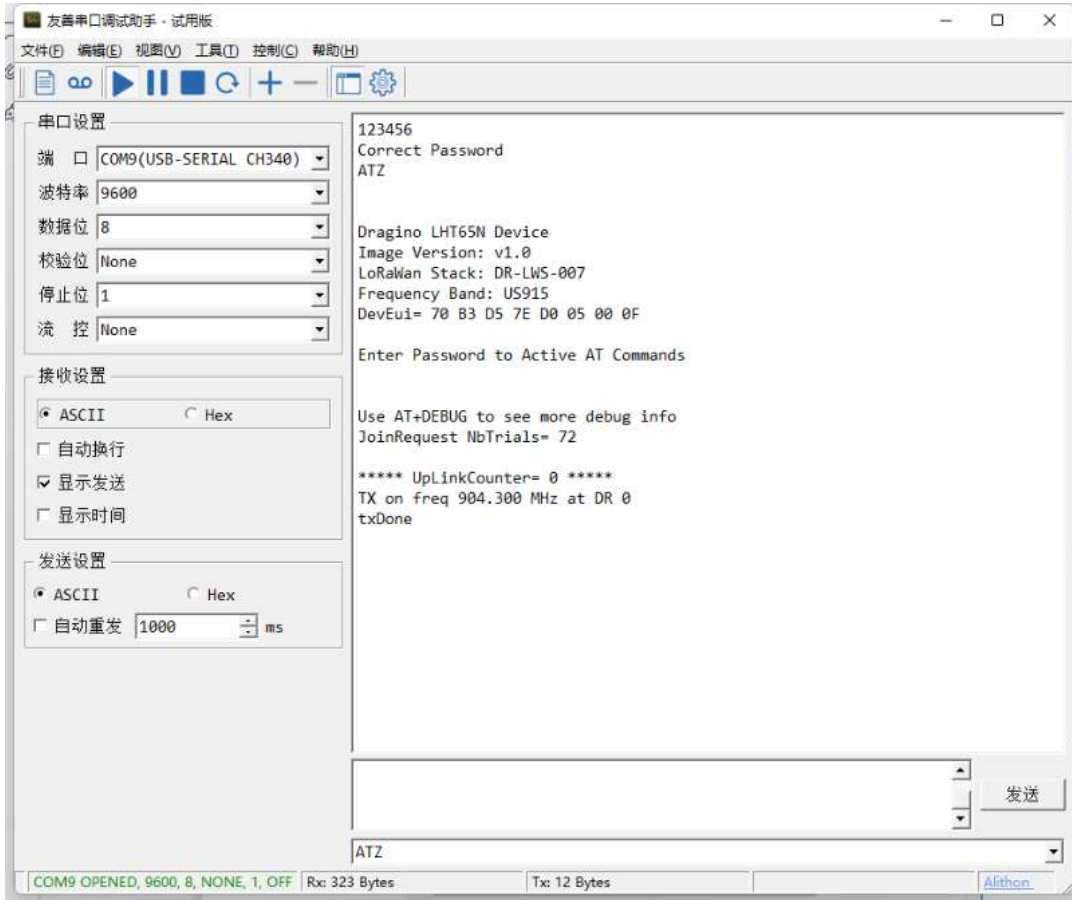

6.5 How to use TTL-USB to connect PC to upgrade firmware?

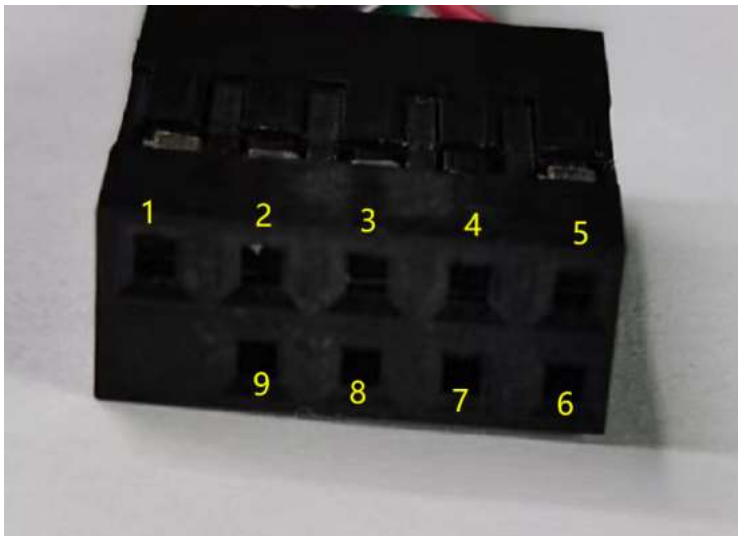

Step1: Install TremoProgrammer

(https://www.dropbox.com/sh/g99v0fxctn9r1y/AAAnJD_qGZ42bB52o4UmH9v9a/LHT65N%20Temperature%20%26%20Humidity%20Sensor/tool?dl=0&subfolder_nav_tracking=1) first.



Step2: wiring method.

First connect the four lines;



Then use DuPont cable to short circuit port3 and port1, and then release them, so that the device enters bootload mode.

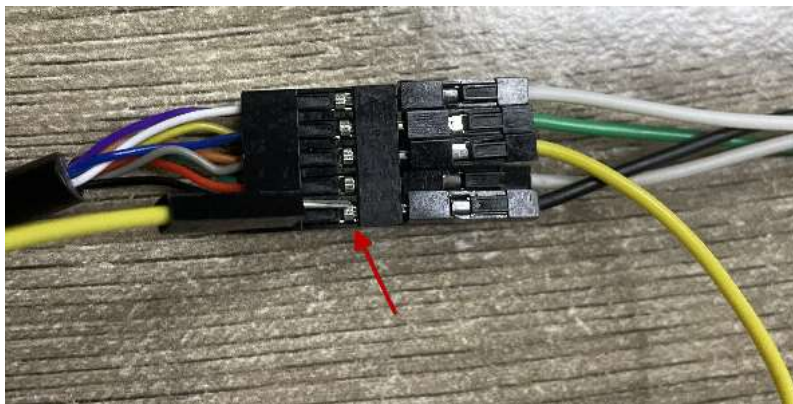

Step3: Select the device port to be connected, baud rate and bin file to be downloaded.

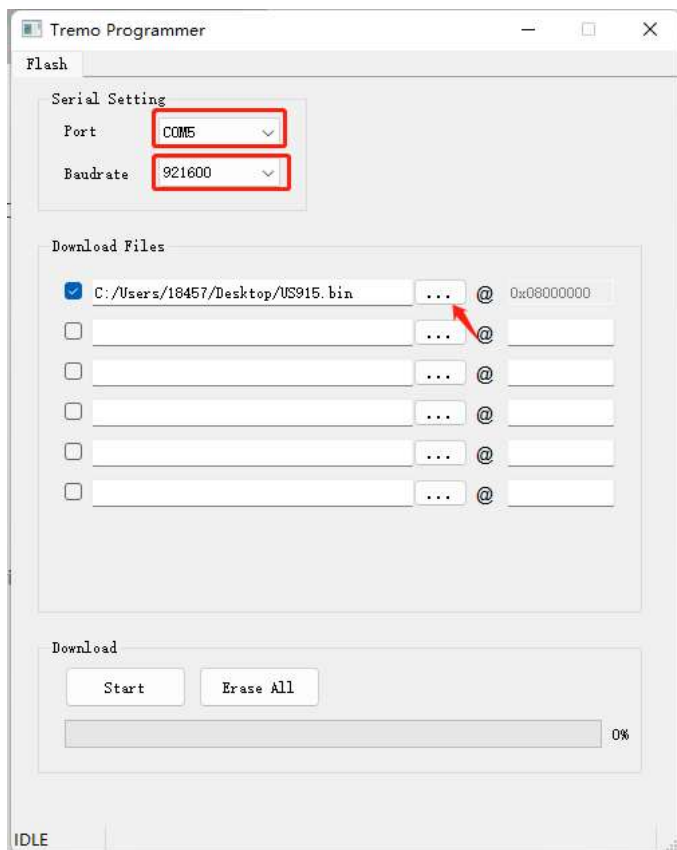

Click the **start** button to start the firmware upgrade.

When this interface appears, it indicates that the download has been completed.

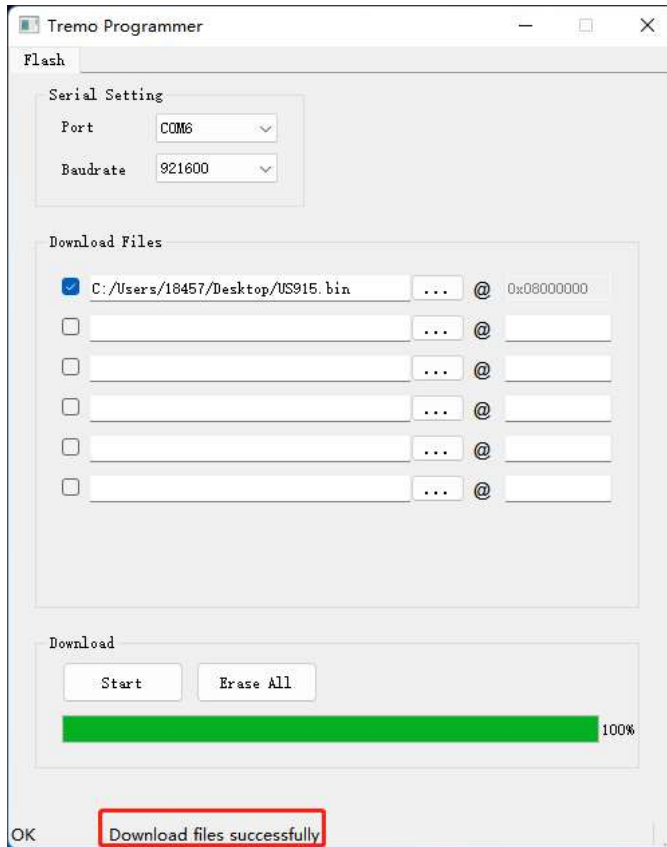

Finally, unplug the DuPont cable on port4, and then use the DuPont cable to short circuit port3 and port1 to reset the device.

6.6 Using USB-TYPE-C to connect to the computer using the AT command

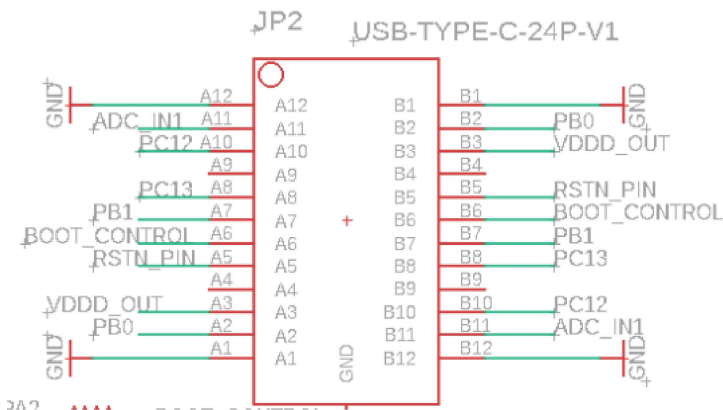

UART Port of LHT65N:

- PB0: RXD
- PB1: TXD
- GND

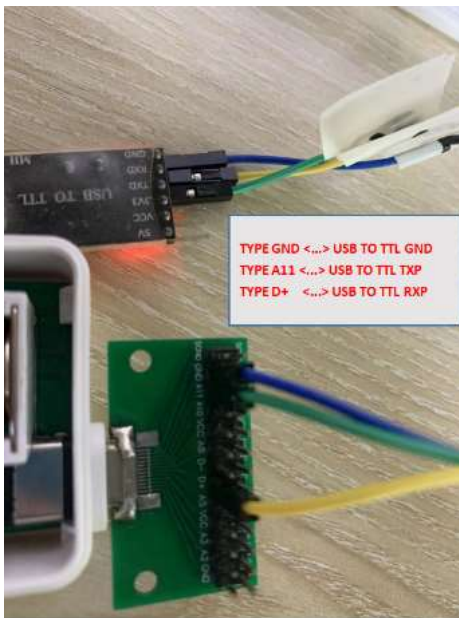

In PC, User needs to set serial tool(such as **putty** (<https://www.chiark.greenend.org.uk/~sgtatham/putty/latest.html>) , SecureCRT) baud rate to **9600** to access to access serial console for LHT65N. The AT commands are disable by default and need to enter password (default:**123456**) to activate it. Timeout to input AT Command is 5 min, aft 5-minute, user need to input password again. User can use AT+DISAT command to disable AT command before timeout.

Input password and ATZ to activate LHT65N,As shown below:

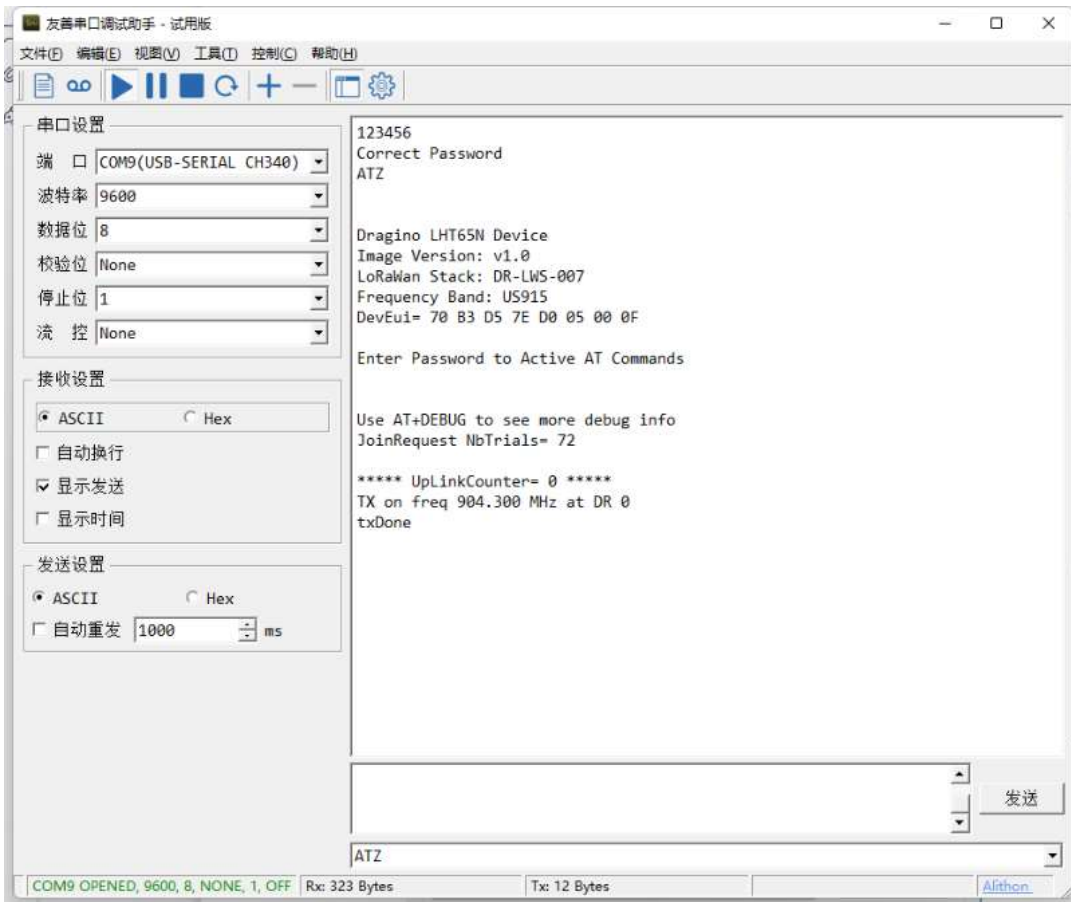

6.7 How to use USB-TYPE-C to connect PC to upgrade firmware?

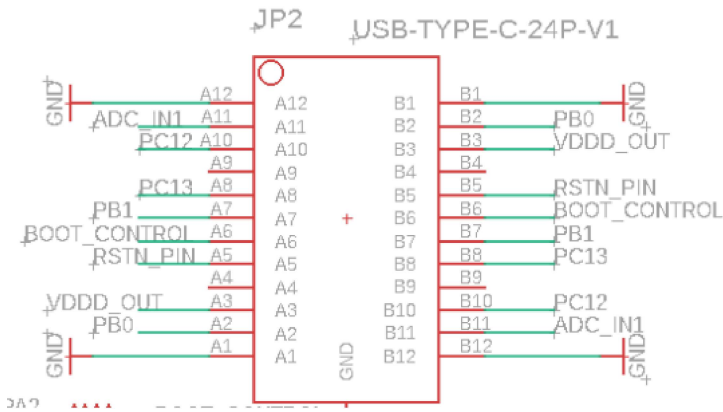

Step1: Install TremoProgrammer

(https://www.dropbox.com/sh/g99v0fxcltn9r1y/AAAnJD_qGZ42bB52o4UmH9v9a/LHT65N%20Temperature%20%26%20Humidity%20Sensor/tool?dl=0&subfolder_nav_tracking=1) first.

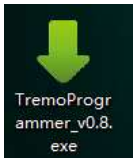

Step2: wiring method.

First connect the four lines;

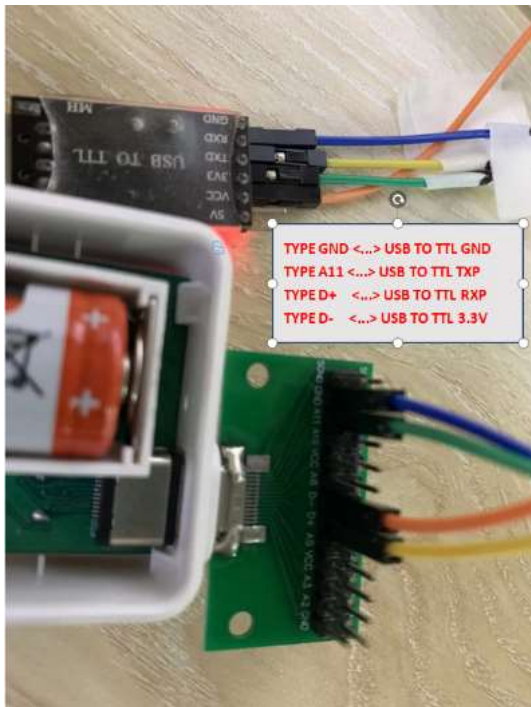

Connect A8 and GND with Dupont wire for a while and then separate, enter reset mode

Step3: Select the device port to be connected, baud rate and bin file to be downloaded.

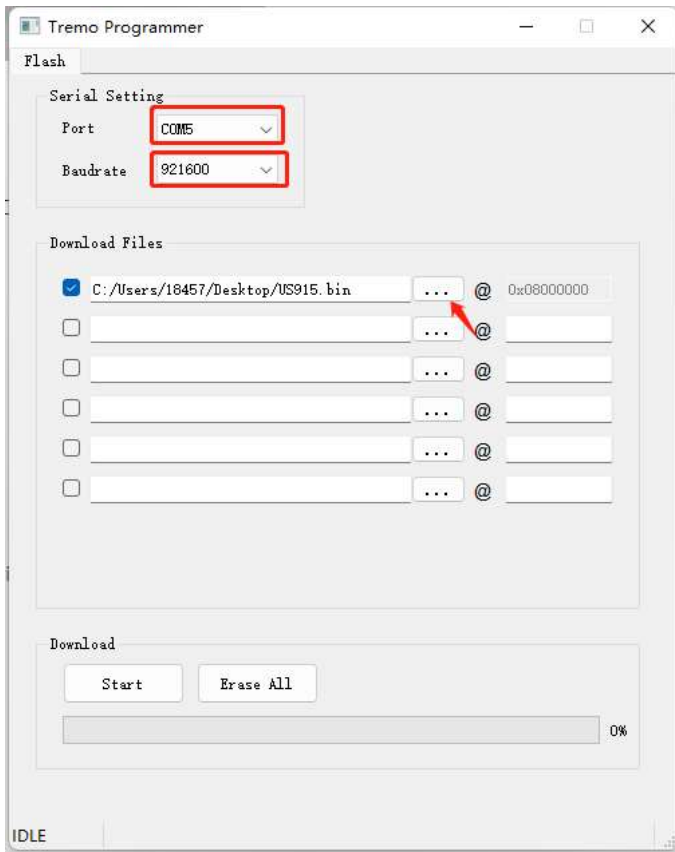

Click the **start** button to start the firmware upgrade.

When this interface appears, it indicates that the download has been completed.

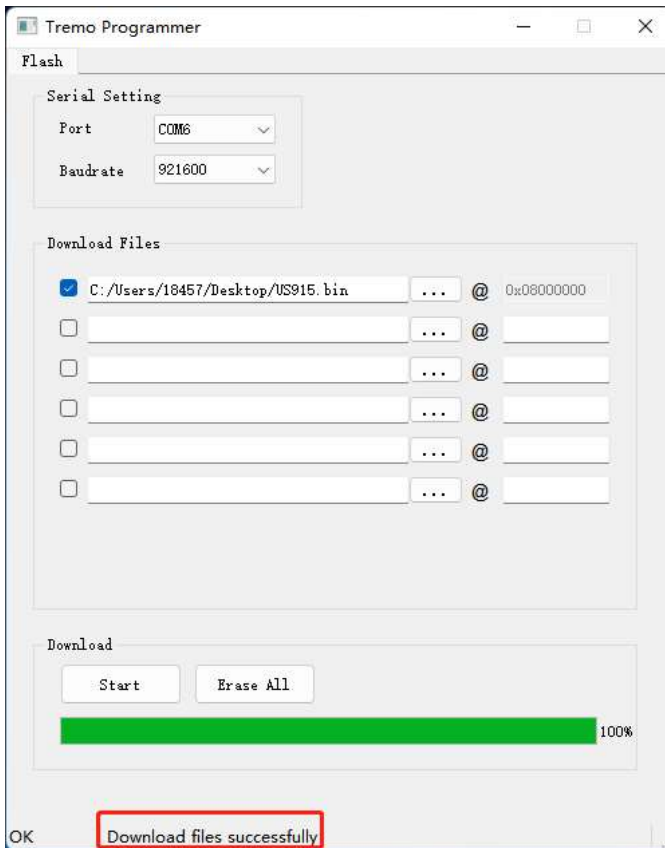

Finally, Disconnect 3.3v, Connect A8 and GND with Dupont wire for a while and then separate, exit reset mode

6.8 Why can't I see the datalog information

1. The time is not aligned, and the correct query command is not used.
2. Decoder error, did not parse the datalog data, the data was filtered.

7. Order Info

Part Number: **LHT65N-XX-YY**

XX : The default frequency band

- **AS923**: LoRaWAN AS923 band
- **AU915**: LoRaWAN AU915 band
- **EU433**: LoRaWAN EU433 band
- **EU868**: LoRaWAN EU868 band
- **KR920**: LoRaWAN KR920 band
- **US915**: LoRaWAN US915 band
- **IN865**: LoRaWAN IN865 band
- **CN470**: LoRaWAN CN470 band

YY: Sensor Accessories

- **E3**: External Temperature Probe

8. Packing Info

Package Includes:

- LHT65N Temperature & Humidity Sensor x 1
- Optional external sensor

Dimension and weight:

- Device Size: 10 x 10 x 3.5 mm
- Device Weight: 120.5g

9. Reference material

- Datasheet, photos, decoder, firmware (<https://www.dropbox.com/sh/una19zsn308dme/AACOKp6J2RF5TMIKWT5zU3RTa?dl=0>)

10. FCC Warning

This device complies with part 15 of the FCC Rules.Operation is subject to the following two conditions:

- (1) This device may not cause harmful interference;
- (2) this device must accept any interference received, including interference that may cause undesired operation.



Tags:

Created by Edwin Chen (/xwiki/bin/view/XWiki/Edwin) on 2022/05/06 20:43

No comments for this page