

DDS45-LB -- LoRaWAN Distance Detection Sensor User Manual

Last modified by Xiaoling (/xwiki/bin/view/XWiki/Xiaoling) on 2023/08/09 17:10



Table of Contents :

- 1. Introduction
 - 1.1 What is LoRaWAN Distance Detection Sensor
 - 1.2 Features
 - 1.3 Specification
 - 1.4 Rated environmental conditions
 - 1.5 Effective measurement range Reference beam pattern
 - 1.6 Applications
 - 1.7 Sleep mode and working mode
 - 1.8 Button & LEDs
 - 1.9 BLE connection
 - 1.10 Pin Definitions
 - 1.11 Mechanical
- 2. Configure DDS45-LB to connect to LoRaWAN network
 - 2.1 How it works
 - 2.2 Quick guide to connect to LoRaWAN server (OTAA)
 - 2.3 Uplink Payload
 - 2.3.1 Device Status, FPORT=5
 - 2.3.2 Battery Info
 - 2.3.3 Distance
 - 2.3.4 Interrupt Pin
 - 2.3.5 DS18B20 Temperature sensor
 - 2.3.6 Sensor Flag
 - 2.3.7 Decode payload in The Things Network
 - 2.4 Uplink Interval
 - 2.5 Show Data in DataCake IoT Server
 - 2.6 Datalog Feature
 - 2.6.1 Ways to get datalog via LoRaWAN
 - 2.6.2 Unix TimeStamp
 - 2.6.3 Set Device Time
 - 2.6.4 Poll sensor value

- 2.7 Frequency Plans
- 3. Configure DDS45-LB
 - 3.1 Configure Methods
 - 3.2 General Commands
 - 3.3 Commands special design for DDS45-LB
 - 3.3.1 Set Transmit Interval Time
 - 3.3.2 Set Interrupt Mode
- 4. Battery & Power Consumption
- 5. OTA Firmware update
- 6. FAQ
 - 6.1 What is the frequency plan for DDS45-LB?
 - 6.2 Can I use DDS45-LB in condensation environment?
- 7. Trouble Shooting
 - 7.1 Why I can't join TTN V3 in US915 / AU915 bands?
 - 7.2 AT Command input doesn't work
 - 7.3 Why does the sensor reading show 0 or "No sensor"
 - 7.4 Abnormal readings The gap between multiple readings is too large or the gap between the readings and the actual value is too large
- 8. Order Info
- 9. Packing Info
- 10. Support

1. Introduction

1.1 What is LoRaWAN Distance Detection Sensor

The Dragino DDS45-LB is a **LoRaWAN Distance Detection Sensor** for Internet of Things solution. It is used to measure the distance between the sensor and a flat object. The distance detection sensor is a module that uses **ultrasonic sensing technology** for **distance measurement**, and **temperature compensation** is performed internally to improve the reliability of data. The DDS45-LB can be applied to scenarios such as horizontal distance measurement, liquid level measurement, parking management system, object proximity and presence detection, intelligent trash can management system, robot obstacle avoidance, automatic control, sewer, bottom water level monitoring, etc. It detects the distance **between the measured object and the sensor**, and uploads the value via wireless to LoRaWAN IoT Server.

The LoRa wireless technology used in DDS45-LB allows device to send data and reach extremely long ranges at low data-rates. It provides ultra-long range spread spectrum communication and high interference immunity whilst minimizing current consumption.

DDS45-LB **supports BLE configure** and **wireless OTA update** which make user easy to use.

DDS45-LB is powered by **8500mAh Li-SOCI2 battery**, it is designed for long term use up to 5 years.

Each DDS45-LB is pre-load with a set of unique keys for LoRaWAN registrations, register these keys to local LoRaWAN server and it will auto connect after power on.

DDS45-LB in a LoRaWAN Network

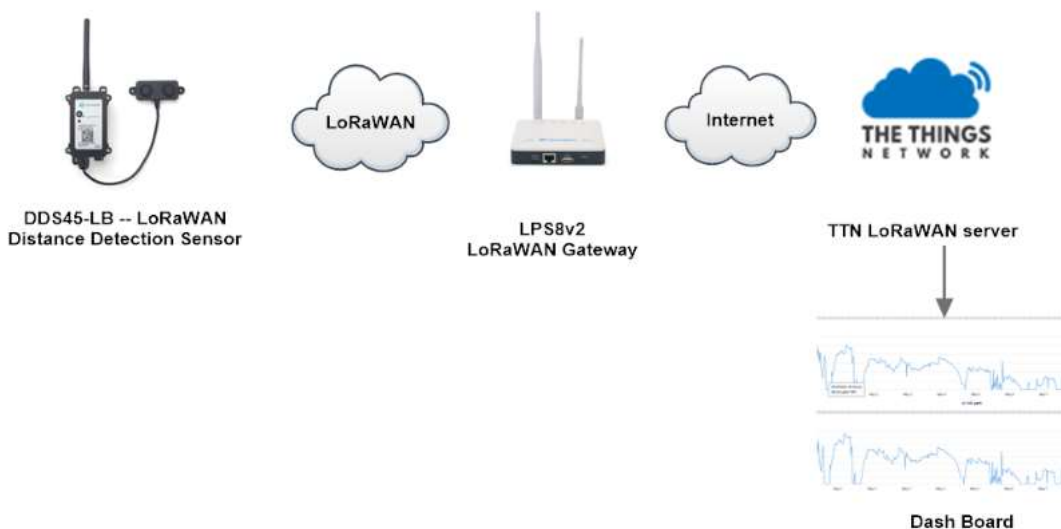

1.2 Features

- LoRaWAN 1.0.3 Class A
- Bands: CN470/EU433/KR920/US915/EU868/AS923/AU915/IN865
- Ultra-low power consumption
- Distance Detection by Ultrasonic technology
- Flat object range 30mm - 4500mm
- Accuracy: $\pm(1\text{cm}+S*0.3\%)$ (S: Distance)

- Measure Angle: 60°
- Cable Length : 25cm
- Support Bluetooth v5.1 and LoRaWAN remote configure
- Support wireless OTA update firmware
- AT Commands to change parameters
- Downlink to change configure
- IP66 Waterproof Enclosure
- 8500mAh Battery for long term use

1.3 Specification

Common DC Characteristics:

- Supply Voltage: built in 8500mAh Li-SOCI2 battery , 2.5v ~ 3.6v
- Operating Temperature: -40 ~ 85°C

LoRa Spec:

- Frequency Range, Band 1 (HF): 862 ~ 1020 Mhz
- Max +22 dBm constant RF output vs.
- RX sensitivity: down to -139 dBm.
- Excellent blocking immunity

Battery:

- Li/SOCI2 un-chargeable battery
- Capacity: 8500mAh
- Self-Discharge: <1% / Year @ 25°C
- Max continuously current: 130mA
- Max boost current: 2A, 1 second

Power Consumption

- Sleep Mode: 5uA @ 3.3v
- LoRa Transmit Mode: 125mA @ 20dBm, 82mA @ 14dBm

1.4 Rated environmental conditions

Item	Minimum value	Typical value	Maximum value	Unit	Remarks
Storage temperature	-25	25	80	°C	
Storage humidity		65%	90%	RH	(1)
Operating temperature	-15	25	60	°C	
Working humidity		65%	80%	RH	(1)

Remarks: (1) a. When the ambient temperature is 0-39 °C, the maximum humidity is 90% (non-condensing);

b. When the ambient temperature is 40-50 °C, the highest humidity is the highest humidity in the natural world at the current temperature (no condensation)

1.5 Effective measurement range Reference beam pattern

1. The tested object is a white cylindrical tube made of PVC, with a height of 100cm and a diameter of 7.5cm.

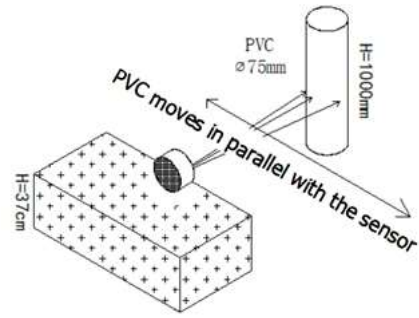
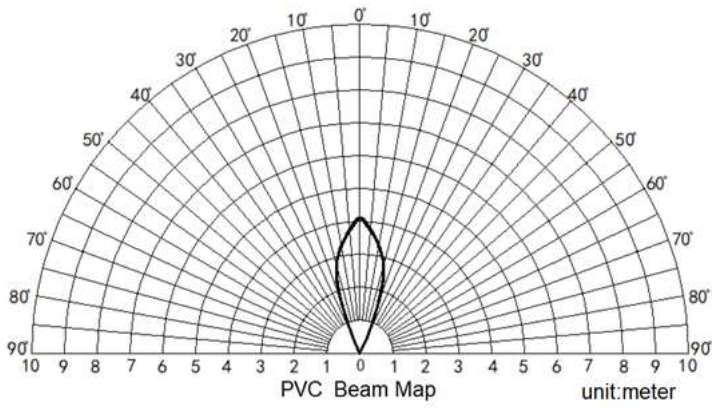

2. The object to be tested is a "corrugated cardboard box" perpendicular to the central axis of 0°, and the length * width is 60cm * 50cm.

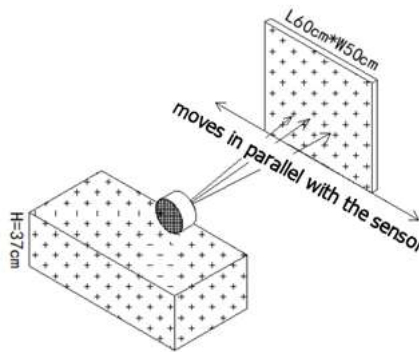
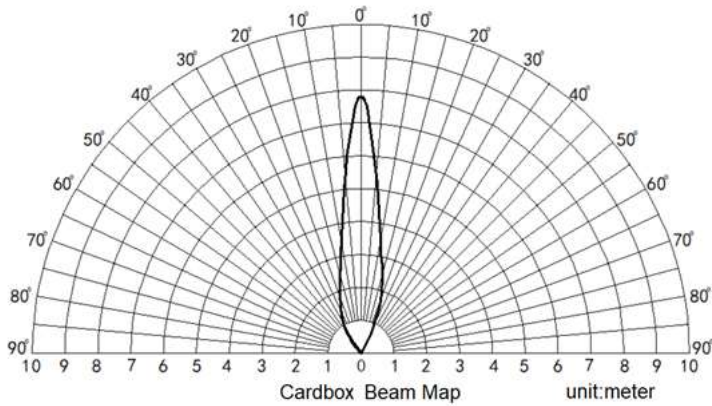

1.6 Applications

- Horizontal distance measurement
- Liquid level measurement
- Parking management system
- Object proximity and presence detection
- Intelligent trash can management system
- Robot obstacle avoidance
- Automatic control
- Sewer
- Bottom water level monitoring

1.7 Sleep mode and working mode

Deep Sleep Mode: Sensor doesn't have any LoRaWAN activate. This mode is used for storage and shipping to save battery life.

Working Mode: In this mode, Sensor will work as LoRaWAN Sensor to Join LoRaWAN network and send out sensor data to server. Between each sampling/tx/rx period sensor will be in IDLE mode), in IDLE mode, sensor has the same power consumption as Deep Sleep mode.

1.8 Button & LEDs

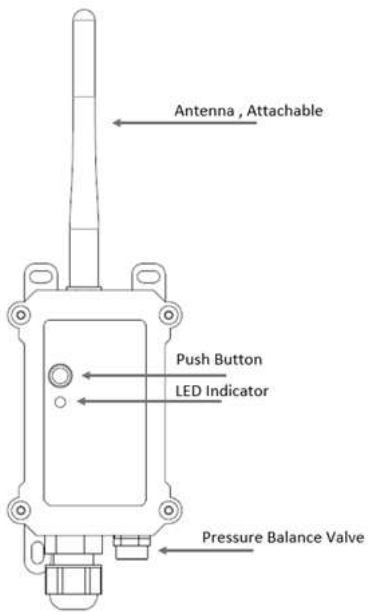

Behavior on ACT	Function	Action
Pressing ACT between 1s < time < 3s	Send an uplink	If sensor is already Joined to LoRaWAN network, sensor will send an uplink packet, blue led will blink once. Meanwhile, BLE module will be active and user can connect via BLE to configure device.
Pressing ACT for more than 3s	Active Device	Green led will fast blink 5 times, device will enter OTA mode for 3 seconds. And then start to JOIN LoRaWAN network. Green led will solidly turn on for 5 seconds after joined in network. Once sensor is active, BLE module will be active and user can connect via BLE to configure device, no matter if device join or not join LoRaWAN network.
Fast press ACT 5 times.	Deactivate Device	Red led will solid on for 5 seconds. Means device is in Deep Sleep Mode.

1.9 BLE connection

DDS45-LB support BLE remote configure.

BLE can be used to configure the parameter of sensor or see the console output from sensor. BLE will be only activate on below case:

- Press button to send an uplink
- Press button to active device.
- Device Power on or reset.

If there is no activity connection on BLE in 60 seconds, sensor will shut down BLE module to enter low power mode.

1.10 Pin Definitions

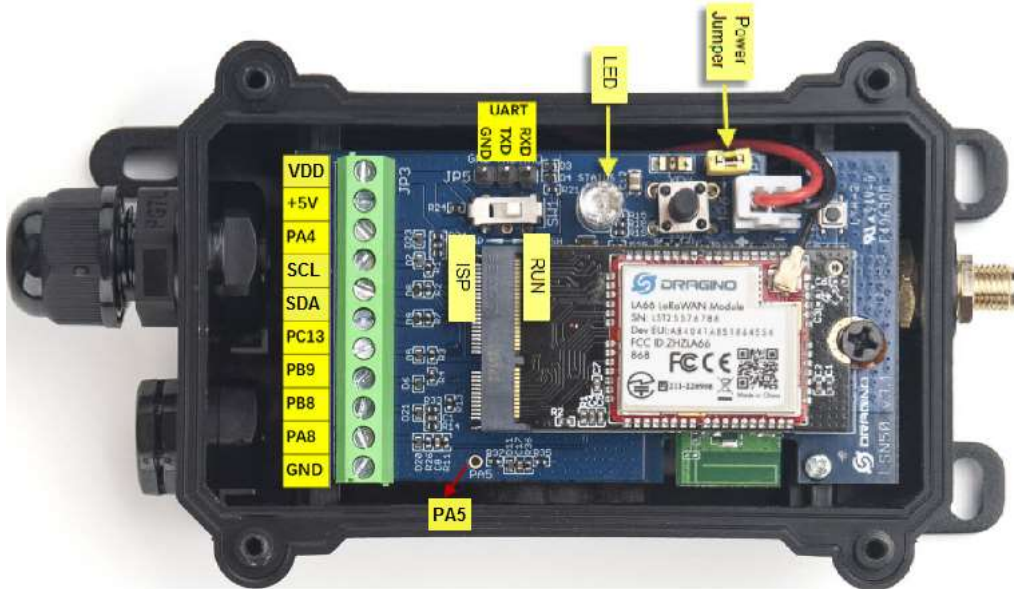

1.11 Mechanical

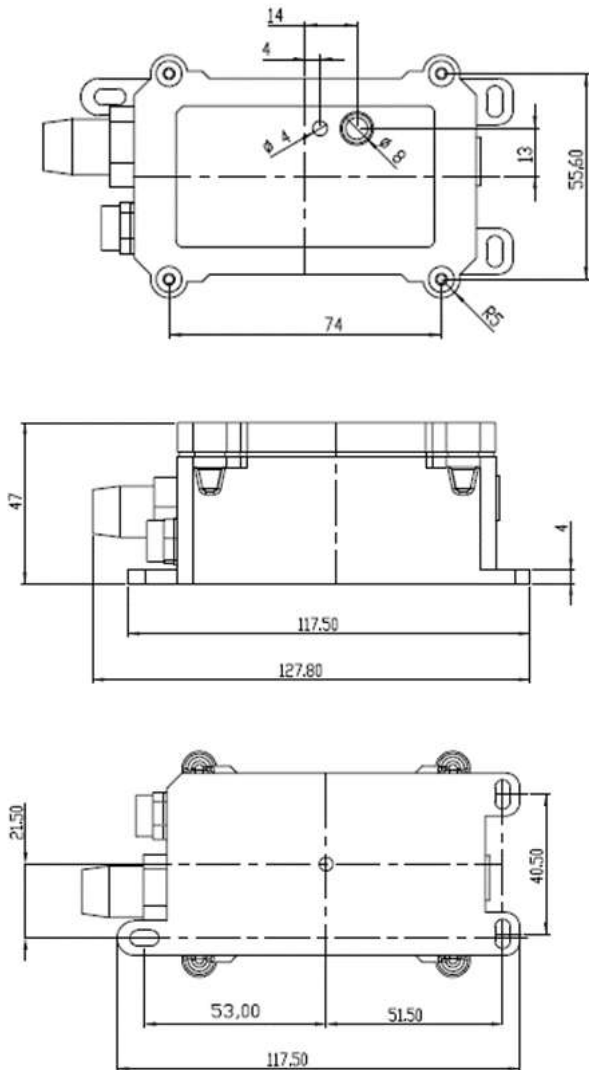

Probe Mechanical:

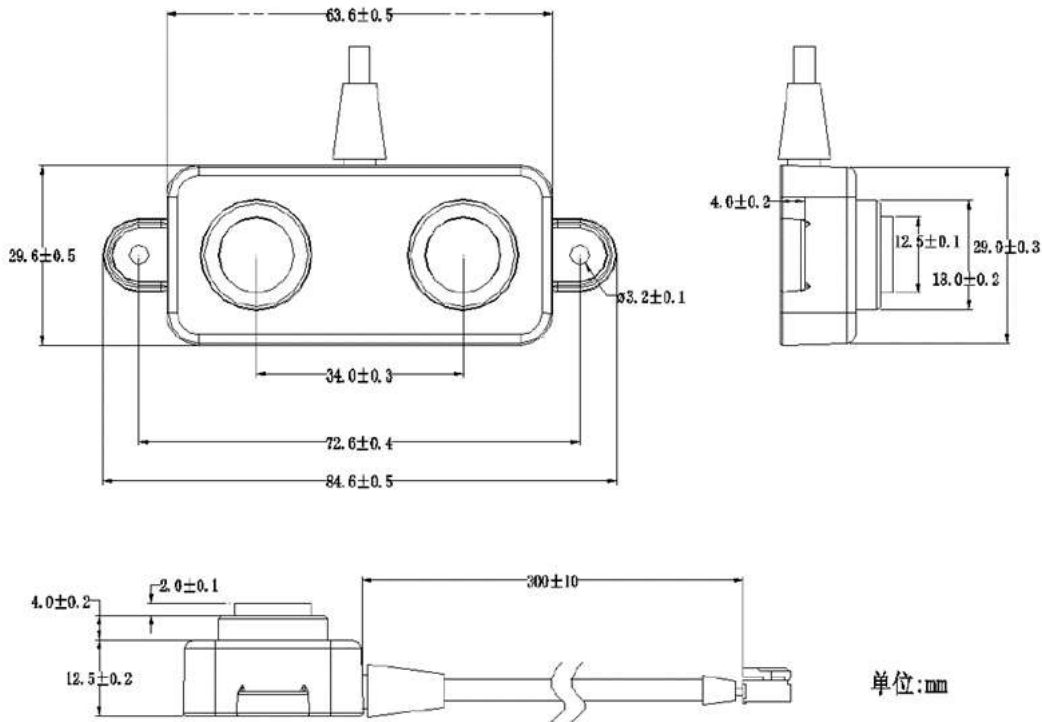

2. Configure DDS45-LB to connect to LoRaWAN network

2.1 How it works

The DDS45-LB is configured as **LoRaWAN OTAA Class A** mode by default. It has OTAA keys to join LoRaWAN network. To connect a local LoRaWAN network, you need input the OTAA keys in the LoRaWAN IoT server and press the button to activate the DDS45-LB. It will automatically join the network via OTAA and start to send the sensor value. The default uplink interval is 20 minutes.

2.2 Quick guide to connect to LoRaWAN server (OTAA)

Following is an example for how to join the TTN v3 LoRaWAN Network (<https://console.cloud.thethings.network/>). Below is the network structure; we use the LPS8v2 (<https://www.dragino.com/products/lora-lorawan-gateway/item/228-lps8v2.html>) as a LoRaWAN gateway in this example.

The LPS8v2 is already set to connected to TTN network (<https://console.cloud.thethings.network/>), so what we need to now is configure the TTN server.

DDS45-LB in a LoRaWAN Network

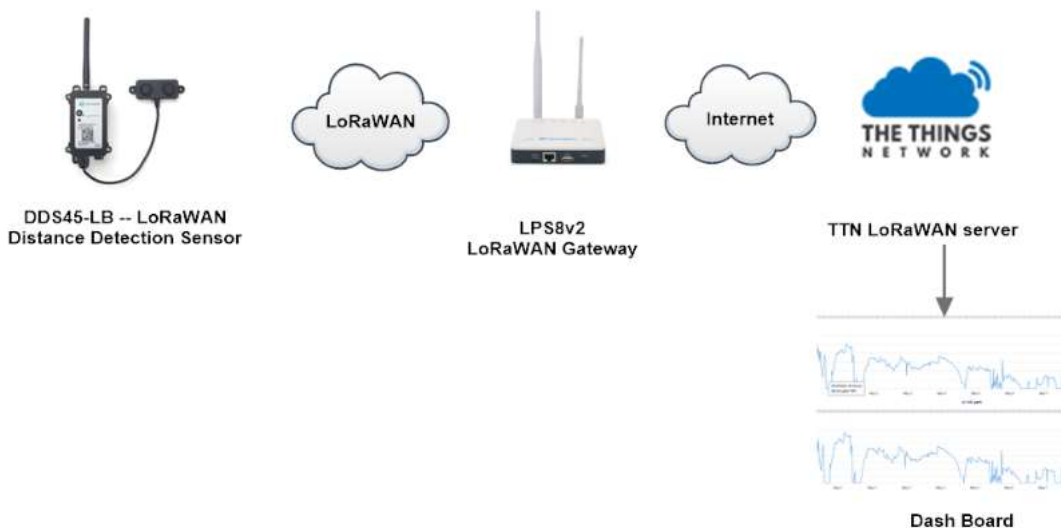

Step 1: Create a device in TTN with the OTAA keys from DDS45-LB.

Each DDS45-LB is shipped with a sticker with the default device EUI as below:



You can enter this key in the LoRaWAN Server portal. Below is TTN screen shot:

Register the device

Register end device

From The LoRaWAN Device Repository [Manually](#)

Preparation

Activation mode *

- Over the air activation (OTAA)
- Activation by personalization (ABP)
- Multicast
- Do not configure activation

LoRaWAN version ⓘ *

MAC V1.0.3 ⌵ ← 1

Network Server address
eu1.cloud.thethings.network

Application Server address
eu1.cloud.thethings.network

External Join Server ⓘ
 Enabled

Join Server address
eu1.cloud.thethings.network

Start ← 2

Add APP EUI and DEV EUI

Register end device

From The LoRaWAN Device Repository [Manually](#)

- 1 Basic settings**
End device ID's, Name and Description
- 2 Network layer settings**
Frequency plan, regional parameters, end device class and session keys.
- 3 Join settings**
Root keys, NetID and kek labels.

End device ID [?] *

AppEUI [?] *

DevEUI [?] *

End device name

End device description

Optional end device description; can also be used to save notes about the end device

[Network layer settings >](#)

Add APP EUI in the application

Register end device

From The LoRaWAN Device Repository [Manually](#)

- 1 Basic settings**
End device ID's, Name and Description
- 2 Network layer settings**
Frequency plan, regional parameters, end device class and session keys.
- 3 Join settings**
Root keys, NetID and kek labels.

Frequency plan [?] *

LoRaWAN version [?] *

Regional Parameters version [?] *

LoRaWAN class capabilities [?]

- Supports class B
- Supports class C

Advanced settings [?] v

[< Basic settings](#)

[Join settings >](#)

Add APP KEY

Register end device

From The LoRaWAN Device Repository Manually

Basic settings
 End device ID's, Name and Description

Network layer settings
 Frequency plan, regional parameters, end device class and session keys.

3 Join settings
 Root keys, NetID and kek labels.

Root keys

AppKey

BD 72 1D AC F3 CC AB 67 72 8D 7A F5 4D DF 30 8B

Advanced settings

Step 2: Activate on DDS45-LB

Press the button for 5 seconds to activate the DDS45-LB.

Green led will fast blink 5 times, device will enter **OTA mode** for 3 seconds. And then start to JOIN LoRaWAN network. **Green led** will solidly turn on for 5 seconds after join in network.

After join success, it will start to upload messages to TTN and you can see the messages in the panel.

2.3 Uplink Payload

DDS45-LB will uplink payload via LoRaWAN with below payload format:

Uplink payload includes in total 8 bytes.

Size(bytes)	2	2	1	2	1
Value	BAT	Distance (unit: mm)	Digital Interrupt (Optional)	Temperature (Optional)	Sensor Flag



2.3.1 Device Status, FPORT=5

Users can use the downlink command(0x26 01) to ask DDS45-LB to send device configure detail, include device configure status. DDS45-LB will uplink a payload via FPORT to server.

The Payload format is as below.

Device Status (FPORT=5)					
Size(bytes)	1	2	1	1	2
Value	Sensor Model	Firmware Version	Frequency Band	Sub-band	BAT

↓ 09:51:04	Schedule data downlink for transmiss...	DevAddr: 26 8B 91 8F	Rx1 Delay: 5
↑ 09:51:04	Forward uplink data message	DevAddr: 26 8B 91 8F	Payload: { BAT: 3.283, FIRMWARE_VERSION: "1.1.0", FREQUENCY_BAND: "EU868", SENSOR_MODEL: "DDS45-LB", SUB_BAND: 0 } 28 01 10 01 00 0C
↑ 09:51:04	Successfully processed data message	DevAddr: 26 8B 91 8F	
↓ 09:58:59	Schedule data downlink for transmiss...	DevAddr: 26 8B 91 8F	FPort: 1 Confirmed downlink MAC payload: 0A B3 Rx1 Delay: 5
↑ 09:58:59	Forward uplink data message	DevAddr: 26 8B 91 8F	Payload: { Bat: 3.283, Distance: 0, Interrupt_flag: 0, Sensor_flag: 0, TempC_DS18B20: "327.69" } 0C D3 00 00 00 0C CC 00
↑ 09:58:59	Successfully processed data message	DevAddr: 26 8B 91 8F	
↓ 09:58:48	Receive downlink data message	Payload: 26 01	FPort: 1

Sensor Model: For DDS45-LB, this value is 0x28

Firmware Version: 0x0100, Means: v1.0.0 version

Frequency Band:

0x01: EU868

0x02: US915

0x03: IN865

0x04: AU915

0x05: KZ865

0x06: RU864

0x07: AS923

0x08: AS923-1

0x09: AS923-2

0x0a: AS923-3

0x0b: CN470

0x0c: EU433

0x0d: KR920

0x0e: MA869

Sub-Band:

AU915 and US915: value 0x00 ~ 0x08

CN470: value 0x0B ~ 0x0C

Other Bands: Always 0x00

Battery Info:

Check the battery voltage.

Ex1: 0x0B45 = 2885mV

Ex2: 0x0B49 = 2889mV

2.3.2 Battery Info

Check the battery voltage for DDS45-LB.

Ex1: 0x0B45 = 2885mV

Ex2: 0x0B49 = 2889mV

2.3.3 Distance

Get the distance. Flat object range 30mm - 4500mm.

For example, if the data you get from the register is **0x0B 0x05**, the distance between the sensor and the measured object is

0B05(H) = 2821 (D) = 2821 mm.

- If the sensor value is 0x0000, it means system doesn't detect ultrasonic sensor.
- If the sensor value lower than 0x001E (30mm), the sensor value will be 0x00.

2.3.4 Interrupt Pin

This data field shows if this packet is generated by interrupt or not. Click here for the hardware and software set up.

Example:

0x00: Normal uplink packet.

0x01: Interrupt Uplink Packet.

2.3.5 DS18B20 Temperature sensor

This is optional, user can connect external DS18B20 sensor to the +3.3v, 1-wire and GND pin . and this field will report temperature.

Example:

If payload is: 0105H: (0105 & FC00 == 0), temp = 0105H /10 = 26.1 degree

If payload is: FF3FH : (FF3F & FC00 == 1) , temp = (FF3FH - 65536)/10 = -19.3 degrees.

2.3.6 Sensor Flag

0x01: Detect Ultrasonic Sensor

0x00: No Ultrasonic Sensor

2.3.7 Decode payload in The Things Network

While using TTN network, you can add the payload format to decode the payload.

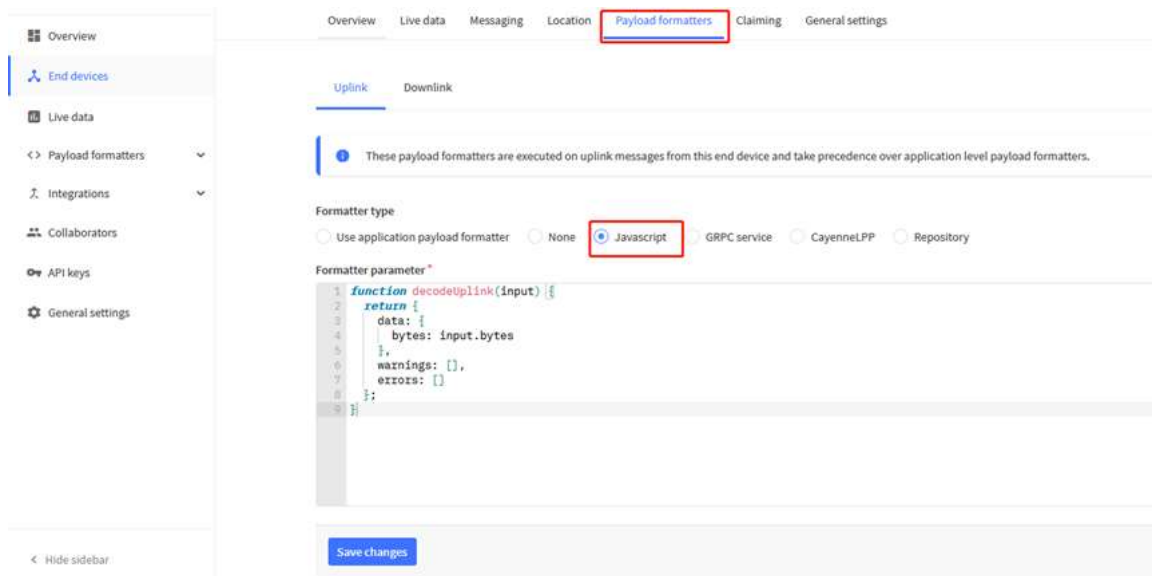

The payload decoder function for TTN V3 is here:

DDS45-LB TTN V3 Payload Decoder: <https://github.com/dragino/dragino-end-node-decoder> (<https://github.com/dragino/dragino-end-node-decoder>)

2.4 Uplink Interval

The DDS45-LB by default uplink the sensor data every 20 minutes. User can change this interval by AT Command or LoRaWAN Downlink Command. See this link: [Change Uplink Interval](#)

2.5 Show Data in DataCake IoT Server

DATAKAKE (<https://datacake.co/>) provides a human friendly interface to show the sensor data, once we have data in TTN, we can use DATAKAKE (<https://datacake.co/>) connect to TTN and see the data in DATAKAKE. Below are the steps:

Step 1: Be sure that your device is programmed and properly connected to the network at this time.

Step 2: To configure the Application to forward data to DATAKAKE you will need to add integration. To add the DATAKAKE integration, perform the following s

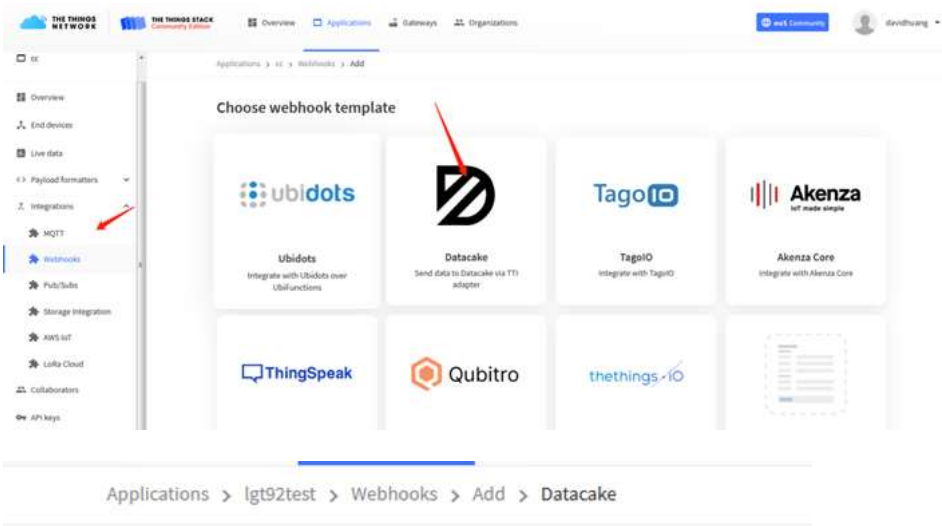

Add custom webhook

Template information



Datacake

Send data to Datacake via TTI adapter

[About Datacake](#) | [Documentation](#)

Template settings

Webhook ID *

Token *

Datacake API Token

Create datacake webhook

Step 3: Create an account or log in Datacake.

Step 4: Search the DDS45-LB and add DevEUI.

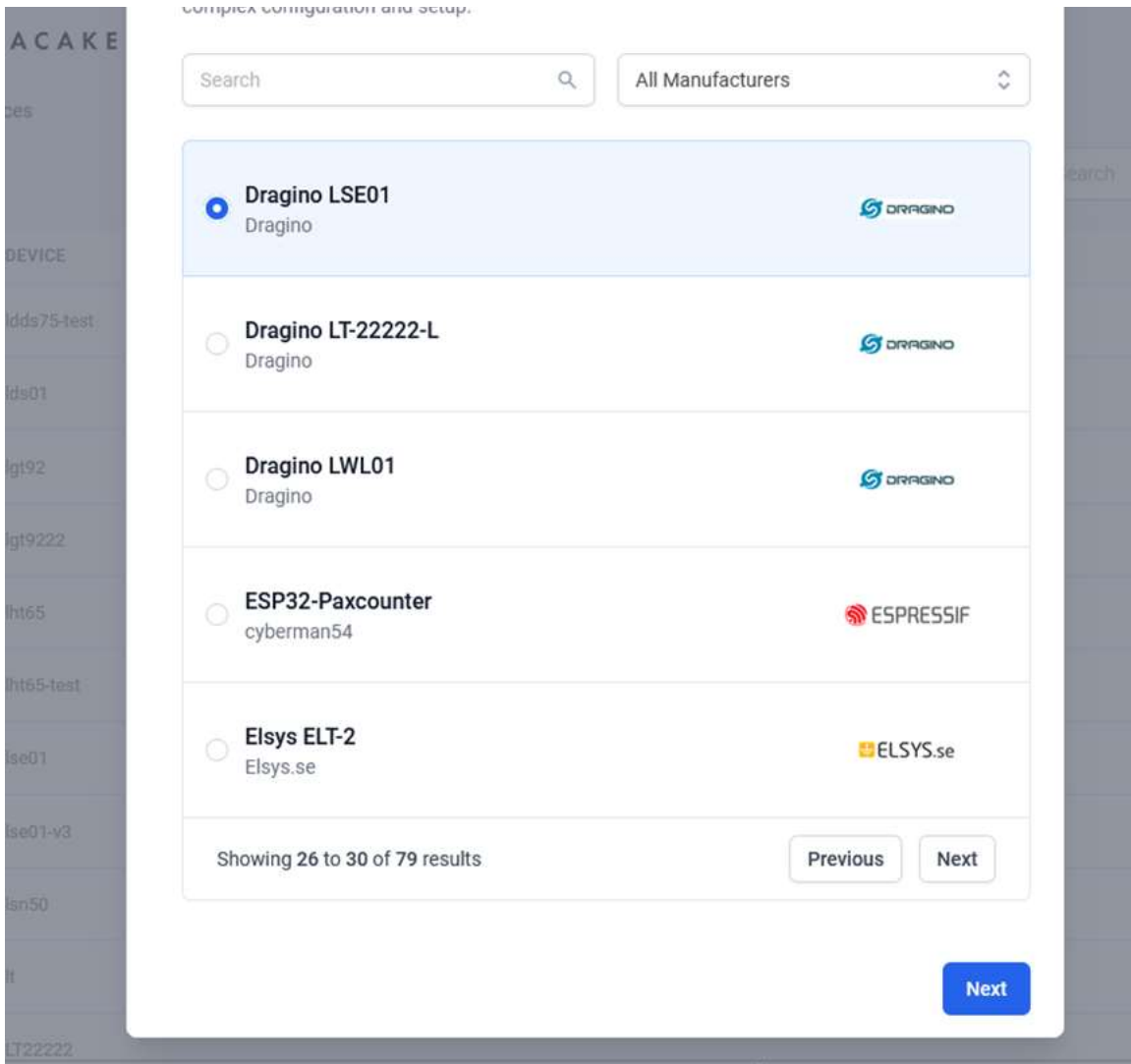

After added, the sensor data arrive TTN V3, it will also arrive and show in Datacake.

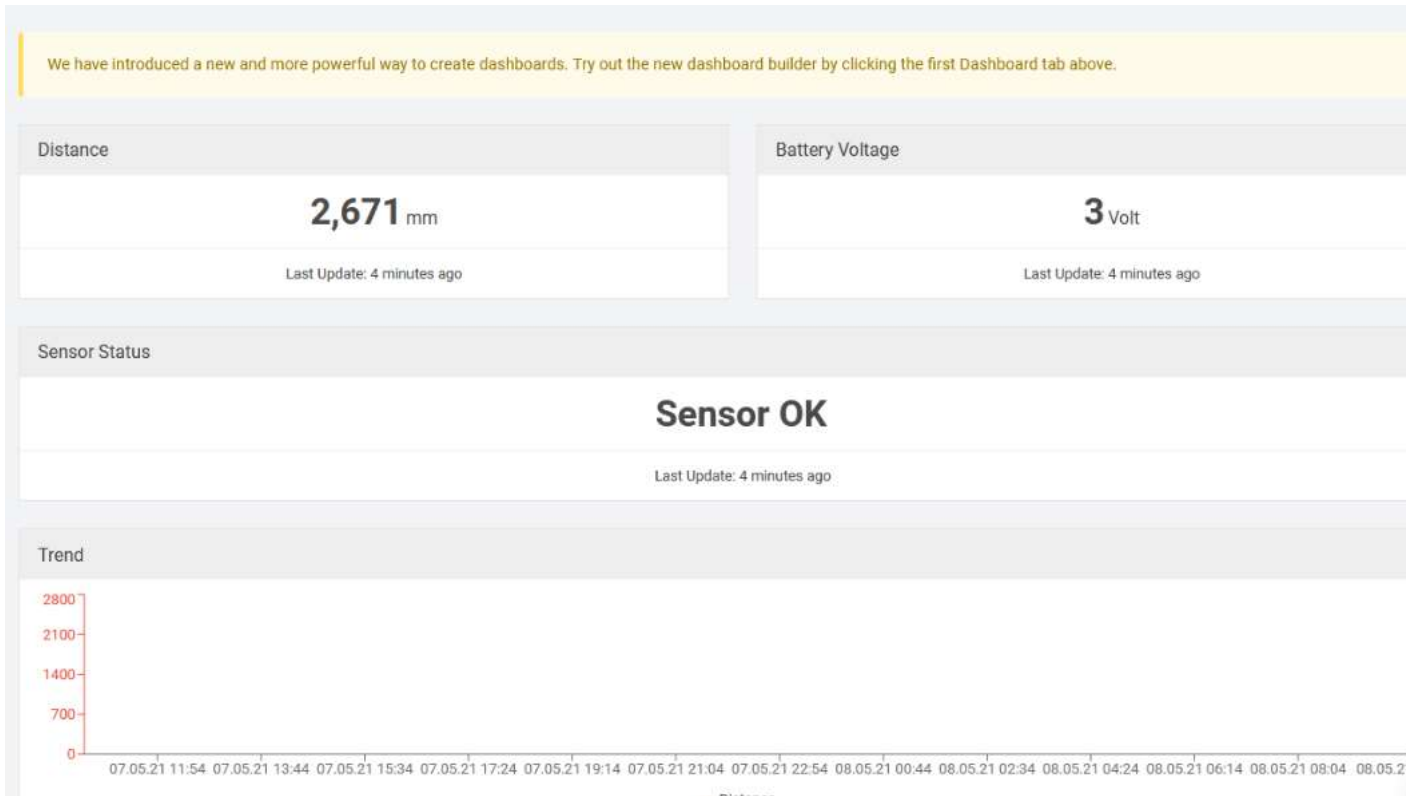

2.6 Datalog Feature

Datalog Feature is to ensure IoT Server can get all sampling data from Sensor even if the LoRaWAN network is down. For each sampling, DDS45-LB will store the reading for future retrieving purposes.

2.6.1 Ways to get datalog via LoRaWAN

Set PNACKMD=1, DDS45-LB will wait for ACK for every uplink, when there is no LoRaWAN network, DDS45-LB will mark these records with non-ack messages and store sensor data, and it will send all messages (10s interval) after the network recovery.

- a) DDS45-LB will do an ACK check for data records sending to make sure every data arrive server.
- b) DDS45-LB will send data in **CONFIRMED Mode** when PNACKMD=1, but DDS45-LB won't re-transmit the packet if it doesn't get ACK, it will just mark it as a NO ACK message. In a future uplink if DDS45-LB gets a ACK, DDS45-LB will consider there is a network connection and resend all NONE-ACK messages.

Below is the typical case for the auto-update datalog feature (Set PNACKMD=1)

New Feature for ColdChain solve network coverage issue & save cost

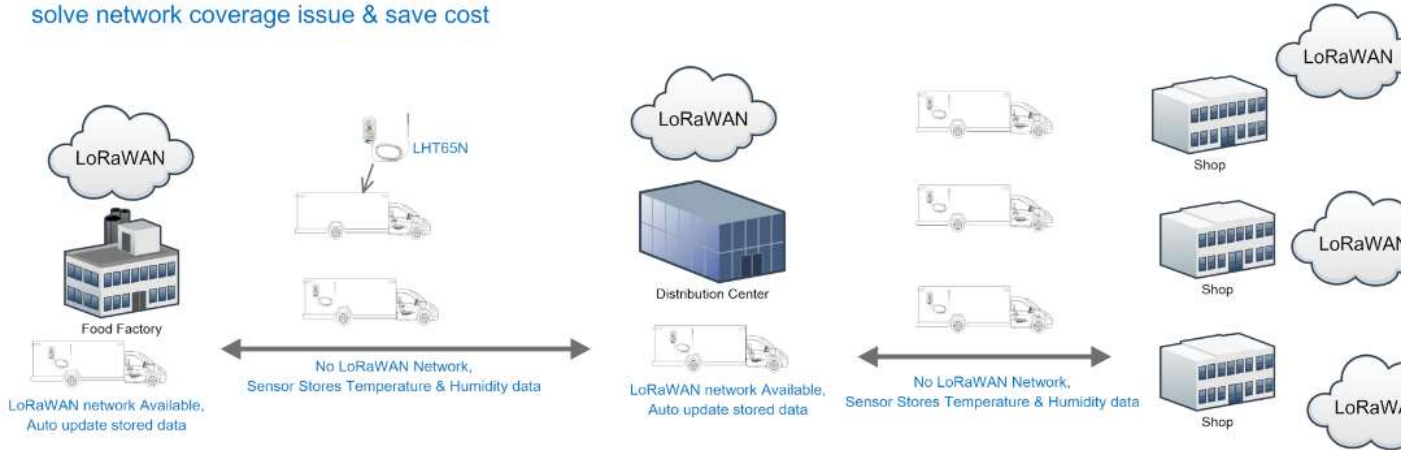

2.6.2 Unix TimeStamp

DDS45-LB uses Unix TimeStamp format based on

Size (bytes)	4	1
DeviceTimeAns Payload	32-bit unsigned integer : Seconds since epoch*	8bits unsigned integer: fractional-second in 1/2^8 second steps

Figure 10 : DeviceTimeAns payload format

User can get this time from link: <https://www.epochconverter.com/> (<https://www.epochconverter.com/>) :

Below is the converter example

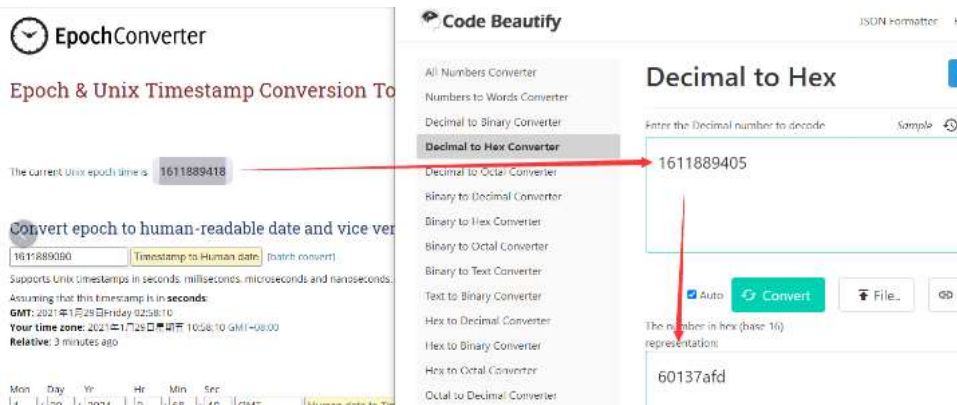

So, we can use AT+TIMESTAMP=1611889405 or downlink 3060137afd00 to set the current time 2021 – Jan -- 29 Friday 03:03:25

2.6.3 Set Device Time

User need to set **SYNCMOD=1** to enable sync time via MAC command.

Once DDS45-LB Joined LoRaWAN network, it will send the MAC command (DeviceTimeReq) and the server will reply with (DeviceTimeAns) to send the current time to DDS45-LB. If DDS45-LB fails to get the time from the server, DDS45-LB will use the internal time and wait for next time request (AT+SYNCTDC to set the time request pe default is 10 days).

Note: LoRaWAN Server need to support LoRaWAN v1.0.3(MAC v1.0.3) or higher to support this MAC command feature, Chirpstack,TTN V3 v3 and loriot suppo TTN V3 v2 doesn't support. If server doesn't support this command, it will through away uplink packet with this command, so user will lose the packet with tin request for TTN V3 v2 if SYNCMOD=1.

2.6.4 Poll sensor value

Users can poll sensor values based on timestamps. Below is the downlink command.

Downlink Command to poll Open/Close status (0x31)			
1byte	4bytes	4bytes	1byte
31	Timestamp start	Timestamp end	Uplink Interval

Timestamp start and Timestamp end-use Unix TimeStamp format as mentioned above. Devices will reply with all data logs during this period, using the uplink interval.

For example, downlink command `31 618E5740 618E8170 05`

Is to check 2021/11/12 12:00:00 to 2021/11/12 15:00:00's data

Uplink Interval =5s, means DDS45-LB will send one packet every 5s. range 5~255s.

2.7 Frequency Plans

The DDS45-LB uses OTAA mode and below frequency plans by default. If user want to use it with different frequency plan, please refer the AT command sets.

<http://wiki.dragino.com/xwiki/bin/view/Main/End%20Device%20Frequency%20Band/> (<http://wiki.dragino.com/xwiki/bin/view/Main/End%20Device%20Frequency%20Band/>)

3. Configure DDS45-LB

3.1 Configure Methods

DDS45-LB supports below configure method:

- AT Command via Bluetooth Connection (**Recommended**): BLE Configure Instruction (<http://wiki.dragino.com/xwiki/bin/view/Main/BLE%20Bluetooth%20Remote%20Configure/>) .
- AT Command via UART Connection : See UART Connection (<http://wiki.dragino.com/xwiki/bin/view/Main/UART%20Access%20for%20LoRa%20ST%20v4%20base%20model/#H2.3UARTConnectionforSN50v3basemotherbo>)
- LoRaWAN Downlink. Instruction for different platforms: See IoT LoRaWAN Server (<http://wiki.dragino.com/xwiki/bin/view/Main/>) section.

3.2 General Commands

These commands are to configure:

- General system settings like: uplink interval.
- LoRaWAN protocol & radio related command.

They are same for all Dragino Devices which support DLWS-005 LoRaWAN Stack. These commands can be found on the wiki:

<http://wiki.dragino.com/xwiki/bin/view/Main/End%20Device%20AT%20Commands%20and%20Downlink%20Command/>
<http://wiki.dragino.com/xwiki/bin/view/Main/End%20Device%20AT%20Commands%20and%20Downlink%20Command/>)

3.3 Commands special design for DDS45-LB

These commands only valid for DDS45-LB, as below:

3.3.1 Set Transmit Interval Time

Feature: Change LoRaWAN End Node Transmit Interval.

AT Command: AT+TDC

Command Example	Function	Response
AT+TDC=?	Show current transmit Interval	30000 OK the interval is 30000ms = 30s
AT+TDC=60000	Set Transmit Interval	OK Set transmit interval to 60000ms = 60 seconds

Downlink Command: 0x01

Format: Command Code (0x01) followed by 3 bytes time value.

If the downlink payload=0100003C, it means set the END Node's Transmit Interval to 0x00003C=60(S), while type code is 01.

- Example 1: Downlink Payload: 0100001E // Set Transmit Interval (TDC) = 30 seconds
- Example 2: Downlink Payload: 0100003C // Set Transmit Interval (TDC) = 60 seconds

3.3.2 Set Interrupt Mode

Feature, Set Interrupt mode for GPIO_EXTI of pin.

When AT+INTMOD=0 is set, GPIO_EXTI is used as a digital input port.

AT Command: AT+INTMOD

Command Example	Function	Response
AT+INTMOD=?	Show current interrupt mode	0 OK the mode is 0 =Disable Interrupt
AT+INTMOD=2	Set Transmit Interval 0. (Disable Interrupt), 1. (Trigger by rising and falling edge) 2. (Trigger by falling edge) 3. (Trigger by rising edge)	OK

Downlink Command: 0x06

Format: Command Code (0x06) followed by 3 bytes.

This means that the interrupt mode of the end node is set to 0x000003=3 (rising edge trigger), and the type code is 06.

- Example 1: Downlink Payload: 06000000 // Turn off interrupt mode
- Example 2: Downlink Payload: 06000003 // Set the interrupt mode to rising edge trigger

4. Battery & Power Consumption

DDS45-LB use ER26500 + SPC1520 battery pack. See below link for detail information about the battery info and how to replace.

Battery Info & Power Consumption Analyze

(<http://wiki.dragino.com/xwiki/bin/view/Main/How%20to%20calculate%20the%20battery%20life%20of%20Dragino%20sensors%3F/>)

5. OTA Firmware update

User can change firmware DDS45-LB to:

- Change Frequency band/ region.
- Update with new features.
- Fix bugs.

Firmware and changelog can be downloaded from : **Firmware download link** (<https://www.dropbox.com/sh/a5ue0nfrzqy9nz6/AABbvIATosDJKDwBmbirVbMYa?dl=>)

Methods to Update Firmware:

- (Recommended way) OTA firmware update via wireless: <http://wiki.dragino.com/xwiki/bin/view/Main/Firmware%20OTA%20Update%20for%20Sensors/>
(<http://wiki.dragino.com/xwiki/bin/view/Main/Firmware%20OTA%20Update%20for%20Sensors/>)
- Update through UART TTL interface: **Instruction**
(<http://wiki.dragino.com/xwiki/bin/view/Main/UART%20Access%20for%20LoRa%20ST%20v4%20base%20model/#H1.LoRaSTv4baseHardware>)

6. FAQ

6.1 What is the frequency plan for DDS45-LB?

DDS45-LB use the same frequency as other Dragino products. User can see the detail from this link: [Introduction](http://wiki.dragino.com/xwiki/bin/view/Main/End%20Device%20Frequency%20Band/#H1.Introduction)
(<http://wiki.dragino.com/xwiki/bin/view/Main/End%20Device%20Frequency%20Band/#H1.Introduction>)

6.2 Can I use DDS45-LB in condensation environment?

DDS45-LB is not suitable to be used in condensation environment. Condensation on the DDS45-LB probe will affect the reading and always got 0.

7. Trouble Shooting

7.1 Why I can't join TTN V3 in US915 / AU915 bands?

It is due to channel mapping. Please see below link: Frequency band
([/xwiki/bin/view/Main/LoRaWAN%20Communication%20Debug/#H2.NoticeofUS9152FCN4702FAU915Frequencyband](https://xwiki/bin/view/Main/LoRaWAN%20Communication%20Debug/#H2.NoticeofUS9152FCN4702FAU915Frequencyband))

7.2 AT Command input doesn't work

In the case if user can see the console output but can't type input to the device. Please check if you already include the **ENTER** while sending out the command. Some tool doesn't send **ENTER** while press the send key, user need to add ENTER in their string.

7.3 Why does the sensor reading show 0 or "No sensor"

1. The measurement object is very close to the sensor, but in the blind spot of the sensor.
2. Sensor wiring is disconnected
3. Not using the correct decoder

7.4 Abnormal readings The gap between multiple readings is too large or the gap between readings and the actual value is too large

- 1) Please check if there is something on the probe affecting its measurement (condensed water, volatile oil, etc.)
- 2) Does it change with temperature, temperature will affect its measurement
- 3) If abnormal data occurs, you can turn on DEBUG mode, Please use downlink or AT COMMAND to enter DEBUG mode.

downlink command: **F1 01**, AT command: **AT+DDEBUG=1**

- 4) After entering the debug mode, it will send 20 pieces of data at a time, and you can send its uplink to us for analysis

```
rk for transmi... DevAddr: 26 8B C5 28 <> FPort: 1 Confirmed downlink MAC payload: 9A 8B 37
a message Payload: F1 01 <> FPort: 1 38
rk for transmi... DevAddr: 26 8B C5 28 <> FPort: 1 Confirmed downlink MAC payload: 28 D3 39
message DevAddr: 26 8B C5 28 <> Payload: { Bat: 7.458, Distance: 19240, Interrup 42
"received_at": "2023-01-13T05:39:30.8b496324Z", 43
"uplink_message": { 44
  "session_key_id": "AYSyDjfiQesTRf147y9XP2g==", 45
  "f_port": 2, 46
  "f_cnt": 2825,
  "firm_payload": "HSIoAAAawCfAKAAqCpAKkAS0gAAAzvAAAAQ==",
  "decoded_payload": {
    "Bat": 7.458,
    "Distance": 19240,
    "Interrupt flag": 0.
```

Its original payload will be longer than other data. Even though it is being parsed, it can be seen that it is abnormal data.

Please send the data to us for check.

8. Order Info

Part Number: **DDS45-LB-XXX**

XXX: The default frequency band

- **AS923**: LoRaWAN AS923 band
- **AU915**: LoRaWAN AU915 band
- **EU433**: LoRaWAN EU433 band
- **EU868**: LoRaWAN EU868 band
- **KR920**: LoRaWAN KR920 band
- **US915**: LoRaWAN US915 band
- **IN865**: LoRaWAN IN865 band
- **CN470**: LoRaWAN CN470 band

9. Packing Info

Package Includes:

- DDS45-LB LoRaWAN Distance Detection Sensor x 1

Dimension and weight:

- Device Size: cm
- Device Weight: g
- Package Size / pcs : cm
- Weight / pcs : g

10. Support

- Support is provided Monday to Friday, from 09:00 to 18:00 GMT+8. Due to different timezones we cannot offer live support. However, your questions will be answer soon as possible in the before-mentioned schedule.
- Provide as much information as possible regarding your enquiry (product models, accurately describe your problem and steps to replicate it etc) and send a mail to Support@dragino.cc (<mailto:Support@dragino.cc>) .



Tags:

Created by Xiaoling (/xwiki/bin/view/XWiki/Xiaoling) on 2023/06/13 10:07

No comments for this page