DLOS8N - Outdoor LoRaWAN Gateway User Manual

last modified by Xiaoling

on 2022/07/06 14:58

Table of Contents

1. Introduction	5
1.1 What is the DLOS8N	5
1.2 Specifications	6
1.3 Features	7
1.4 Hardware System Structure	8
1.5 DLOS8N Applications	9
1.6 LED Indicators	9
1.7 WiFi Direction	10
2. Access and Configure DLOS8N	10
2.1 Find IP address of DLOS8N	10
2.1.1 Connect via WiFi	10
2.1.2 Connect via Ethernet with DHCP IP from router	11
2.1.3 Connect via WiFi with DHCP IP from router	11
2.1.4 Connect via Ethernet with fall back ip	12
2.2 Access Configure Web UI	12
3. Typical Network Setup	12
3.1 Overview	12
3.2 Use WAN port to access Internet	12
3.3 Access the Internet as a WiFi Client	13
3.4 Access the Internet via Cellular	13
3.5 Check Internet connection	15
4. Example: Configure as a LoRaWAN gateway	15
4.1 Create a gateway in TTN V3 Server	16
4.2 Configure DLOS8N to connect to TTN v3	20
4.3 Configure frequency	22
4.4 Add a LoRaWAN End Device	23
5. Web Configure Pages	27
5.1 Home	27
5.2 LoRa Settings	27
5.2.1 LoRa --> LoRa	27
5.2.2 LoRa --> ABP Decryption	28
5.3 LoRaWAN Settings	29
5.3.1 LoRaWAN --> LoRaWAN	29
5.3.2 LoRaWAN --> Amazon AWS-IoT	29
5.3.3 LoRaWAN --> LORIoT	29
5.4 MQTT Settings	30
5.5 System	30
5.5.1 System --> System Overview	30
5.5.2 System --> General (login settings)	31
5.5.3 System --> Network	32
5.5.4 System --> WiFi	32
5.5.5 System --> Cellular	33
5.5.6 System --> Network Status	33
5.5.7 System --> Remote Mgmt & Auto Provision	33
5.5.8 System --> Firmware Upgrade	36
5.5.9 System --> Reboot/Reset	37
5.5.10 System --> Package Maintain	37
5.6 LogRead	38
5.6.1 LogRead --> LoRa Log	38
5.6.2 LogRead --> System Log	38
6. More features	39
6.1 More instructions	39
7. Linux System	39

7.1 SSH Access for Linux console	39
7.2 Edit and Transfer files	40
7.3 File System	41
7.4 Package maintenance system	41
8. Upgrade Linux Firmware	42
9. FAQ	42
9.1 How can I configure for a customized frequency band?	42
9.2 Can I connect DLOS8N to LORIOT?	42
9.3 Can I make my own firmware for the gateway, where can I find the source code?	42
9.4 Can I use 868Mhz version for 915Mhz bands?	42
10. Trouble Shooting	42
10.1 I get kernel error when install new package, how to fix?	42
10.2 How to recover the DLOS8N if the firmware crashes	43
10.3 I configured DLOS8N for WiFi access and lost its IP. What to do now?	43
11. Order Info	44
12. Packing Info	44
13. Support	44



Table of Contents:

- [1. Introduction](#)
 - [1.1 What is the DLOS8N](#)
 - [1.2 Specifications](#)
 - [1.3 Features](#)
 - [1.4 Hardware System Structure](#)
 - [1.5 DLOS8N Applications](#)
 - [1.6 LED Indicators](#)
 - [1.7 WiFi Direction](#)
- [2. Access and Configure DLOS8N](#)
 - [2.1 Find IP address of DLOS8N](#)
 - [2.1.1 Connect via WiFi](#)
 - [2.1.2 Connect via Ethernet with DHCP IP from router](#)
 - [2.1.3 Connect via WiFi with DHCP IP from router](#)
 - [2.1.4 Connect via Ethernet with fall back ip](#)
 - [2.2 Access Configure Web UI](#)
- [3. Typical Network Setup](#)
 - [3.1 Overview](#)
 - [3.2 Use WAN port to access Internet](#)
 - [3.3 Access the Internet as a WiFi Client](#)
 - [3.4 Access the Internet via Cellular](#)
 - [3.5 Check Internet connection](#)
- [4. Example: Configure as a LoRaWAN gateway](#)
 - [4.1 Create a gateway in TTN V3 Server](#)
 - [4.2 Configure DLOS8N to connect to TTN v3](#)
 - [4.3 Configure frequency](#)
 - [4.4 Add a LoRaWAN End Device](#)

- [5. Web Configure Pages](#)
 - [5.1 Home](#)
 - [5.2 LoRa Settings](#)
 - [5.2.1 LoRa --> LoRa](#)
 - [5.2.2 LoRa --> ABP Decryption](#)
 - [5.3 LoRaWAN Settings](#)
 - [5.3.1 LoRaWAN --> LoRaWAN](#)
 - [5.3.2 LoRaWAN --> Amazon AWS-IoT](#)
 - [5.3.3 LoRaWAN --> LORIIOT](#)
 - [5.4 MQTT Settings](#)
 - [5.5 System](#)
 - [5.5.1 System --> System Overview](#)
 - [5.5.2 System --> General \(login settings\)](#)
 - [5.5.3 System --> Network](#)
 - [5.5.4 System --> WiFi](#)
 - [5.5.5 System --> Cellular](#)
 - [5.5.6 System --> Network Status](#)
 - [5.5.7 System --> Remote Mgnt & Auto Provision](#)
 - [5.5.8 System --> Firmware Upgrade](#)
 - [5.5.9 System --> Reboot/Reset](#)
 - [5.5.10 System --> Package Maintain](#)
 - [5.6 LogRead](#)
 - [5.6.1 LogRead --> LoRa Log](#)
 - [5.6.2 LogRead --> System Log](#)
- [6. More features](#)
 - [6.1 More instructions](#)
- [7. Linux System](#)
 - [7.1 SSH Access for Linux console](#)
 - [7.2 Edit and Transfer files](#)
 - [7.3 File System](#)
 - [7.4 Package maintenance system](#)
- [8. Upgrade Linux Firmware](#)
- [9. FAQ](#)
 - [9.1 How can I configure for a customized frequency band?](#)
 - [9.2 Can I connect DLOS8N to LORIIOT?](#)
 - [9.3 Can I make my own firmware for the gateway, where can I find the source code?](#)
 - [9.4 Can I use 868Mhz version for 915Mhz bands?](#)
- [10. Trouble Shooting](#)
 - [10.1 I get kernel error when install new package, how to fix?](#)
 - [10.2 How to recover the DLOS8N if the firmware crashes](#)
 - [10.3 I configured DLOS8N for WiFi access and lost its IP. What to do now?](#)
- [11. Order Info](#)
- [12. Packing Info](#)
- [13. Support](#)

1. Introduction

1.1 What is the DLOS8N

The DLOS8N is an **open source outdoor LoRaWAN Gateway**. It lets you bridge LoRa wireless network to an IP network via WiFi, Ethernet, 3G or 4G cellular. The LoRa wireless allows users to send data and reach extremely long ranges at low data-rates.

DLOS8N supports **Semtech packet forwarder** and **LoRaWAN Station connection**, it is fully compatible with LoRaWAN protocol. DLOS8N includes a **SX1302 LoRaWAN concentrator**.

DLOS8N has **pre-configured standard LoRaWAN frequency bands** to use for different countries. User can also customize the frequency bands to use in their own LoRaWAN network.

DLOS8N can communicate with ABP LoRaWAN end node without LoRaWAN server. System integrator can use it to integrate with their existing IoT Service without set up own LoRaWAN server or use 3rd party LoRaWAN service.

DLOS8N supports **auto-provision** for mass deployment and long term maintain. System intergrator can easily change the settings.

DLOS8-N In a LoRaWAN IoT Network:

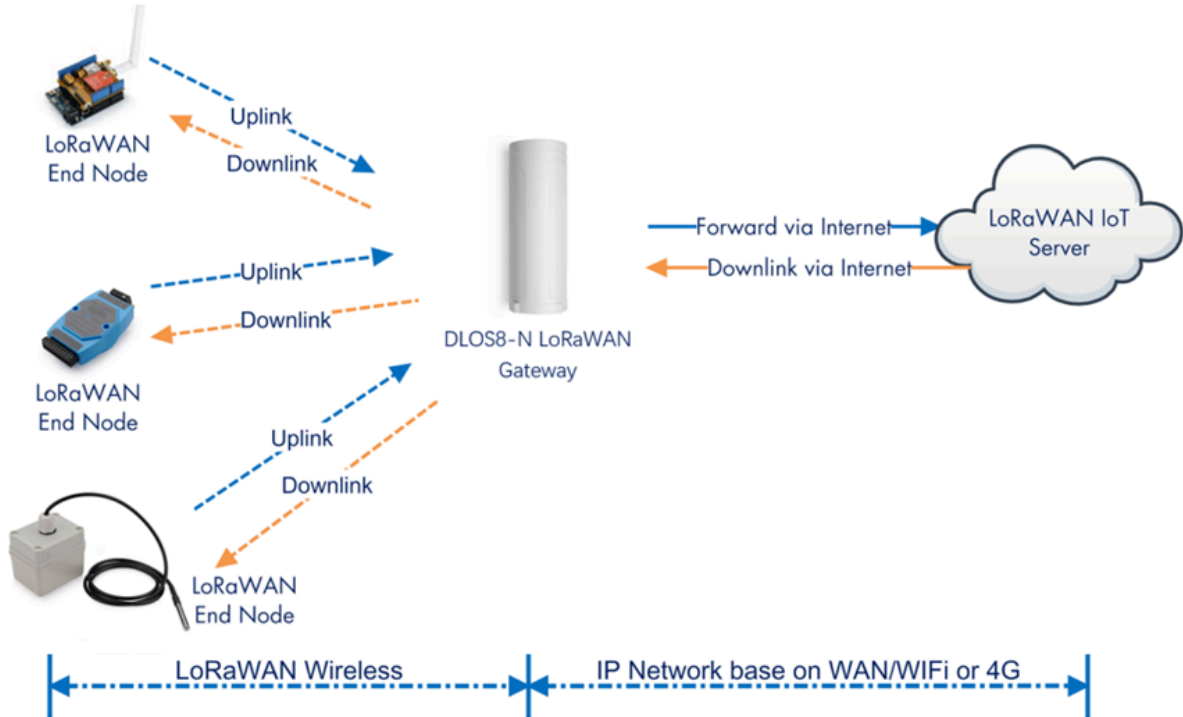

1.2 Specifications

Hardware System:

Linux Part:

- 400Mhz ar9331 processor
- 64MB RAM
- 16MB Flash

Interface:

- 10M/100M RJ45 Ports x 1
- WiFi : 802.11 b/g/n
- LoRaWAN Wireless
- Power Input: 12 ~ 24 V DC, 2 A
- IEEE 802.3 af compliant PoE port (DC 37 ~ 57 v)

- USB 2.0 host connector x 1
- Mini-PCI E connector x 1
- SX1302 + 2 x SX1250

WiFi Spec:

- IEEE 802.11 b/g/n
- Frequency Band: 2.4 ~ 2.462GHz
- Tx power:
 - 11n tx power : mcs7/15: 11db mcs0 : 17db
 - 11b tx power: 18db
 - 11g 54M tx power: 12db
 - 11g 6M tx power: 18db
- Wifi Sensitivity
 - 11g 54M : -71dbm
 - 11n 20M : -67dbm

LoRa Spec:

- Up to -140 dBm sensitivity with SX1250 Tx/Rx front-end
- 70 dB CW interferer rejection at 1 MHz offset
- Able to operate with negative SNR, CCR up to 9dB
- Emulates 49 x LoRa demodulators and 1 x (G)FSK demodulator
- Dual digital TX & RX radio front-end interfaces
- 10 programmable parallel demodulation paths
- Dynamic data-rate (DDR) adaptation
- True antenna diversity or simultaneous dual-band operation

Cellular 4G LTE (optional):

- Quectel: [EC25 LTE module](#)
- Standard Size SIM Slot
- 2 x 4G Sticker Antenna.
- Up to 150Mbps downlink and 50Mbps uplink data rates
- Worldwide LTE,UMTS/HSPA+ and GSM/GPRS/EDGE coverage
- MIMO technology meets demands for data rate and link reliability in modern wireless communication systems

Power over Ethernet:

- IEEE 802.3af compliant.
- Support wide input voltage range 37Vdc to 57Vdc.
- Thermal cut off.
- Short circuit protection.
- Over current protection
- Isolation level 4 KVrms.
- Enhanced surge protection

1.3 Features

- Open Source Embedded Linux system
- Managed by Web GUI, SSH via LAN or WiFi
- Support Semtech UDP packet forwarder
- Support LoRaWAN Station Connection
- Cellular Failover connection(option)
- Direct Communication to LoRaWAN ABP Node
- LoRaWAN packet filtering
- Far seeing LED indicator
- Built-in GPS module for location & timing
- External fiber glass antenna
- Auto-Provision
- Remote Monitoring
- 802.3af PoE

- IP65
- Lighting Protection
- Power Consumption:12v ,300-500mA

1.4 Hardware System Structure

DLOS8-N System Overview:

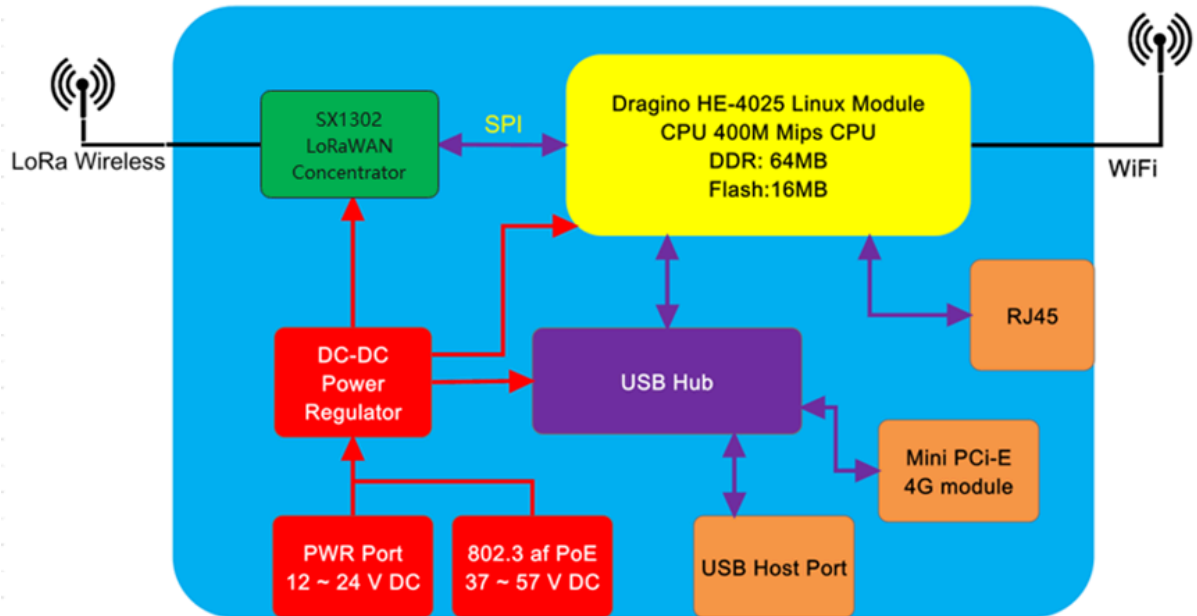

1.5 DLOS8N Applications



1.6 LED Indicators



There is a waterproof triple color LED on DLOS8N enclosure, the meaning of the LED is:

- **SOLID GREEN:** DLOS8N is alive with LoRaWAN server connection.
- **BLINKING GREEN:** a) Device has internet connection but no LoRaWAN Connection. or b) Device is in booting stage, in this stage, it will **BLINKING GREEN** for several seconds and then **RED** and **YELLOW** will blink together.
- **SOLID RED:** Device doesn't have Internet connection.

1.7 WiFi Direction

DLOS8N use directional WiFi Antenna. The best direction is as below:



2. Access and Configure DLOS8N

The DLOS8N is configured as a WiFi Access Point by default. User can access and configure the DLOS8N after connecting to its WiFi network, or via its Ethernet port.

2.1 Find IP address of DLOS8N

2.1.1 Connect via WiFi



At the first boot of DLOS8N, it will auto generate a WiFi network called **dragino-xxxxxx** with password:



dragino+dragino

User can use a PC to connect to this WiFi network. The PC will get an IP address 10.130.1.xxx and the DLOS8N has the default IP 10.130.1.1

2.1.2 Connect via Ethernet with DHCP IP from router

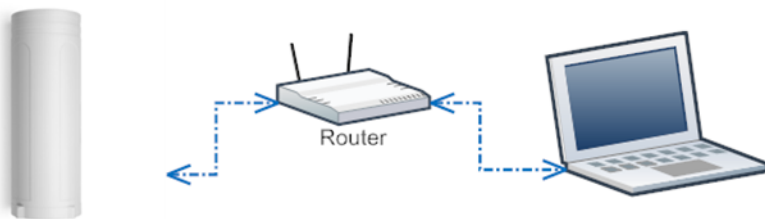

Alternatively, connect the DLOS8N Ethernet port to your router and DLOS8N will obtain an IP address from your router. In the router's management portal, you should be able to find what IP address the router has assigned to the DLOS8N. You can also use this IP to connect.

2.1.3 Connect via WiFi with DHCP IP from router



If the DLOS8N already connect to the router via WiFi, use can use the WiFi IP to connect to DLOS8N.

2.1.4 Connect via Ethernet with fall back ip

The WAN port also has a [fall back ip address](#) for access if user doesn't connect to uplink router. Click [here](#) to see how to configure.

2.2 Access Configure Web UI

Web Interface

Open a browser on the PC and type the DLOS8N ip address (depends on your connect method)

<http://10.130.1.1/> (Access via WiFi AP network)

or

http://IP_ADDRESS or [http:// IP_ADDRESS:8000](http://IP_ADDRESS:8000)

You will see the login interface of DLOS8N as shown below.

The account details for Web Login are:

User Name: root

Password: dragino

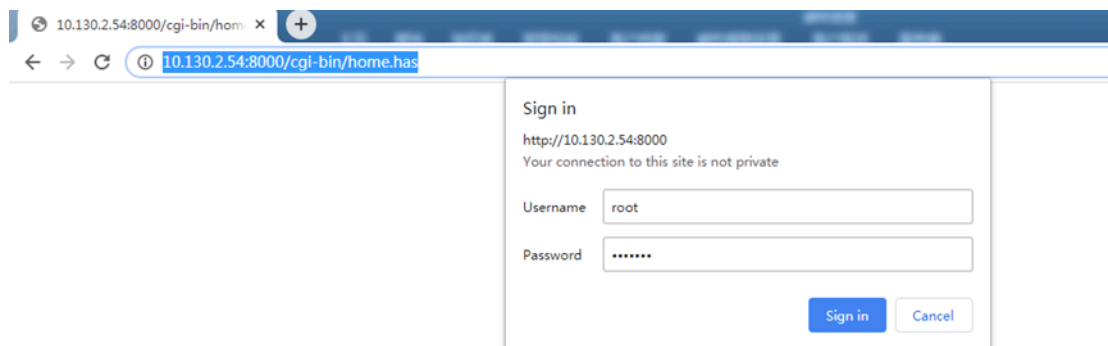

3. Typical Network Setup

3.1 Overview

The DLOS8N supports flexible network set up for different environments. This section describes the typical network topology. The network set up includes:

- **WAN Port Internet Mode**
- **WiFi Client Mode**
- **WiFi AP Mode**
- **Cellular Mode**

3.2 Use WAN port to access Internet

By default, the DLOS8N is set to use the WAN port to connect to an upstream network. When you connect the DLOS8N's WAN port to an upstream router, DLOS8N will get an IP address from the router and have Internet access via the upstream router. The network status can be checked in the [home page](#):

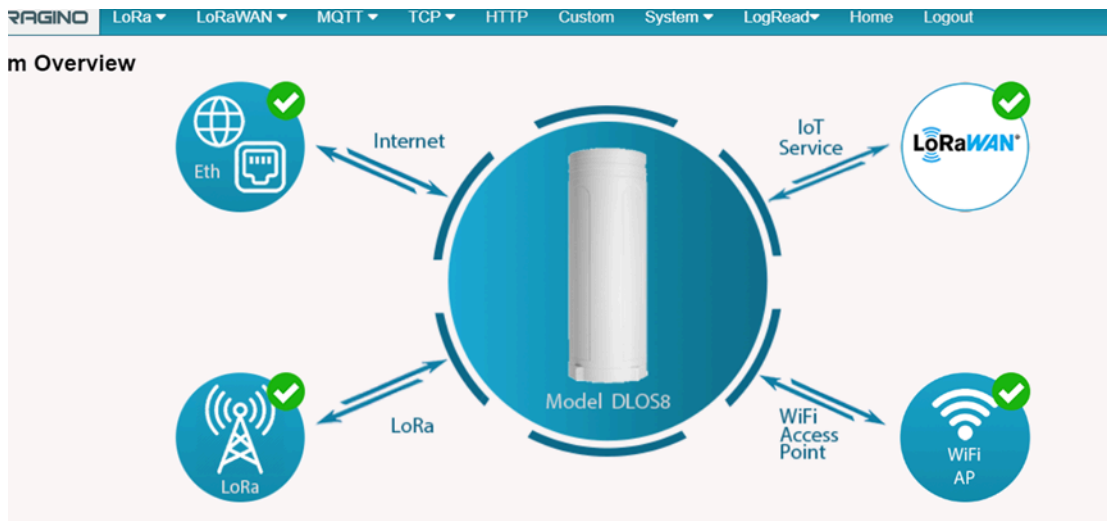

3.3 Access the Internet as a WiFi Client

In the WiFi Client Mode, DLOS8N acts as a WiFi client and gets DHCP from an upstream router via WiFi.

The settings for WiFi Client is under page [System--> WiFi --> WiFi WAN Client Settings](#)

WiFi

Radio Settings

Channel (1-11) Tx Power (0-18) dBm

WiFi Access Point Settings

Enable WiFi Access Point

WiFi Name SSID

Passphrase (8-32 char) [Show](#) Encryption

WiFi WAN Client Settings

Enable WiFi WAN Client

Host WiFi SSID

Passphrase [Show](#) WiFi Survey

Encryption

In the WiFi Survey Choose the WiFi AP, and input the Passphrase then click Save & Apply to connect.

3.4 Access the Internet via Cellular

If the DLOS8N support 3G/4G Cellular modem option, When the label on the shell is displayed as Model : DLOS8N-EC25, it indicates that DLOS8 already has EC25 3G/4G modules,user can use it as main internet connection or back up.

First, release the four screws of DLOS8N, pull out PCB and install SIM card as below:

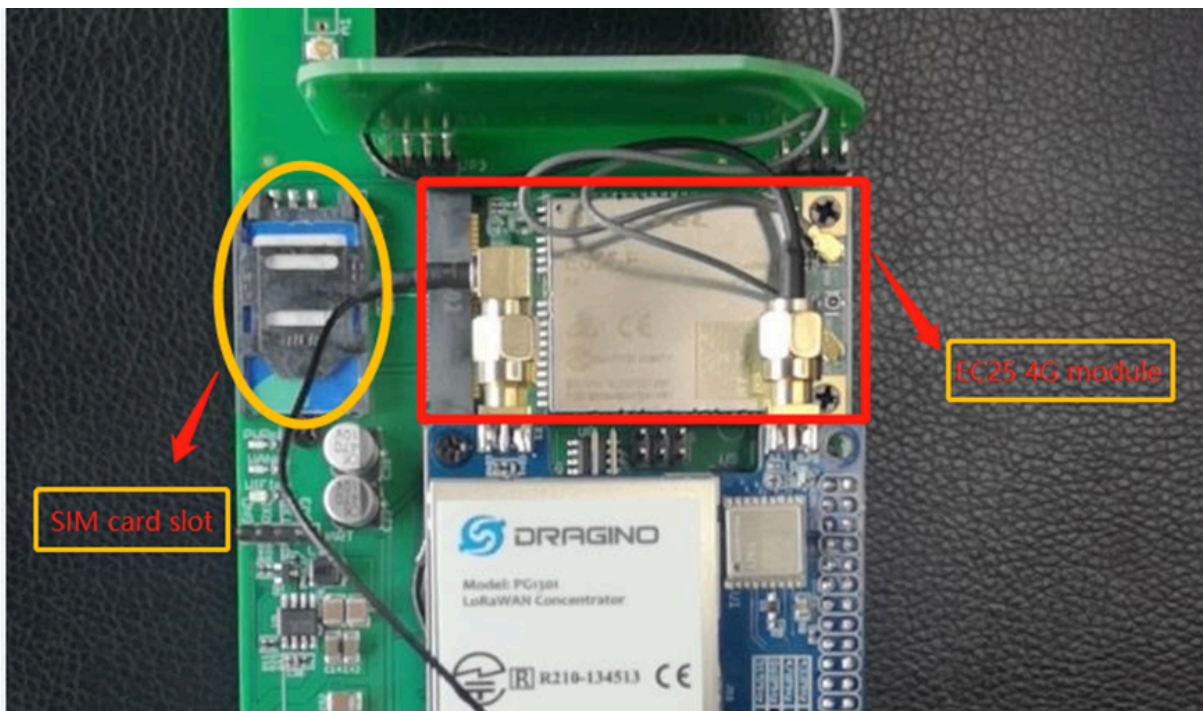

The set up page is [System --> Cellular](#)

While use the cellular as Backup WAN, device will use Cellular for internet connection while WAN port or WiFi is not valid and switch back to WAN port or WiFi after they recover.

Cellular Settings

Enable Cellular WAN
 Use Cellular as Backup WAN

APN

Service

Dial Number

Pincode



Username

Password

Note *: For DLOS8N which doesn't have the cellular module, this page will shows Cellular not detected.

3.5 Check Internet connection

In the [home](#) page, we can check the Internet connection.

- GREEN Tick  : This interface has Internet connection.
- Yellow Tick  : This interface has IP address but don't use it for internet connection.
- RED Cross  : This interface doesn't connected.

Overview

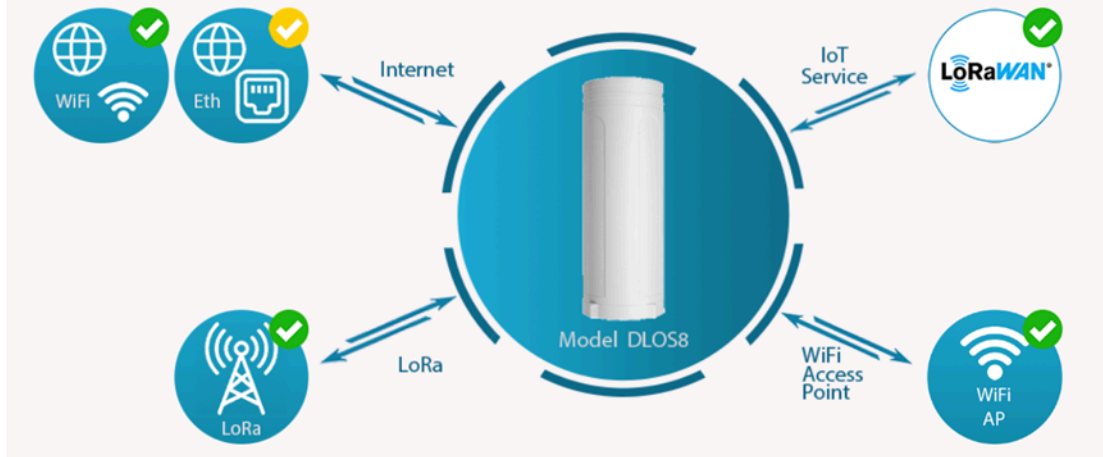

4. Example: Configure as a LoRaWAN gateway

DLOS8N is fully compatible with LoRaWAN protocol. It uses the legacy Semtech Packet forwarder to forward the LoRaWAN packets to server. The structure is as below.

DLOS8N In a LoRaWAN IoT Network:

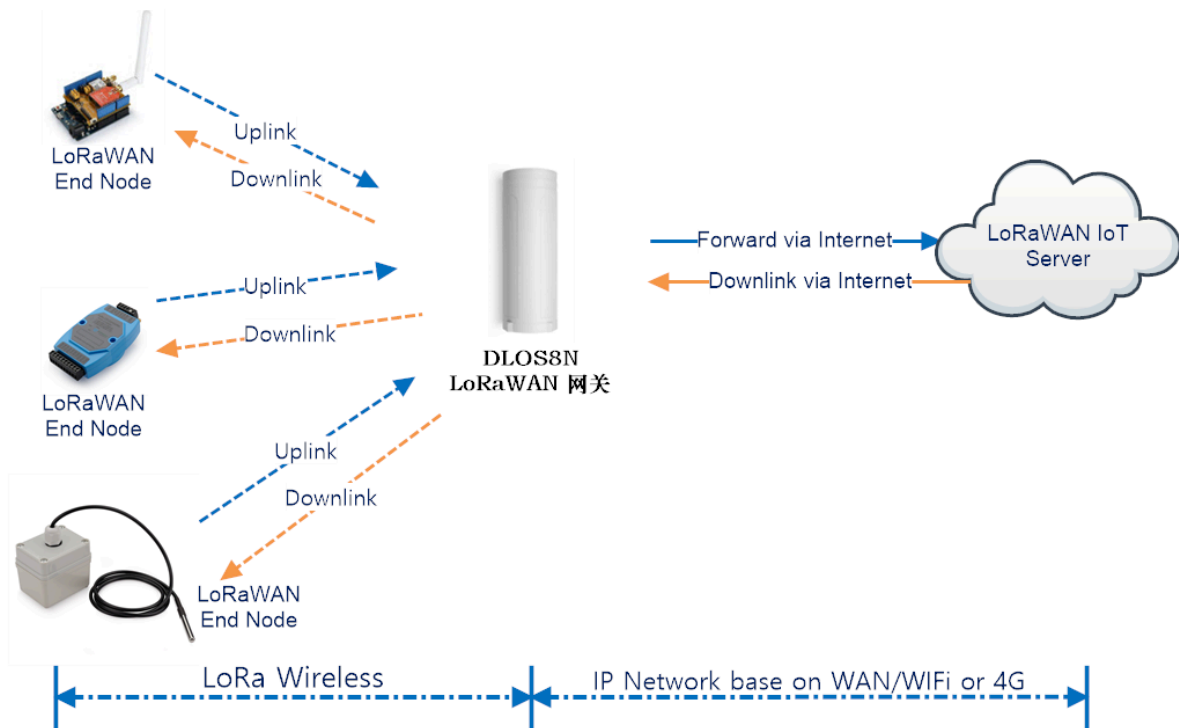

This chapter describes how to use the DLOS8N to work with

The Things Network v3 (TTN v3) [LoRaWAN Server](http://www.thethingsnetwork.org) (www.thethingsnetwork.org)

4.1 Create a gateway in TTN V3 Server

Step 1: Get a Unique gateway ID.

Every DLOS8N has a unique gateway ID. The ID can be found at LoRaWAN page:

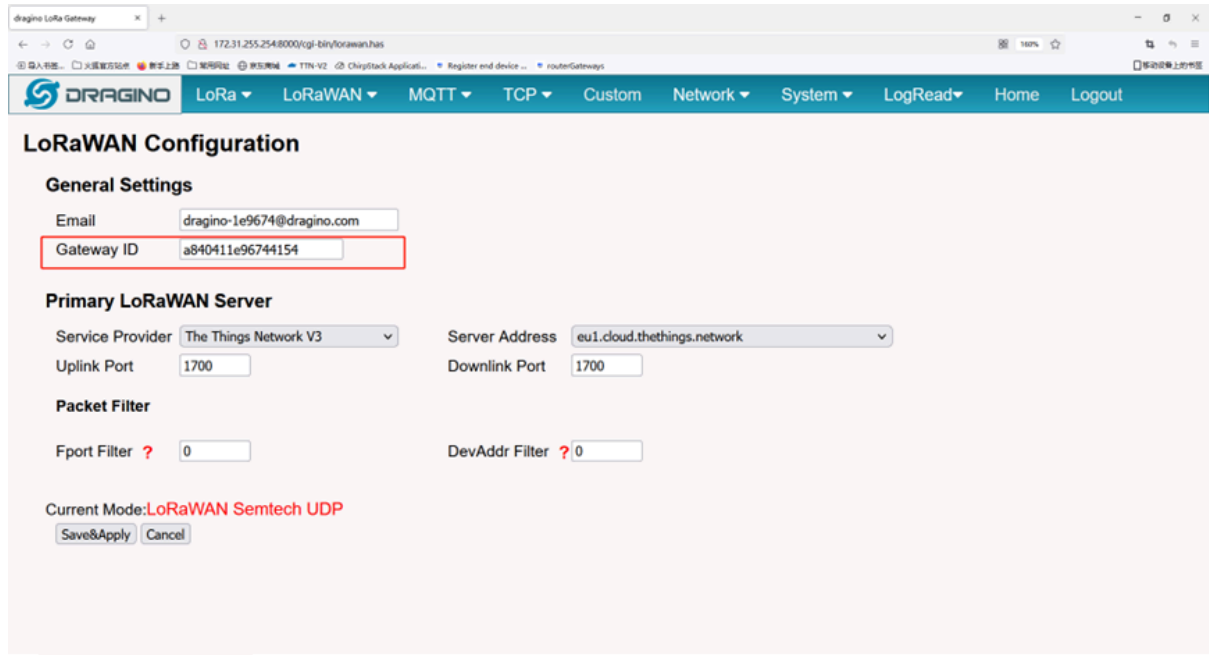

The example gateway id is: **a840411e96744154**

Step 2: Sign up a user account in TTN server

<https://account.thethingsnetwork.org/register>



Step 3: Choose the TTNv3 Cluster Picker

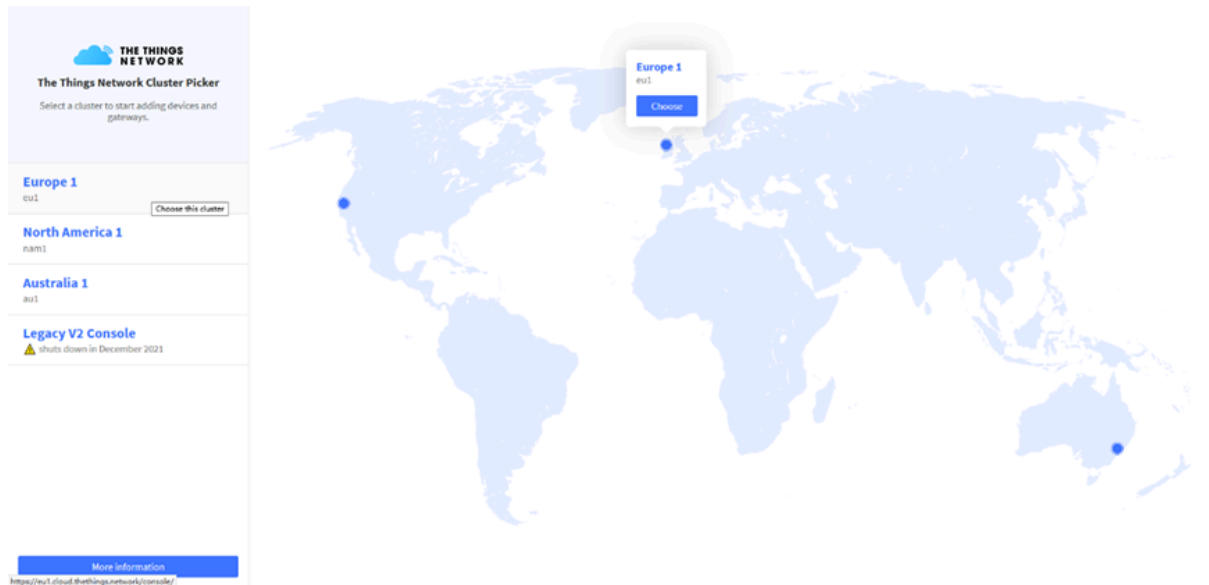

Note: Choose the cluster corresponds to a specific Gateway server address

- Europe 1 corresponding Gateway server address: eu1.cloud.thethings.network
- North America 1 corresponding Gateway server address: nam1.cloud.thethings.network
- Australia 1 corresponding Gateway server address: au1.cloud.thethings.network
- Legacy V2 Console : TTN v2 shuts down in December 2021

Step 4: Create a Gateway

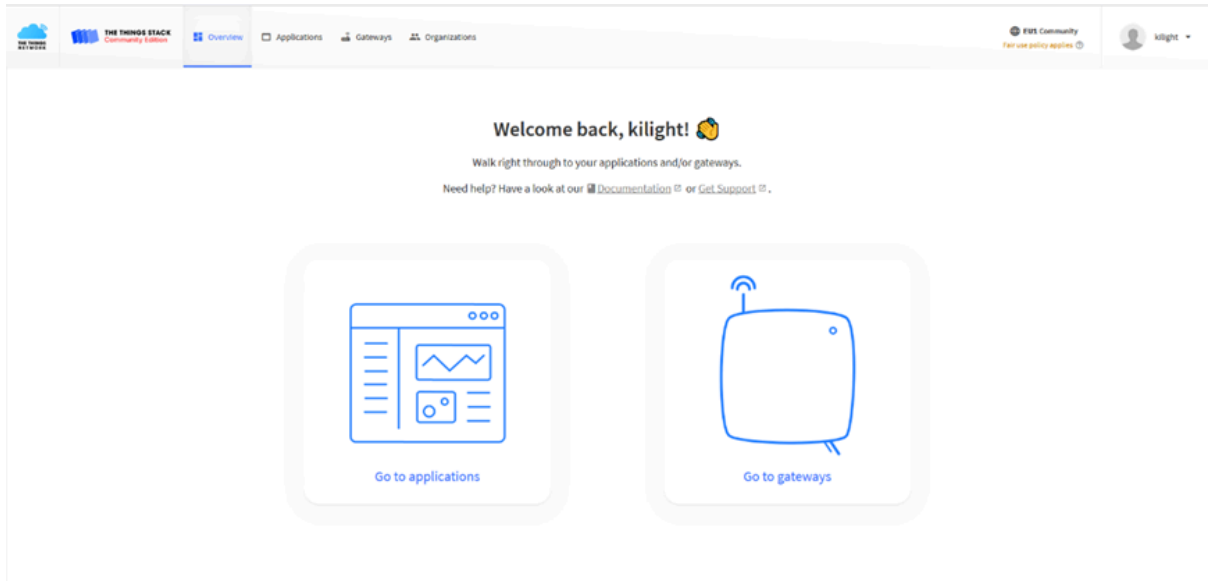

Click the Gateway icon and then click Add gateway.

Open the following page:

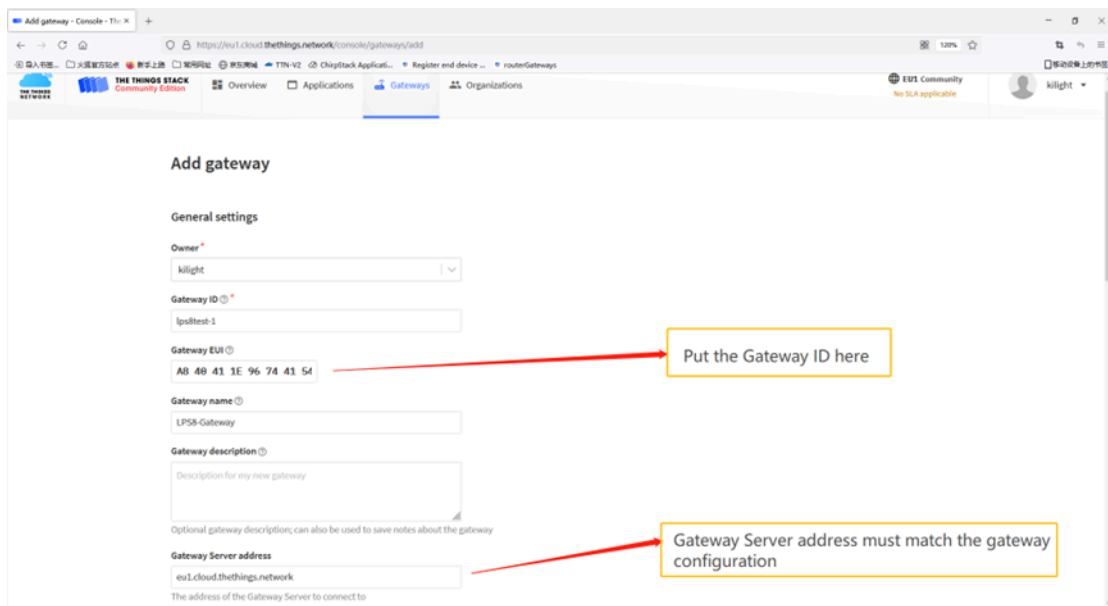

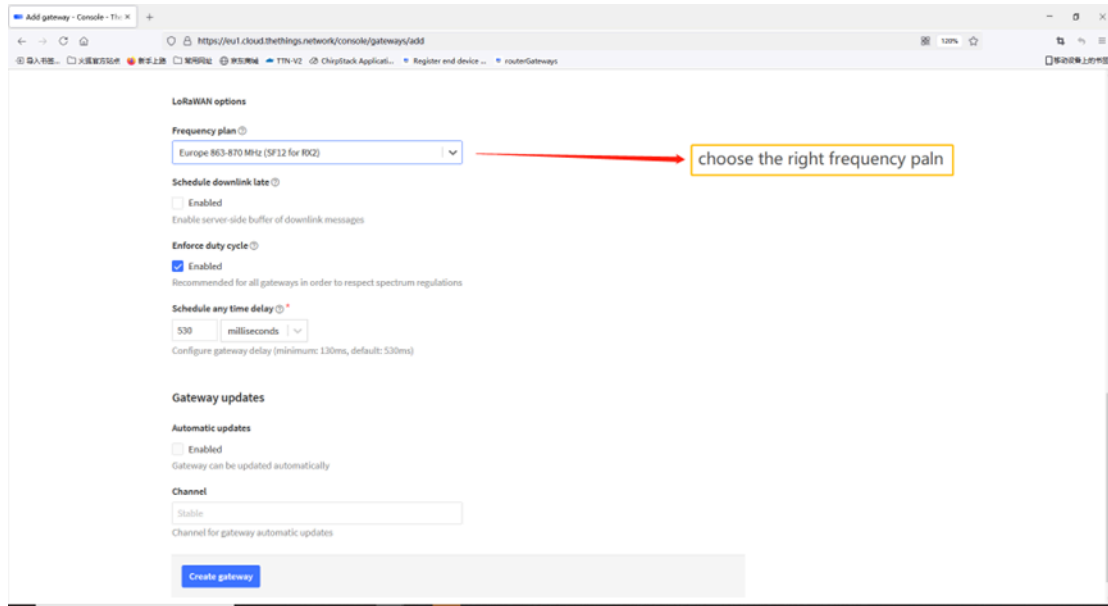

Notice: Gateway Server address must match the gateway configuration, otherwise you will have problem for End Node to join the network.

After creating the gateway, you can see the gateway info, as below.

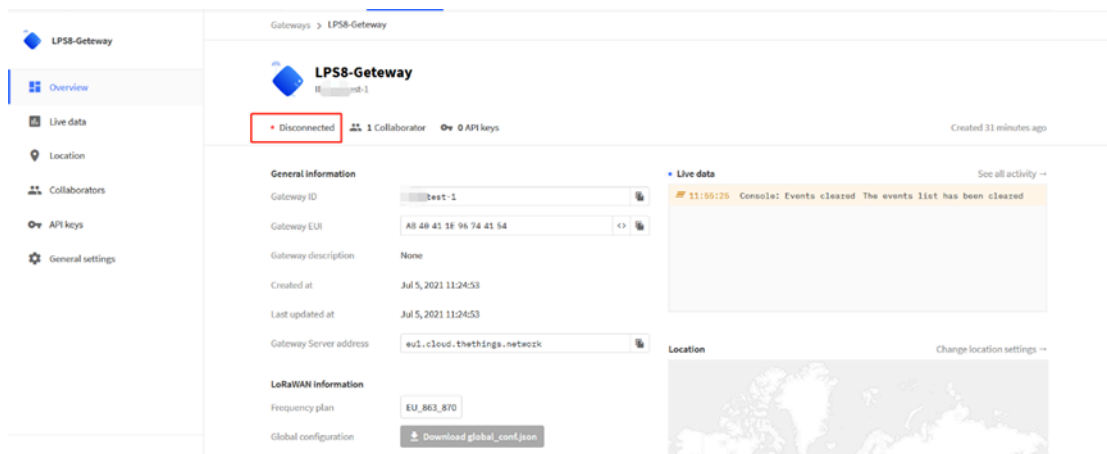

4.2 Configure DLOS8N to connect to TTN v3

You can now configure the DLOS8N to let it connect to TTN network V3.

Make sure your DLOS8N has a working Internet Connection first.

Choose the right server provider and click [Save&Apply](#)

DRAGINO LoRa LoRaWAN MQTT TCP Custom Network System LogRead Home Logout

LoRaWAN Configuration

General Settings

Email:
Gateway ID:

Primary LoRaWAN Server

Service Provider: Server Address:
Uplink Port: Downlink Port:

Packet Filter

Fport Filter ? DevAddr Filter ?

Current Mode: **LoRaWAN Semtech UDP**

Note: The server address must match the Gateway server address you choose in TTN V3.

In the home page, we can see the LoRaWAN connection is ready now.

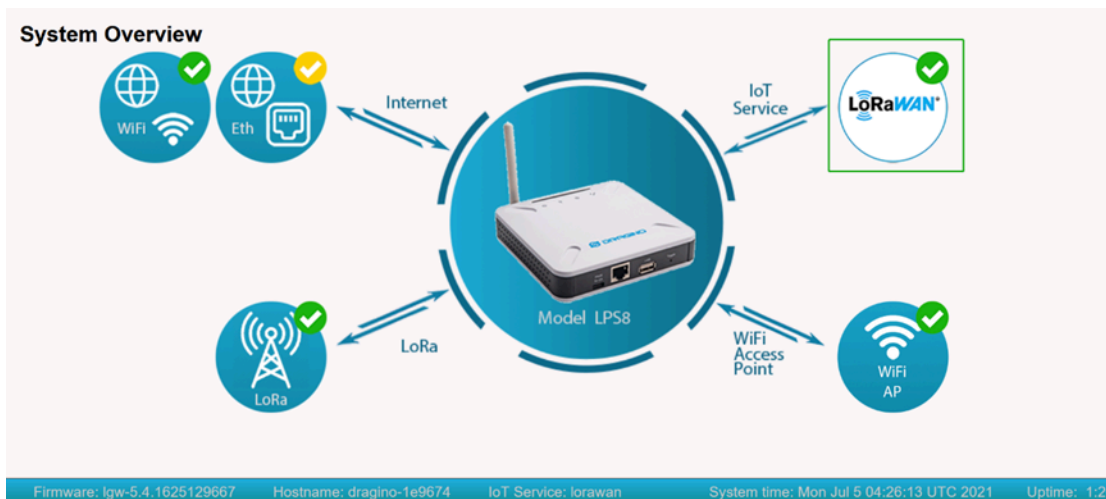

In TTN v3 portal, we can also see the gateway is connected.

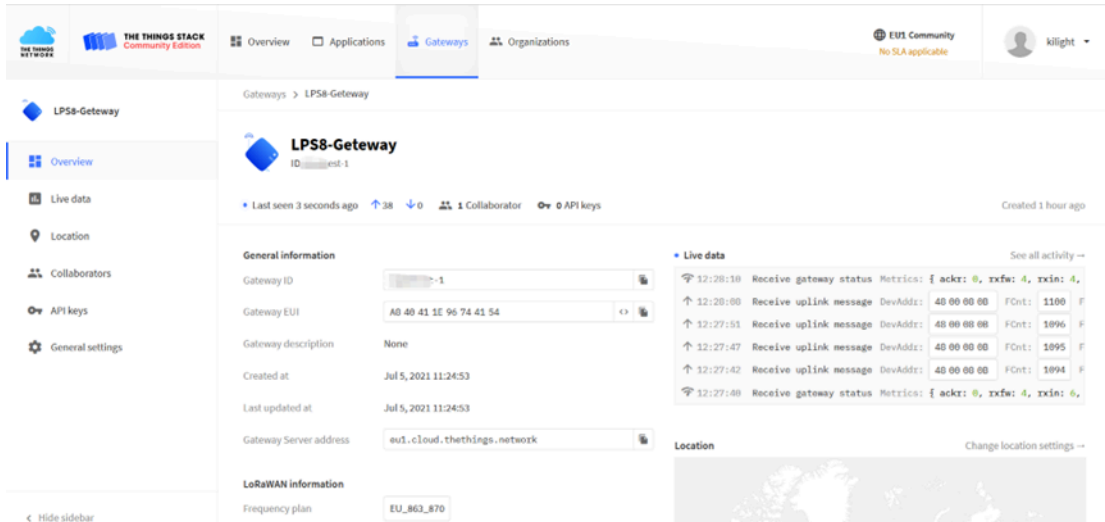

4.3 Configure frequency

We also need to set the frequency plan in DLOS8N to match the end node we use, so to receive the LoRaWAN packets from the LoRaWAN sensor.

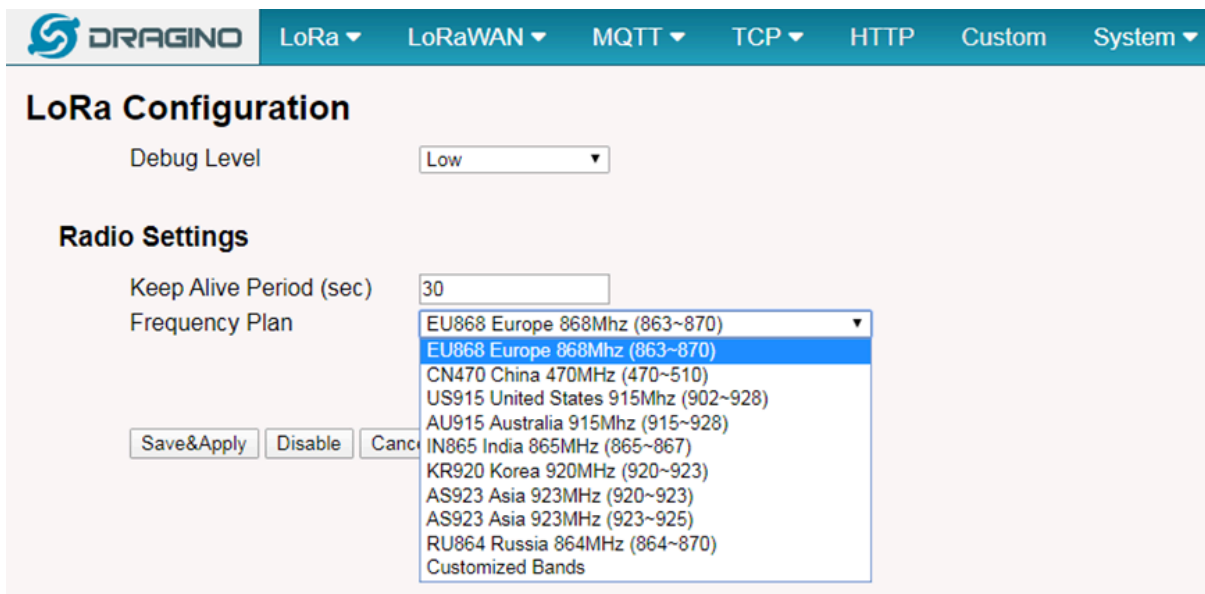

In logread page, user can check the frequency actually used.

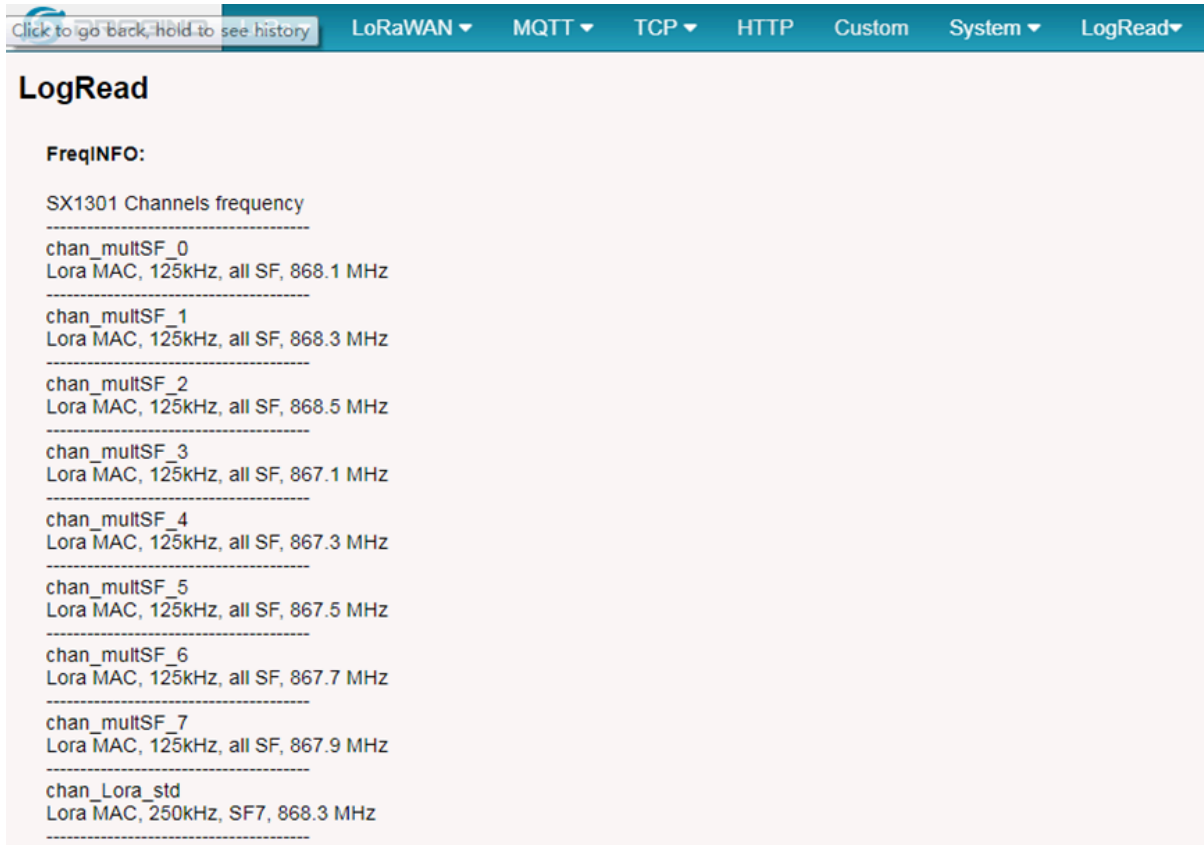

The screenshot shows a web browser interface with a navigation bar at the top containing links for LoRaWAN, MQTT, TCP, HTTP, Custom, System, and LogRead. The main content area is titled "LogRead" and displays "FreqINFO:" followed by a list of channel configurations under the heading "SX1301 Channels frequency". Each entry includes a channel identifier (e.g., chan_multSF_0) and its corresponding Lora MAC, bandwidth, and frequency.

```
SX1301 Channels frequency
-----
chan_multSF_0
Lora MAC, 125kHz, all SF, 868.1 MHz
-----
chan_multSF_1
Lora MAC, 125kHz, all SF, 868.3 MHz
-----
chan_multSF_2
Lora MAC, 125kHz, all SF, 868.5 MHz
-----
chan_multSF_3
Lora MAC, 125kHz, all SF, 867.1 MHz
-----
chan_multSF_4
Lora MAC, 125kHz, all SF, 867.3 MHz
-----
chan_multSF_5
Lora MAC, 125kHz, all SF, 867.5 MHz
-----
chan_multSF_6
Lora MAC, 125kHz, all SF, 867.7 MHz
-----
chan_multSF_7
Lora MAC, 125kHz, all SF, 867.9 MHz
-----
chan_Lora_std
Lora MAC, 250kHz, SF7, 868.3 MHz
-----
```

4.4 Add a LoRaWAN End Device

This section shows how to add a LoRaWAN End device to a LoRaWAN network and see the data from TTN web site.

We use [LT-22222-L](#) IO Controller as a reference device - the setup for other LoRaWAN devices will be similar.



Step 1: Create a Device definition in TTN v3 with the OTAA keys from the example LT-22222-L IO Controller device.

Three codes are required to define the device in TTN v3:

- DEV EUI - Unique ID code for a particular device.
- APP EUI - ID code for an Application defined in TTN v3.
- APP Key - Unique key to secure communications with a particular device.

A set of these codes are stored in each device by the manufacturer as the default codes for that particular device. Each device is shipped with a sticker with the default Device EUI as shown below.



Note: You may be able to change these codes in a device by using a configuration facility on the device e.g. the LT-22222 uses a serial port access and a series of AT commands. Changing the codes may be necessary in the case where you have to use codes assigned by a LoRa WAN server.

For the TTN v3 server, you can use the codes set in the device as in the following example.

Select **Add Application** to open the screen below.

The screenshot shows the TTN v3 web interface. The top navigation bar includes 'Overview', 'Applications', 'Gateways', and 'Organizations'. The 'Applications' tab is active. The main content area is titled 'Add application' and contains the following fields:

- Owner**: A dropdown menu with 'kilight' selected.
- Application ID**: A text input field containing 'test01'.
- Application name**: A text input field containing 'My new application'.
- Description**: A text area containing 'Description for my new application'.

Below the description field is a note: 'Optional application description; can also be used to save notes about the application'. At the bottom of the form is a blue 'Create application' button. The footer of the page contains the text: 'EurestHive uses novel to build extensive scale outdoor LoRaWAN networks - The Things Industries' and 'v3.13.2 Documentation 01'.

Open the **Application** select **Add end device**

Start Register the end device

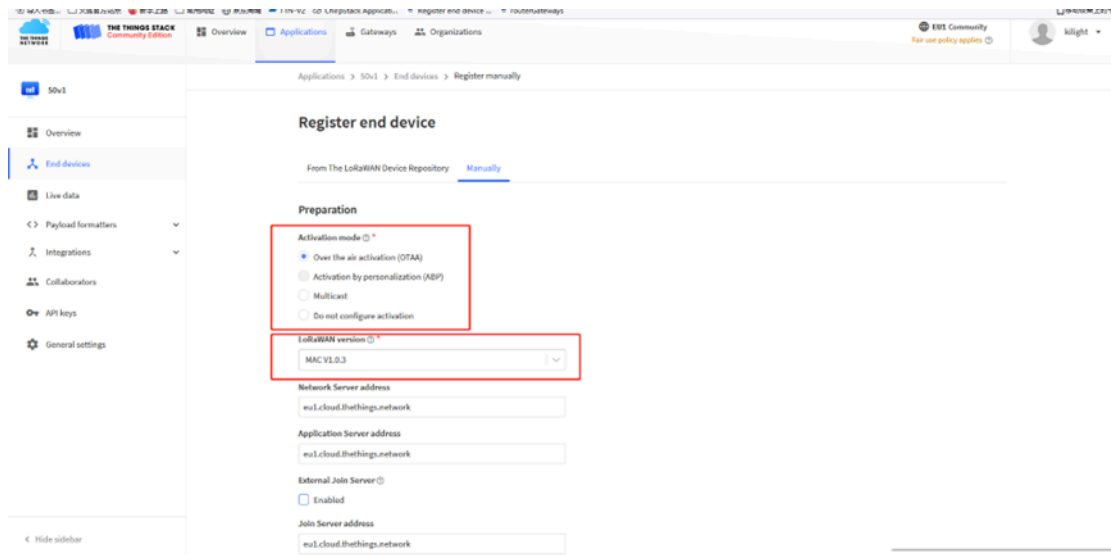

Select OTAA activation mode

The LoRaWAN version for your device should be provided by the manufacturer in a datasheet as LoRaWAN version or LoRaWAN specification. The most commonly used LoRaWAN versions are v1.0.2 and v1.0.3.

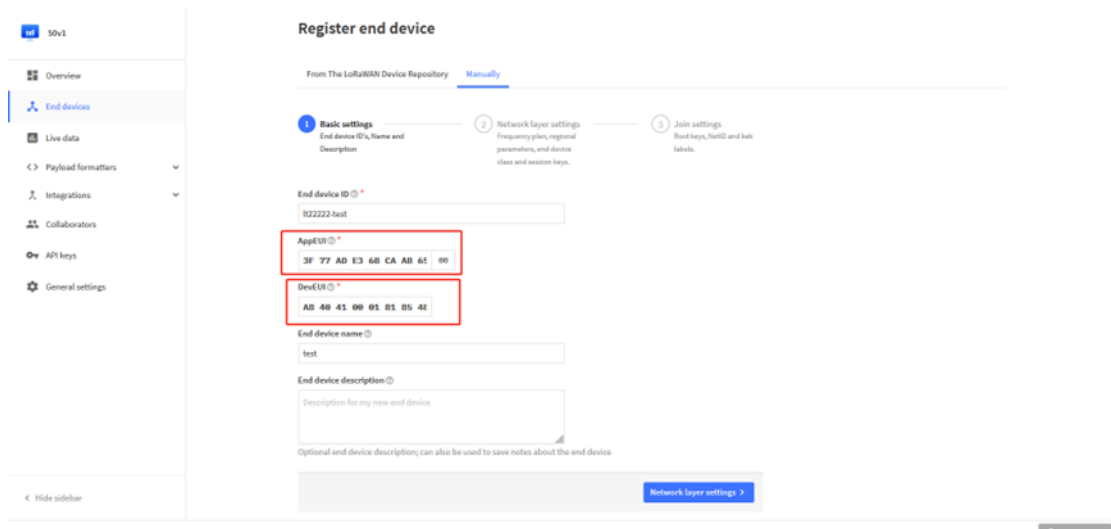

First, input the End device ID, AppEUI and DevEUI.

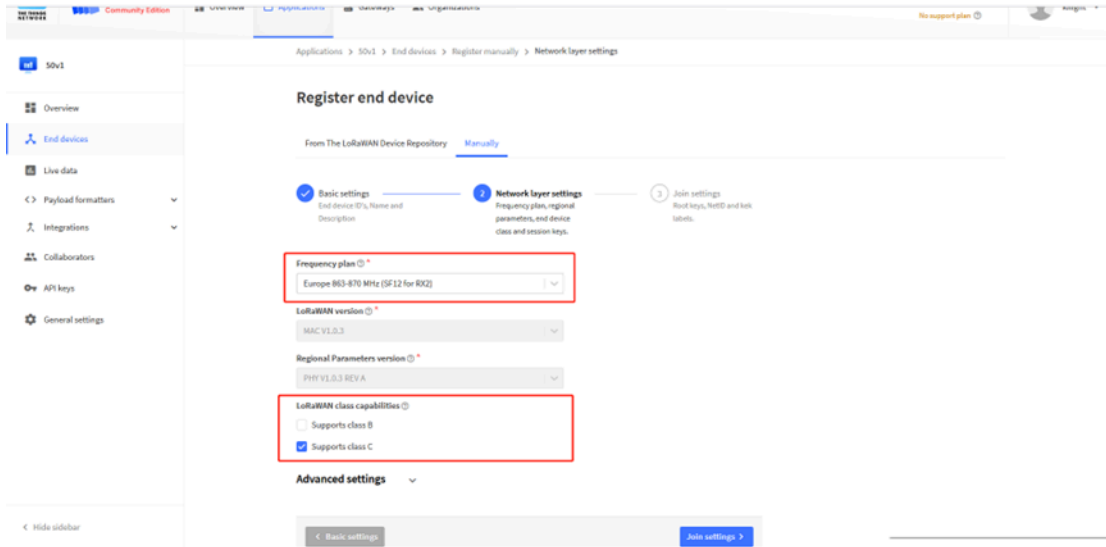

Secondly, choose the corresponding frequency and LoRaWAN class capabilities.

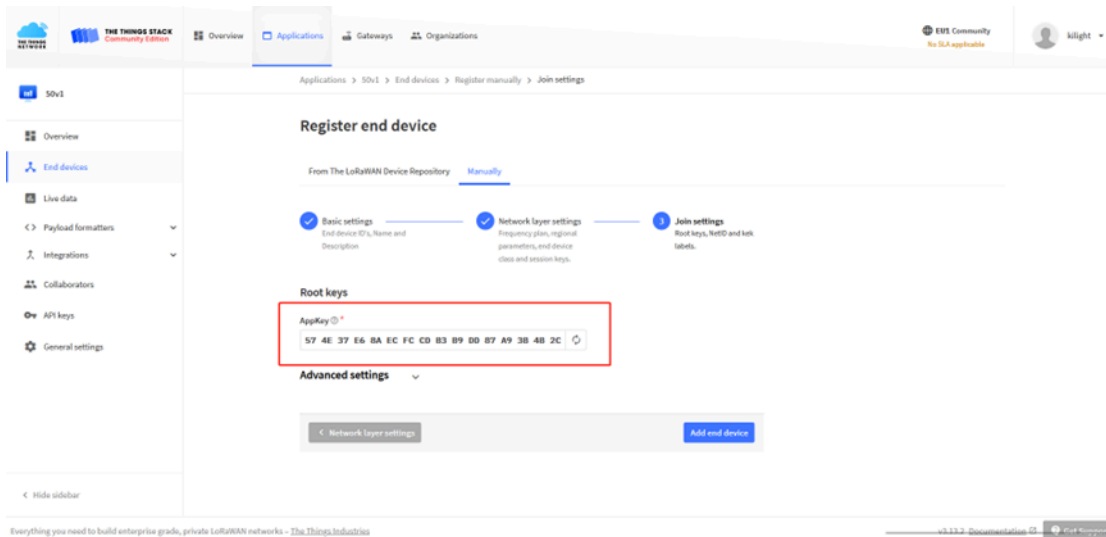

Finally, Application layer settings input the corresponding AppKey. Before saving the configuration, check that the data matches the device.

Step 2: Power on LT-22222-L device and it will automatically join the TTN network. After joining successfully, it will start to upload messages to the TTN v3. Select the Live data tab and you will see the data appearing in the panel.

Note that it may take some time for the device data to appear in the TTN v3 display.

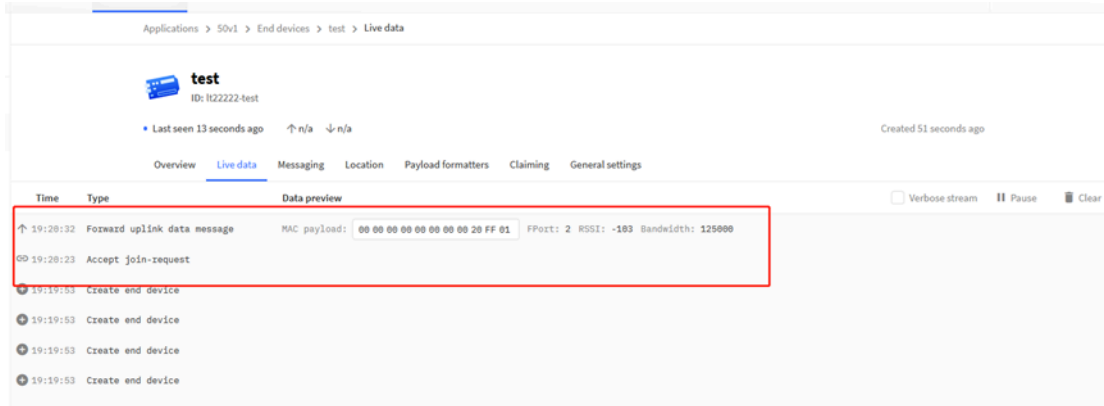

5. Web Configure Pages

5.1 Home

Shows the system running status.

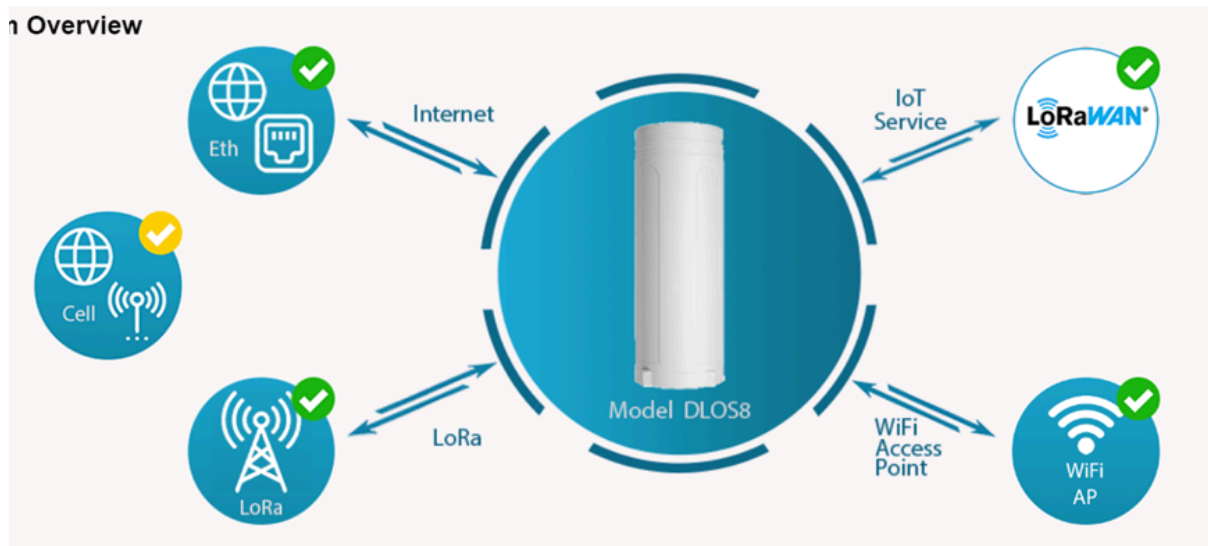

5.2 LoRa Settings

5.2.1 LoRa --> LoRa

This page shows the LoRa Radio Settings. There are a set of default frequency band according to LoRaWAN protocol, and user can customized the band* as well.

Different DLOS8N hardware version can support different frequency range:

- **868**: valid frequency: 863Mhz ~ 870Mhz. for bands EU868, RU864, IN865 or KZ865.
- **915**: valid frequency: 902Mhz ~ 928Mhz. for bands US915, AU915, AS923 or KR920

After user choose the frequency plan, he can see the actually frequency in used by checking the page **LogRead --> LoRa Log**

LoRa Configuration

Debug Level:

Radio Settings

Keep Alive Period (sec):

Frequency Plan:

- EU868 Europe 868Mhz (863~870)
- EU868 Europe 868Mhz (863~870)
- CN470 China 470MHz (470~510)**
- US915 United States 915Mhz (902~928)
- AU915 Australia 915Mhz (915~928)
- IN865 India 865MHz (865~867)
- KR920 Korea 920MHz (920~923)
- AS923 Asia 923MHz (920~923)
- AS923 Asia 923MHz (923~925)
- RU864 Russia 864MHz (864~870)
- Customized Bands

Note *: [See this instruction for how to customize frequency band](#)

5.2.2 LoRa --> ABP Decryption

The DLOS8N can communicate with LoRaWAN ABP End Node without the need of LoRaWAN server. It can be used in some cases such as:

- No internet connection.
- User wants to get data forward in gateway and forward to their server based on MQTT/HTTP, etc. (Combine ABP communication method and [MQTT forward together](#)).

Detail of this feature: [Communication with ABP End Node](#)

Decrypt ABP End Node Packets

Enable ABP Decryption

Add Key

Dev ADDR:

APP Session Key:

Network Session Key:

Delete Key Dev ADDR:

ABP Keys:

Dev ADDR | APP Session Key | Network Session Key

5.3 LoRaWAN Settings

5.3.1 LoRaWAN --> LoRaWAN

This page is for the connection set up to a general LoRaWAN Network server such as: [TTN](#), [ChirpStack](#) etc

LoRaWAN Configuration

Server Settings

LoRaWAN Service Provider	<input type="text" value="TTN-router-EU"/>		
Gateway ID	<input type="text" value="a84041ffff1d25dc"/>		
Server Port Upstream	<input type="text" value="1700"/>	Latitude	<input type="text" value="22.705177"/>
Server Port Downstream	<input type="text" value="1700"/>	Longitude	<input type="text" value="114.243423"/>

Email

Packet Filter

Eport Filter

Note:

*: User can ignore the latitude and longitude settings here, DLOS8N will use the actually value from GPS module.

**: Packet filter is to drop the unwanted LoRaWAN packet, instruction see here:

See: [Filter unwanted LoRaWAN packets](#)

5.3.2 LoRaWAN --> Amazon AWS-IoT

DRAGINO
LoRa ▾ LoRaWAN ▾ MQTT ▾ TCP ▾ Custom Network ▾ System ▾ LogRead ▾

Amazon AWS IoT -- LoRaWAN

Settings

CUPS URI	<input type="text" value="example: https://xxxxxxxx.cups.lorawan.us-east-1.amazonaws.com:443"/>		
Email	<input type="text" value="dragino-1ec39c@dragino.com"/>		
Gateway ID	<input type="text" value="a84041ffff1ec39c"/>		
CUPS trust	Not Found	<input type="button" value="選擇檔案"/> 未選擇任何檔案	<input type="button" value="Upload_CUPS_Trust"/>
Private key	Not Found	<input type="button" value="選擇檔案"/> 未選擇任何檔案	<input type="button" value="Upload_Private_key"/>
Cert pem	Not Found	<input type="button" value="選擇檔案"/> 未選擇任何檔案	<input type="button" value="Upload_Cert_pem"/>

Current Mode: **LoRaWAN Semtech UDP** Click Save & Apply will change to mode: **LoRaWAN Station for AWS**

Please see this instruction to know more detail and demo for how to connect to [AWS-IoT LoRaWAN Core](#).

5.3.3 LoRaWAN --> LORIIOT

Settings to communicate to LORIIOT LoRaWAN Network Server: <https://www.loriot.io/>

Instruction: [Notes for LORIIOT](#)

LORIoT Client Configuration

LORIoT software not installed.

Server Address: Server Port:

Client Certificate: Client Key:

CA File:

Device EUI: A840411D25DF

[Certificate Management](#)

5.4 MQTT Settings

If end nodes works in ABP mode, user can configure DLOS8N to transfer the data to MQTT broker,

Instruction: [MQTT Forward Instruction](#)

DRAGINO LoRa LoRaWAN **MQTT** TCP HTTP Custom System LogRead

MQTT Client Configuration

MQTT Server Profile:

Broker Address [-h]: Broker Port [-p]:

User ID [-u]: Password [-P]:

Certificate [--cert]: Key [--key]:

CA File [--cafile]:

Client ID [-i]:

Publish

Enable Publish Quality of Service [-q]: Topic Format [-t]:
Data Format [-m]:

Subscribe

Enable Subscribe Quality of Service [-q]: Topic Format [-t]:

5.5 System

5.5.1 System --> System Overview

Shows the system info:

System Overview

Firmware: Dragino-v2 LG02_LG08-5.4.1592278488
System: "OpenWrt 18.06-SNAPSHOT r5-ce45a50"
Hostname: dragino-1d25dc
Device Model: DLOS8
System Time: Tue Jun 16 06:24:30 UTC 2020
Uptime: 27 min
Load Avg: 0.40, 0.51, 0.43
Memory: Free Memory: 27984 / Total Memory: 60192kB
IoT Service: lorawan

Internet Connection OK



LoRaWAN Connection OK



5.5.2 System --> General (login settings)

System General

System Password

Password [Show](#) Login: root
 Password (admin) [Show](#)

TimeZone

Timezone

Port Forwarding

Enable HTTP Forward
 Enable SSH Forward

System Password:

There are two login for DLOS8N: [root /dragino](#) or [admin /dragino](#). Both root and admin has the same right for WEB access. But root user has also the right to access via SSH to Linux system. admin only able to access WEB interface.

This page can be used to set the password for them.

Timezone: Set device timezone.

Port forwarding: Enable/Disable the HTTP and SSH access via WAN interface.

5.5.3 System --> Network

Network

LAN Settings

IP Address	<input type="text" value="10.130.1.1"/>	Gateway	<input type="text" value="255.255.255.255"/>
Netmask	<input type="text" value="255.255.255.0"/>	DNS	<input type="text" value="8.8.8.8"/>

WAN Settings

Enable DHCP

WiFi WAN Settings

Enable DHCP

LAN Settings: When the DLOS8N has the AP enable, LAN settings specify the network info for DLOS8N's own network.

WAN Settings: Setting for DLOS8N WAN port

WiFi Settings: Setting for DLOS8N WiFi IP when use it as WiFi Client

5.5.4 System --> WiFi

DLOS8N WiFi Settings.

WiFi

Radio Settings

Channel (1-11)	<input type="text" value="11"/>	Tx Power (0-18) dBm	<input type="text" value="17"/>
----------------	---------------------------------	---------------------	---------------------------------

WiFi Access Point Settings

Enable WiFi Access Point

WiFi Name SSID	<input type="text" value="dragino-1d25dc"/>	Encryption	<input type="text" value="WPA2"/>
Passphrase (8-32 char)	<input type="text" value="....."/> <input type="button" value="Show"/>		

WiFi WAN Client Settings

Enable WiFi WAN Client

Host WiFi SSID	<input type="text" value="EDWIN-OFFICE"/>	WiFi Survey	<input type="text" value="Choose WiFi SSID..."/>
Passphrase	<input type="text" value="....."/> <input type="button" value="Show"/>	Encryption	<input type="text" value="WPA/WPA2"/>

5.5.5 System --> Cellular

While use the cellular as Backup WAN, device will use Cellular for internet connection while WAN port or WiFi is not valid and switch back to WAN port or WiFi after they recover.

Cellular Settings

Enable Cellular WAN
 Use Cellular as Backup WAN

APN

Service

Dial Number

Pincode

Username

Password [Show](#)

Note *: For DLOS8N which doesn't have the cellular module, this page will shows Cellular not detected.

5.5.6 System --> Network Status

System Status

Network / WiFi Status

```

Network
-----
Lan IP Address:
  inet addr:10.130.1.1 Bcast:10.130.1.255 Mask:255.255.255.0

Eth WAN IP Address:
  inet addr:10.130.2.207 Bcast:10.130.2.255 Mask:255.255.255.0
  inet addr:172.31.255.254 Bcast:172.31.255.255 Mask:255.255.255.252

WiFi WAN IP Address:
Cellular:

Bridge:
bridge name bridge id      STP enabled interfaces
br-lan      7fff.a840411d25df  no      eth0
           wlan0

WiFi
----
wlan0  ESSID: "dragino-1d25dc"
      Access Point: A8:40:41:1D:25:DC
      Mode: Master Channel: 11 (2.462 GHz)
      Tx-Power: 17 dBm Link Quality: unknown/70
      Signal: unknown Noise: -95 dBm
      Bit Rate: unknown
      Encryption: WPA2 PSK (CCMP)
      Type: nl80211 HW Mode(s): 802.11bgn
    
```

5.5.7 System --> Remote Mgmt & Auto Provision

Auto Provision is the feature for batch configure and remote management. It can be used in below two cases:

Case 1:
Batch
configure
gateways
before
deploy

Local Area Network (LAN)



http server with configure files

Case 2:
Maintain
gateway
configure
from
cloud

Internet



maintain server with configure files

How it works



1. Gateways search (on every boot or 23:00 every day) the provision URL to get configure files or script files.
2. Gateways compare version number of the configure file, and process update if configure files has higher version.



Please see this document for detail:

http://www.dragino.com/downloads/index.php?dir=LoRa_Gateway/LPS8/Firmware/Application_Note/&file=Auto-update-feature.pdf

R-SSH is for remote access device and management, introduction for how to use: [Remote Access Gateway](#)

R-SSH Host Settings

Login ID:

Host Address: Host Port:

Connect at Startup: GWID: a84041ffff1d25dc

Connection Status: **Not connected to RSSH Host**

Note: Auto connection after startup may take up to 5 minutes to clear previous connection

Generate New Keys

Current Key ID: **No keyfile present**

Caution: Generating new keys will break any existing server connections!!

[Download Public Key](#)

5.5.8 System --> Firmware Upgrade

We keep improving the DLOS8N Linux side firmware for new features and bug fixes. Below are the links for reference.

- **Latest firmware:** [LoRa Gateway Firmware](#),

(http://www.dragino.com/downloads/index.php?dir=LoRa_Gateway/LG02-OLG02/Firmware)

- **Change Log:** [Firmware Change Log](#).

(http://www.dragino.com/downloads/downloads/LoRa_Gateway/LG02-OLG02/Firmware/ChangeLog)

The file named as **xxxxx-xxxxx-squashfs-sysupgrade.bin** is the upgrade Image. There are different methods to upgrade, as below.

Web--> System--> Firmware Upgrade

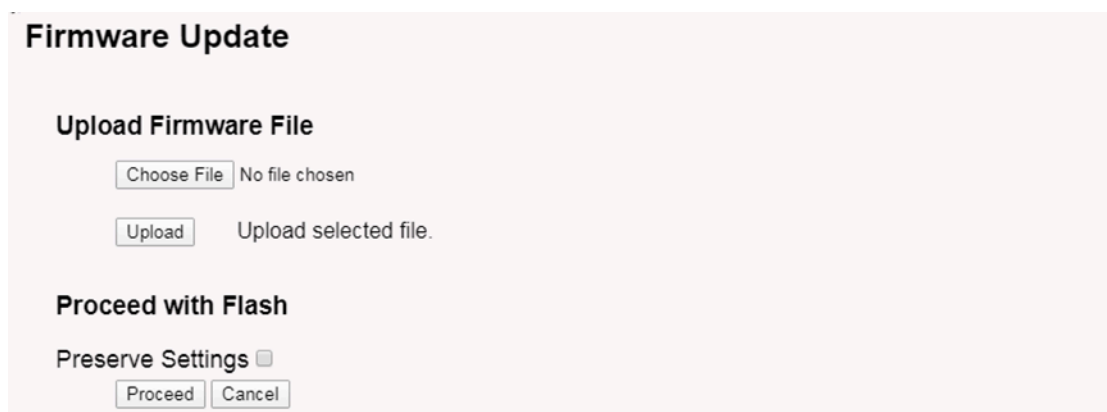

Firmware Update

Upload Firmware File

No file chosen

Upload selected file.

Proceed with Flash

Preserve Settings

Select the required image and click **Flash Image**. The image will be uploaded to the device, and then click **Process Update** to upgrade.

NOTE: You normally need to **uncheck** the **Preserve Settings** checkbox when doing an upgrade to ensure that there is no conflict between the old settings and the new firmware. The new firmware will start up with its default settings.

The system will automatically boot into the new firmware after upgrade.

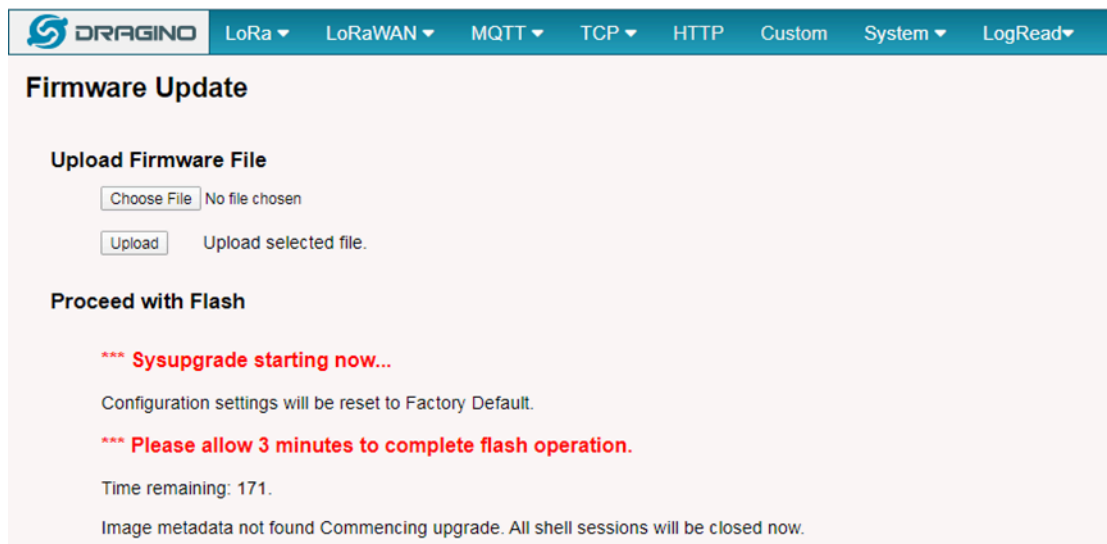

Firmware Update

Upload Firmware File

No file chosen

Upload selected file.

Proceed with Flash

***** Sysupgrade starting now...**

Configuration settings will be reset to Factory Default.

***** Please allow 3 minutes to complete flash operation.**

Time remaining: 171.

Image metadata not found Commencing upgrade. All shell sessions will be closed now.

NOTE*: User can also upgrade firmware via Linux console

SCP the firmware to the system/**var** directory and then run

```
root@OpenWrt:~# /sbin/sysupgrade -n /var/Your_Image
```

NOTE : it is important to transfer the image in the /var directory, otherwise it may exceed the available flash size.

5.5.9 System --> Reboot/Reset

Reboot / Reset

Reboot

REBOOT

Reset to Factory Default

RESET

5.5.10 System --> Package Maintain

Package Management

Package List

Package data is not loaded. Click on Reload to download package data.

Refresh Reload Click Reload to download package list. This will take a while.

Installed Package List

```
atftp - 0.7.1-5
base-files - 190-r5-ce45a50
bikid - 2.32-2
block-mount - 2018-04-16-e2436836-1
busybox - 1.28.3-4
ca-certificates - 20180409
cbat - 2.4.7-1
```



Place to show what package has installed and possible to upgrade packages.

5.6 LogRead

5.6.1 LogRead --> LoRa Log

Show the frequency for LoRa Radio and traffics.



5.6.2 LogRead --> System Log

Show the system log

System Log

USB Devices:

```
Bus 001 Device 003: ID 0403:6001 Future Technology Devices International, Ltd FT232 Serial (UART) IC
Bus 001 Device 002: ID 1a40:0101 Terminus Technology Inc. Hub
Bus 001 Device 001: ID 1d6b:0002 Linux Foundation 2.0 root hub
```

Boot Info:

```
Linux version 4.9.109 (root@DraginoHK) (gcc version 7.3.0 (OpenWrt GCC 7.3.0 r7360-e15565a) ) #0 Fri Jun 29 16:58:53 2018
MyLoader: sysp=aaaaaaaa, boardp=2aabaab, parts=aaaa2aab
bootconsole [early0] enabled
CPU0 revision is: 00019374 (MIPS 24Kc)
SoC: Atheros AR9330 rev 1
Determined physical RAM map:
memory: 04000000 @ 00000000 (usable)
Initrd not found or empty - disabling initrd
Primary instruction cache 64kB, VIPT, 4-way, linesize 32 bytes.
Primary data cache 32kB, 4-way, VIPT, cache aliases, linesize 32 bytes
```

Previous Log:

6. More features

6.1 More instructions

[LoRaWAN Gateway Instruction](#)(LoRaWAN Gateway)

7. Linux System

The DLOS8N is based on the OpenWrt Linux system. It is open source, and users are free to configure and modify the Linux settings.

7.1 SSH Access for Linux console

User can access the Linux console via the SSH protocol. Make sure your PC and the DLOS8N are connected to the same network, then use a SSH tool (such as [putty](#) in Windows) to access it.

IP address: IP address of DLOS8N

Port: 22 (via WiFi AP mode) or 2222 (via WAN Interface)

User Name: **root**

Password: **dragino** (default)

After logging in, you will be in the Linux console and can enter commands as shown below.

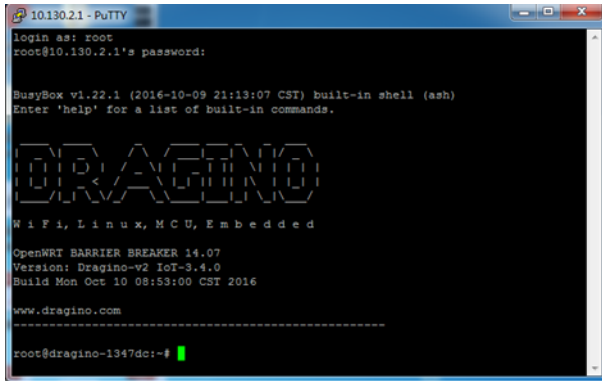

The “**logread -f**” command can be used to debug how system runs.

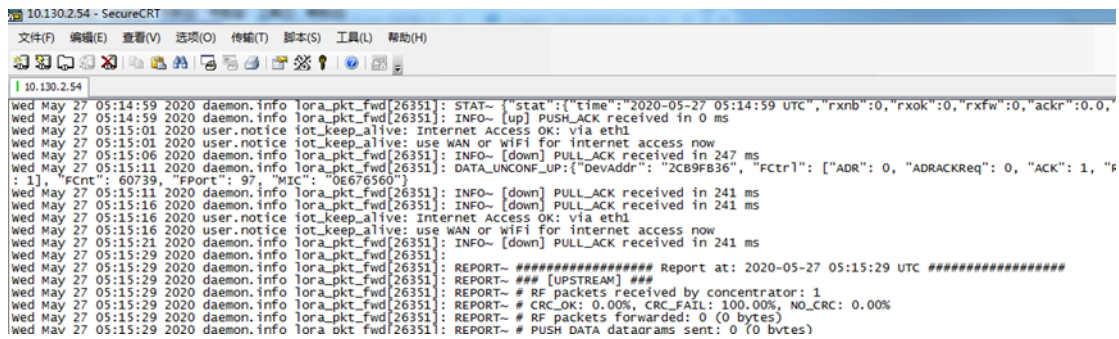

7.2 Edit and Transfer files

The DLOS8N supports the **SCP protocol** and has a built-in **SFTP server**. There are many ways to edit and transfer files using these protocols.

In Windows, one of the easiest methods is using the [WinSCP](#) utility.

After establishing access via WinSCP to the device, you can use an FTP style window to drag / drop files to the DLOS8N, or edit the files directly in the windows.

Screenshot is as below:

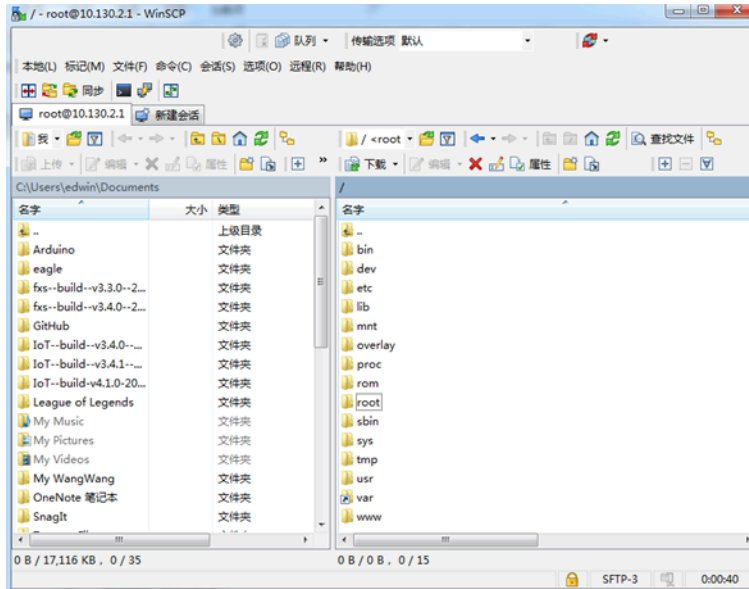

7.3 File System

The DLOS8N has a 16MB flash and a 64MB RAM. The /var and /tmp directories are in the RAM, so contents stored in /tmp and /var will be erased after rebooting the device. Other directories are in the flash and will remain after reboot.

The Linux system uses around 8MB ~10MB flash size which means there is not much room for user to store data in the DLOS8N flash.

You can use an external USB flash memory device to extend the size of flash memory for storage.

7.4 Package maintenance system

DLOS8N uses the OpenWrt [OPKG package maintenance system](#). There are more than 3000+ packages available in our package server for users to install for their applications. For example, if you want to add the *iperf* tool, you can install the related packages and configure DLOS8N to use *iperf*.

Below are some example *opkg* commands. For more information please refer to the [OPKG package maintain system](https://oldwiki.archive.openwrt.org/doc/techref/opkg) (<https://oldwiki.archive.openwrt.org/doc/techref/opkg>)

In Linux Console run:

```
root@dragino-169d30:~# opkg update // to get the latest packages list
root@dragino-169d30:~# opkg list //shows the available packages
root@dragino-169d30:~# opkg install iperf // install iperf
```

The system will automatically install the required packages as shown below.

```
root@dragino-169d30:/etc/opkg# opkg install iperf
```

```
Installing iperf (2.0.12-1) to root...
```

```
Downloading http://downloads.openwrt.org/snapshots/packages/mips\_24kc/base/iperf\_2.0.12-1\_mips\_24kc.ipk
```

```
Installing uclibcxx (0.2.4-3) to root...
```

```
Downloading http://downloads.openwrt.org/snapshots/packages/mips\_24kc/base/uclibcxx\_0.2.4-3\_mips\_24kc.ipk
```

Configuring uclibcxx.

Configuring iperf.

8. Upgrade Linux Firmware

9. FAQ

9.1 How can I configure for a customized frequency band?

See below link for how to customize frequency band: [How to customized LoRaWAN frequency band](#)

9.2 Can I connect DLOS8N to LORIOT?

Yes, the set up instruction is here: [Notes for LORIOT](#)

9.3 Can I make my own firmware for the gateway, where can I find the source code?

Yes, You can make your own firmware for the DLOS8N for branding purposes or to add customized applications.

The source code and compile instructions can be found at: https://github.com/dragino/openwrt_lede-18.06

9.4 Can I use 868Mhz version for 915Mhz bands?

It is possible but the distance will be very short, you can select US915 frequency band in 868Mhz version hardware. It will work but you will see the performance is greatly decreased because the 868Mhz version has an RF filter for band 863~870Mhz, all other frequencies will have high attenuation.

10. Trouble Shooting

10.1 I get kernel error when install new package, how to fix?

In some cases, when installing a package with **opkg**, it will generate a kernel error such as below due to a mismatch I the kernel ID:

```
root@dragino-16c538:~# opkg install kmod-dragino2-si3217x_3.10.49+0.2-1_ar71xx.ipk
```

```
Installing kmod-dragino2-si3217x (3.10.49+0.2-1) to root...
```

```
Collected errors:
```

```
* satisfy_dependencies_for: Cannot satisfy the following dependencies for kmod-dragino2-si3217x:
```

```
* kernel (= 3.10.49-1-4917516478a753314254643facdf360a) *
```

```
* opkg_install_cmd: Cannot install package kmod-dragino2-si3217x.
```

In this case, you can use the `-force-depends` option to install such package as long as the actual kernel version is the same.

```
Opkg install kmod-dragino2-si3217x_3.10.49+0.2-1_ar71xx.ipk -force-depends
```

10.2 How to recover the DLOS8N if the firmware crashes

Please follow this instruction to recover your gateway: [Recover Gateway](#)

10.3 I configured DLOS8N for WiFi access and lost its IP. What to do now?

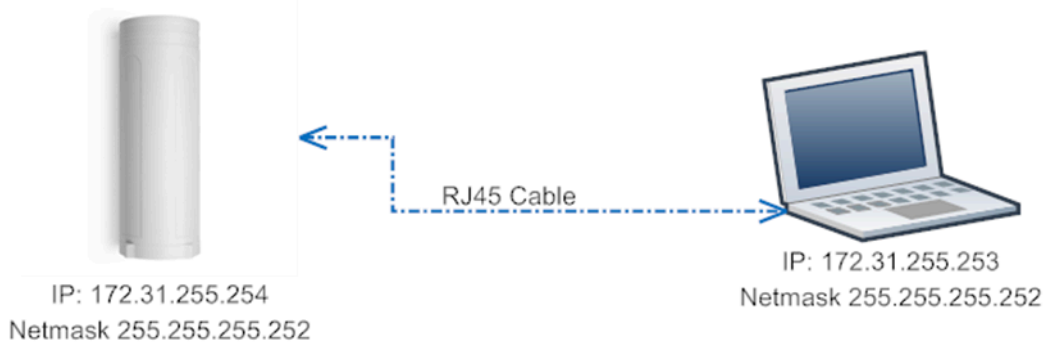

The DLOS8N has a fall-back IP address on its WAN port. This IP is always enabled so you can use the fall-back IP to access DLOS8N no matter what the WiFi IP is. The fall back IP is useful for connecting and debug the unit.

Note: fallback IP can be disabled in the WAN and DHCP page.

Steps to connect via fall back IP:

1. Connect PC's Ethernet port to DLOS8N's WAN port
2. Configure PC's Ethernet port has IP: 172.31.255.253 and Netmask: 255.255.255.252

As below photo:

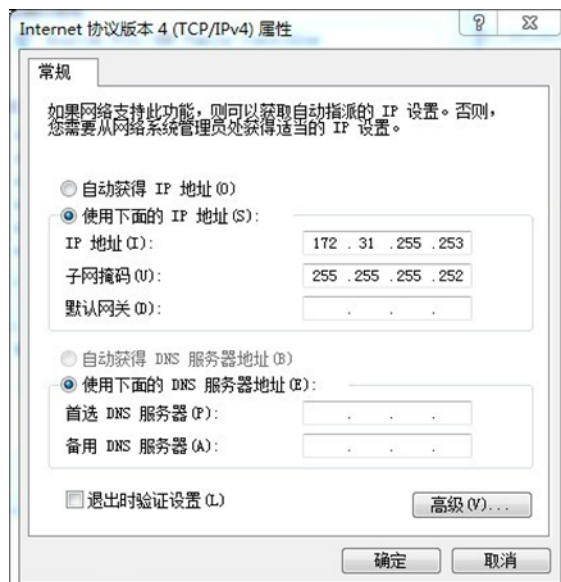

3. In the PC, use IP address 172.31.255.254 to access the DLOS8N via Web or Console.

Please note the latest firmware uses port 8000 for http and 2222 for ssh access.

11. Order Info

PART: DLOS8N-XXX-YYY:

XXX: Frequency Band

- **868** : valid frequency: 863Mhz ~ 870Mhz. for bands EU868, RU864, IN865 or KZ865.
- **915**: valid frequency: 902Mhz ~ 928Mhz. for bands US915, AU915, AS923 or KR920

YYY: 4G Cellular Option

- **E**: EMEA, Korea, Thailand, India.
- **A**: North America/ Rogers/AT&T/T-Mobile.
- **AU**: Latin America, New Zeland, Taiwan
- **J**: Japan, DOCOMO/SoftBank/ KDDI

More info about valid bands, please see [EC25-E product page](#).

12. Packing Info

Package Includes:

- DLOS8N LoRaWAN Gateway x 1
- Stick Antenna for LoRa RF part. Frequency is one of 470 or 868 or 915Mhz depends the model ordered
- Packaging with environmental protection paper box

Dimension and weight:

- Device Size: 26 x 9 x 8.5 cm
- Weight: 450g
- Package Size: 49 x 19.5 x x 19Package Size: 4912 cm
- Weight: 2.5kg

13. Support

- Try to see if your questions already answered in the [wiki](#).
- Support is provided Monday to Friday, from 09:00 to 18:00 GMT+8.
Due to different timezones we cannot offer live support. However, your questions will be answered as soon as possible in the before mentioned schedule.
- Provide as much information as possible regarding your enquiry (product models, accurately describe your problem and steps to replicate it etc) and send a mail to:support@dragino.com