

# Operating Manual

## ELT Ultrasonic



## Important safety information



Read this manual before attempting to install the device!

Failure to observe recommendations included in this manual may be dangerous or cause a violation of the law. The manufacturer, Elektroniksystem i Umeå AB will not be held responsible for any loss or damage resulting from not following the instructions of this operating manual.

- The device must not be dismantled or modified in any way.
- The device is not intended to be used as a reference sensor, and Elektroniksystem i Umeå AB will not be held liable for any damage which may result from inaccurate readings.
- The battery should be removed from the device if it is not to be used for an extended period. Otherwise, the battery might leak and damage the device. Never leave a discharged battery in the battery compartment.
- The device must never be subjected to shocks or impacts.
- To clean the device, wipe with a soft moistened cloth. Use another soft, dry cloth to wipe dry. Do not use any detergent or alcohol to clean the device.



Disposal note in accordance with ElektroG and WEEE Directive 2012/19/EU

The device, as well as all the individual parts, must not be disposed of with household waste or industrial waste. You are obliged to dispose of the device at the end of its service life in accordance with the requirements of ElektroG in order to protect the environment and to reduce waste through recycling. For additional information and how to carry out disposal, please contact the certified disposal service providers. The sensors contain a lithium battery, which must be disposed of separately.

## Contents

Important safety information .....	2
Description .....	4
Main features of ELT Ultrasonic.....	5
Installation .....	6
Sensor configuration.....	7
NFC Configuration .....	7
Over the air configuration.....	8
Application parameters .....	8
Sensor behavior.....	8
NFC Read / Write.....	8
Sensor startup.....	9
Sampling mode / Periodic measurement .....	10
Schedule Transmission .....	10
Specifications .....	11
Sensor payload format.....	11
Regulations.....	12
Legal Notices.....	12
Declaration of conformity.....	12

## Description

ELT Ultrasonic distance sensor can be placed in various environments to measure distance as well as temperature, humidity, and atmospheric pressure. It is enclosed in an IP67 box and is designed to be mounted outside. ELT Ultrasonic is the ideal sensor for measuring in advanced places or extreme weather conditions, and has the capacity of measuring with remarkably long range. This is a battery-powered device equipped with NFC (Near Field Communication) and can easily be configured from a smartphone.

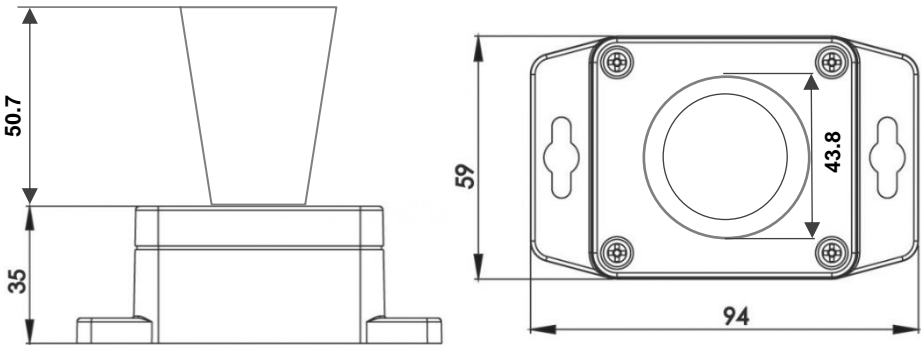

The barcode contains DevEUI and sensor type. This label is located at the back of your device,

### Elsys.se ELT -----

DevEUI: A81758FFFFExxxxxx



[elsys.se/lora](https://elsys.se/lora)

S-1933F



## Main features of ELT Ultrasonic

- Compatible with LoRaWAN® specification 1.0.3
- Measures distance of objects from 300 – 5000 mm
- Measures ambient temperature
- Measures ambient humidity
- Measures ambient atmospheric pressure
- Detects acceleration
- Easy installation
- Easy configuration
- IP67 Classified
- Battery-powered
- Long-range communication
- Configurable over NFC
- Configurable over the air
- Ten years of battery life\*
- Supported channel plans: US902-928, EU863-870, AS923, AU915-928, KR920-923, RU864, IN865 & HK923
- CE Approved and RoHS compliant

*\*Depending on settings and environmental factors*

## Installation

1. Remove the front lid of the sensor by removing the four screws.
2. Install the battery. The ELT Ultrasonic requires one AA battery. The battery type is 3.6V Lithium Battery (ER14505).

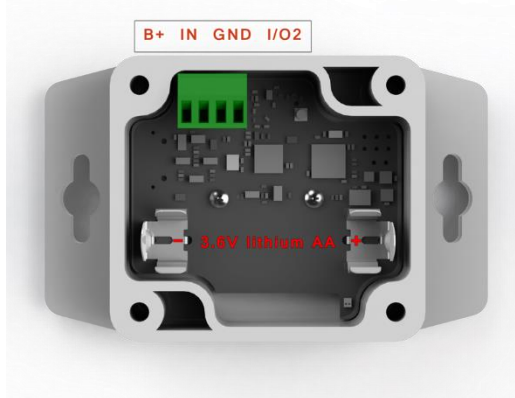

*Caution: Using batteries other than the ones provided may result in loss of performance and battery life, and also damage to the device. Dispose of properly, observing environmental protection rules.*

3. Close the lid and tighten the screws carefully. Make sure that the cable gland and antenna connection is tightened to prevent ingress of moisture.
4. Mount the device by using the two holes on the sides.

## Sensor configuration

All sensor settings can be configured via a smartphone application with NFC (Near Field Communication) or over the air via the network server and downlink data to the sensor. The sampling rate, spreading factor, encryption keys, port, and modes can be changed. All sensor settings can be locked from the server or NFC to make end-users unable to read or change settings on the sensor.

### NFC Configuration

1. Download ELSYS "Sensor Settings" application from Google Play or App Store (from iOS 13) and install it on a smartphone or tablet. The device must support NFC.
2. Enable NFC on the device and start the application.
3. Place your device on top of the NFC antenna on the sensor.

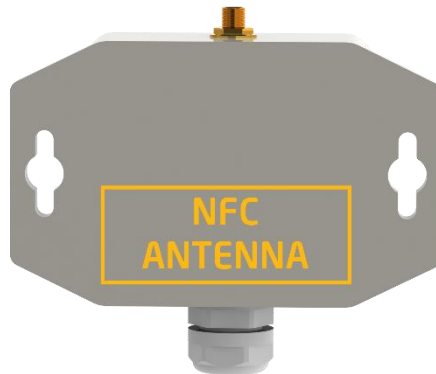

4. Remove the device. Current settings will be displayed in the application.
5. Choose "Distance sensor Maxbotix" under External Configuration.
6. Use the application to change any settings if needed.
7. Quickly tap the device on top of the NFC antenna to give the new settings to the sensor. Make sure that the application confirms your new settings.
8. Wait for the sensor to reboot (5 sec), indicated by the LED flashing. Sensor settings have been updated.

See the section "Help" in the application for more information.

## Over the air configuration

All settings may be configured over the air via your LoRaWAN® infrastructure. Please visit the support section on our webpage for more information regarding downlink protocol.

## Application parameters

All parameters for the “Sensor settings” application can be found in our settings document. Please visit the support section on our webpage for more information.

## Sensor behavior

### NFC Read / Write

1. When reading or writing NFC configuration data to the sensor, it starts a timer and delays its action 5 seconds.
2. After the delay, the sensor determines if the NFC data has changed or not. If the data has changed, the sensor reboots and starts from power-up.
3. Write your settings in the application and then locate the NFC antenna of the phone and sensor. Keep the two devices close and do not move them to get the best connectivity as possible when writing or reading data to the sensor. Bad connection can be caused by long distance, wrong location, or rapid movement.
4. When you have written data to the sensor, let the sensor reboot and restart before trying to write again.

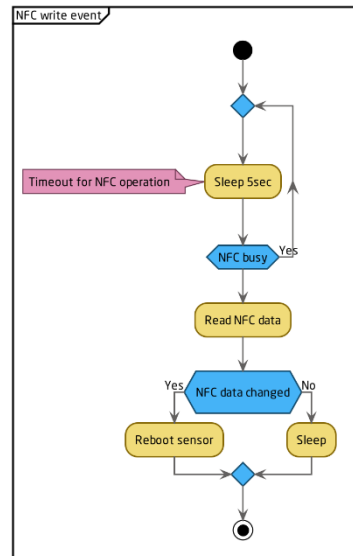

You should always validate your settings by reading the NFC data after the sensor has restarted.



## Sensor startup

1. When the sensor starts up, it loads configuration from the internal memory and merges it with user configuration.
2. When the configuration is done, the sensor writes the new configuration to the NFC chip. The sensor always writes new configurations to the NFC chip when something changes in the sensor or if NFC data is corrupted by an NFC writer or phone. The sensor always writes the new configuration to NFC chip at startup.
3. When the configuration is done, the sensor tries to join the network if OTAA (Over the Air Activation) is enabled.
4. The sensor LED flashes orange when it tries to join a network. It will try to join every 10 seconds initially. This interval will increase to save battery, at most up to one time per hour.
5. After successful connection to a network, the sensor sends a settings packet and enters sampling mode.

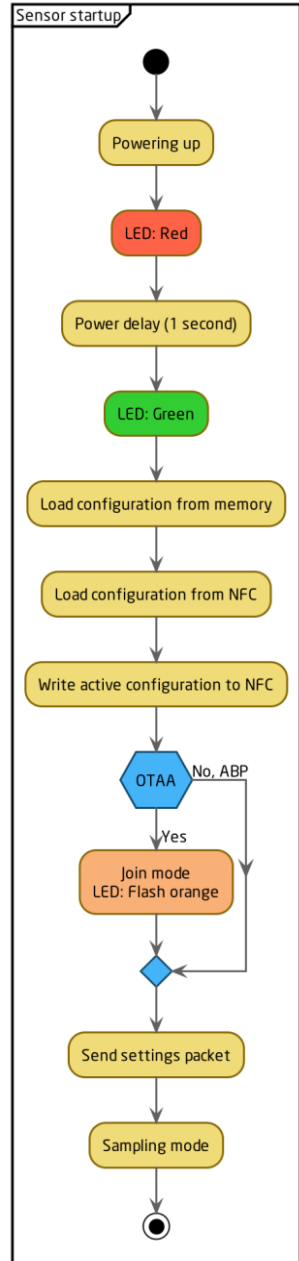

### Sampling mode / Periodic measurement

The sensor makes periodic measurements according to the user configurations.

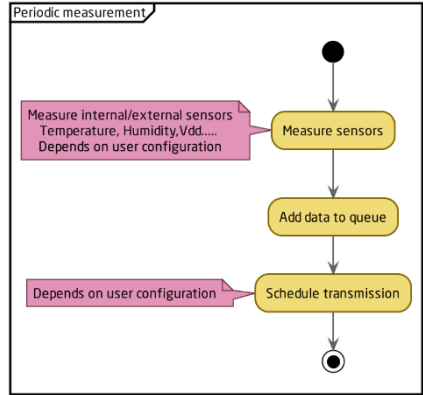

### Schedule Transmission

The sensor transmits the data according to the user configurations.

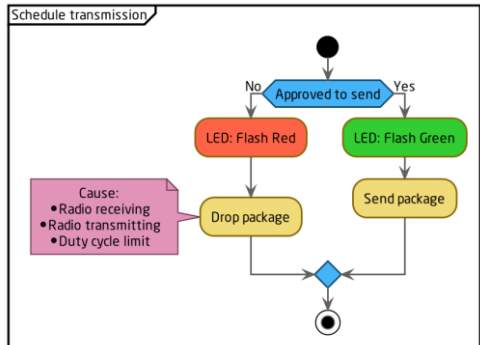

## Specifications

### Sensor payload format

The device uses the standard ELSYS payload format. Please see the specified document on our webpage.

Power supply	3.6V DC
Battery type	AA 14505 (Li-SOCl <sub>2</sub> )
EU directives compliance	RoHS 2011/65/EU WEEE 2012/19/EU
Radio protocol	LoRaWAN®
Radio frequency band	US902-928, EU863-870, AS923, AU915-928, KR920-923, RU864, IN865 & HK923
Range	8 km*
Operating conditions	-40 °C – 60 °C -40 °C – 85 °C (External power supply) 0 – 100 % RH 260 – 1260 hPa
Distance range	300 – 5000 mm Targets closer than 300 mm will typically range as 300 mm.
Temperature range	-40 – 125 °C
Temperature resolution	0.05 °C
Temperature accuracy	± 0.3 °C
Humidity range	0 – 100 %
Humidity resolution	0.05 % RH
Humidity accuracy	± 2 % RH
Pressure accuracy	± 1 hPa
Pressure range	260 – 1260 hPa
Dimensions	94 x 59 x 85.7 mm
Battery life	Up to 10 years**

*\*Measured with settings: SF10, 868 Mhz. The range can be greater or less, depending on terrain and building structure.*

*\*\*Depending on settings and environmental factors.*

## Regulations

### Legal Notices

All information, including, but not limited to, information regarding the features, functionality, and/or other product specification, are subject to change without notice. Elektroniksystem i Umeå AB reserves all rights to revise or update its products, software, or documentation without any obligation to notify any individual or entity. ELSYS and ELSYS logo are trademarks of Elektroniksystem i Umeå AB. All other brands and product names referred to herein are trademarks of their respective holders.

### Declaration of conformity

Hereby, Elektroniksystem i Umeå AB declares that ELT Ultrasonic HP complies with the essential requirements and other relevant provisions of Directive 1999/5/EC.