

Operating manual

ERS Display Series

ETHd10
EIAQd10
ETHdb10
ETHdp10
EIAQdp10
ESdp10
EVdp10
EIAQSdp10

**Address**

Twistevägen 48
90736 Umeå
Sweden

**Webpage**

www.elsys.se
www.elsys.se/shop

**E-mail**

support@elsys.se

Important Safety Information



Read this manual before attempting to install the device.

Failure to observe recommendations included in this manual may be dangerous or cause a violation of the law. The manufacturer, ElektronikSystem i Umeå AB, will not be held responsible for any loss or damage resulting from not following the instructions of this operating manual.

- The device must not be dismantled or modified in any way.
- The device is only intended for indoor use. Do not expose it to moisture.
- The device is not intended to be used as a reference sensor, and ElektronikSystem i Umeå AB will not be held liable for any damage which may result from inaccurate readings.
- The battery should be removed from the device if it is not to be used for an extended period. Otherwise, the battery might leak and damage the device. Never leave a discharged battery in the battery compartment.
- The device must never be subjected to shocks or impacts.
- To clean the device, wipe with a soft moistened cloth. Use another soft, dry cloth to wipe dry. Do not use any detergent or alcohol to clean the device.



Disposal note in accordance with Waste from Electrical and Electronic Equipment (WEEE) Directive 2012/19/EU

The device, as well as all the individual parts, must not be disposed of with household waste or industrial waste. You are obliged to dispose of the device at the end of its service life in accordance with the requirements of Directive 2012/19/EU to protect the environment and to reduce waste through recycling. For additional information and how to carry out disposal, please contact the certified disposal service providers. The sensors contain a lithium battery, which must be disposed of separately.

Table of Contents

1	Product Information	4
	1.1 Description	4
	1.2 Display Series Attributes	4
	1.3 Label	4
	1.4 Dimensions	5
	1.5 Main features of the Display Series	6
2	Mounting Guidelines	7
	2.1 Motion PIR	7
	2.2 Sound Level	7
3	Installation	8
	3.1 Installation	8
	3.2 Service and Maintenance	9
4	Sensor Configuration	10
	4.1 NFC Configuration	10
	4.2 Over the Air Configuration	10
	4.3 Application Parameters	10
5	Display	11
	5.1 Display	11
	5.2 Onscreen sensor data	12
	5.2.1 ETHd10, ETHdp10, ETHdb10	12
	5.2.2 EIAQd10, EIAQdp10	12
	5.2.3 ESdp10	12
	5.2.4 EVdp10	12
	5.2.5 EIAQSdp10	12
6	Sensor Behavior	13
	6.1 Sensor Startup	13
	6.2 Sampling mode / Periodic measurement	13
	6.3 Scheduled Transmission	13
	6.4 LED Indication	13
7	Internal Sensors	14
	7.1 Temperature Sensor	14
	7.2 Humidity Sensor	14
	7.3 Light Sensor	15
	7.4 CO ₂ Sensor	15
	7.5 VOC Sensor	15
	7.6 Motion PIR Sensor	16
	7.6.1 PIR Lens Detection Pattern	16
	7.7 Sound Level Sensor	17
	7.8 Button	17
8	Technical Information	18
	8.1 Specifications	18
	8.2 Sensor Payload Format	19
9	Regulations	20
	9.1 Legal Notices	20
	9.2 Federal Communication Commission Interference Statement	20
	9.3 Declaration of Conformity	21
10	Revision History	22

1 Product Information

1.1 Description

The ERS Display series of sensors are universal LoRaWAN® indoor climate sensors with a 2.1” E-paper display showing real-time sensor data. Depending on the model, the sensor measures temperature, humidity, light intensity, CO2 level, VOC level, and sound level and detects motion. The ERS Display series are battery-powered devices and are designed to be wall-mounted. The sensors are equipped with NFC (Near Field Communication) for easy configuration with an NFC-enabled smartphone.

1.2 ERS Display Series Attributes



Attribute

Attribute	ETHd10	EIAQd10	ETHdb10	ETHdp10	EIAQdp10	ESdp10	EVdp10	EIAQSdp10
2.13" Display	✓	✓	✓	✓	✓	✓	✓	✓
Temperature	✓	✓	✓	✓	✓	✓	✓	✓
Humidity	✓	✓	✓	✓	✓	✓	✓	✓
Light			✓	✓	✓	✓	✓	✓
Motion PIR				✓	✓	✓	✓	✓
CO ₂		✓			✓			✓
Sound level						✓		✓
VOC							✓	
Button			✓					
NFC	✓	✓	✓	✓	✓	✓	✓	✓

1.3 Label

The barcode is of type Aztec and contains DevEUI and sensor type.

This label is located at the back of your device.

1 Product Information

1.4 Dimensions

Measurements are given in millimeters.

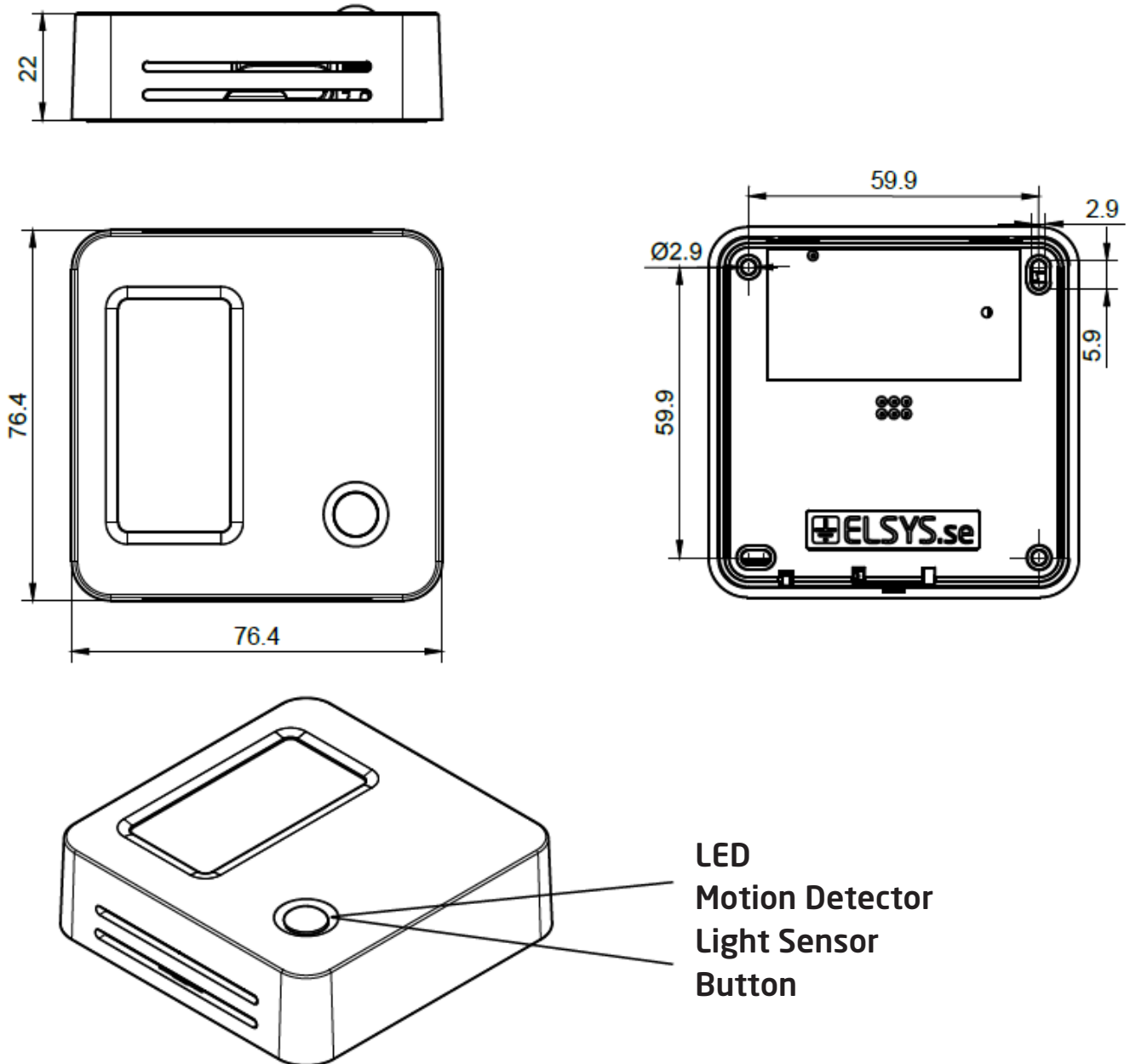

1 Product Information

1.5 Main features of the ERS Display Series

- Compatible with LoRaWAN® specification 1.0.4
- Presents real-time data on a 2.1" e-paper display
- Measures ambient temperature
- Measures ambient humidity
- Measures light intensity¹
- Measures CO₂-level¹
- Measures VOC level¹
- Measures sound-level¹
- Detects motion using a passive IR sensor¹
- Indicates high or low values with an LED light¹
- Easy installation
- Easy configuration
- May be installed on a wall or any (non-metallic) surface
- Battery-powered
- Long-range communication
- Configurable over NFC
- Configurable over the air
- Ten years of battery life²
- Supported channel plans: EU868, IN865, US915, AU915, AS923, HK923, KR923
- CE Approved and RoHS compliant

¹ Depending on model

² Depending on settings and environmental factors

2 Mounting Guidelines

Common mounting guidelines for ERS Display Series line of sensors:

- Place the sensor in an open space on the wall, with an installation height of 1.6 meters.
- For best RF and measurement performance, make sure you mount the sensor with the ventilation openings vertically. See installation in chapter 3.
- Make sure that the sensor is not placed in direct sunlight, close to heating vents, near windows, air ventilation where it may measure values that is not representative for the rest of the room.

2.1 Motion PIR

The PIR can self-trigger if sensors are placed too close to each other. Keep this in mind when you mount or test the sensors.

2.2 Sound Level

Think carefully about the placement of the sound sensor. If the sensor is placed close to loud sources such as machines or ventilation, it will be reflected in the sensor readings due to sounds being louder close to the source.

3 Installation

3.1 Installation

1. Remove the back panel of the sensor by gently prying the tab with a small screwdriver. Take care not to damage any internal components.

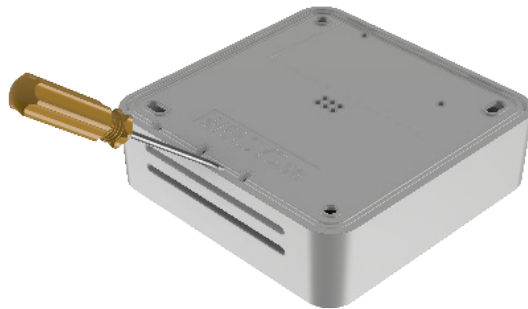

2. Install the batteries. The ERS2 requires one or two AA batteries. The battery type is 3.6V Lithium Battery (ER14505). You can use one battery, but it's recommended that you use two for best performance and battery life. Use battery slot A if only one battery is used.

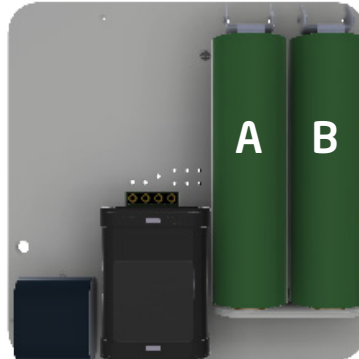

3. Mount the back panel securely to the wall with at least 2 appropriate screws, using some of the four mounting holes. Alternatively, attach the sensor with double sided adhesive tape.



3 Installation

4. Attach the sensor part by hinging it on the back panel.



3.2 Service and Maintenance

There are no serviceable parts inside. If service is needed other than battery replacement, please get in touch with your distributor.

4 Sensor Configuration

All sensor settings can be configured via a smartphone application with NFC (Near Field Communication) or over the air via the network server and downlink data to the sensor. The sampling rate, spreading factor, encryption keys, port, and modes can be changed. All sensor settings can be locked from the server or NFC to make endusers unable to read or change settings on the sensor.

4.1 NFC Configuration

1. Download ELSYS “Sensor Settings” application from Google Play or App Store and install it on a smart phone or tablet. The device must support NFC.
2. Enable NFC on the device and start the application.
3. Place your device on top of the EMS sensor to connect with the NFC antenna. Keep the two devices close to each other and don’t move them to get as good connectivity as possible. You may need to remove the top cover and battery to get connection.
4. Current settings will be displayed in the application.
5. Use the application to change any settings if needed.
6. Tap the device on top of the NFC antenna to send the new settings to the sensor. Make sure that the application confirms your new settings.
7. Wait for the sensor to reboot (1-5 sec), indicated by the LED flashing. Sensor settings have been updated. Always validate your settings by reading the NFC data after the sensor has restarted.

See the section “Help” in the application for more information.



4.2 Over the Air Configuration

All settings may be configured over the air via your LoRaWAN® infrastructure. Please visit the support section on our webpage for more information regarding downlink protocol.

4.3 Application Parameters

All parameters for the “Sensor settings” application can be found in our settings document. Please visit the support section on our webpage for more information.

5 Display

5.1 Display

The ERS Display series sensors have a 2.13" E-paper display, which keeps the onscreen information even if the sensor is unpowered.

The display will have four different modes depending on the current state of the sensor.

Factory mode: If the sensor is not yet started. See figure 1.

Join mode: When the sensor is trying to join the network. See figure 2.

Standard mode: During normal operation, the layout and values presented on the screen will depend on the sensor model and configuration. See figure 3, 4 and 5.

Low Battery mode: If the sensor detects that the battery voltage is getting close to the limit of operation, the sensor will set the screen to display information that the battery needs to be replaced. It will not recover from this mode until the batteries are replaced. See figure 6.

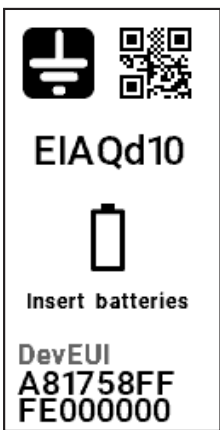

Figure 1.



Figure 2.

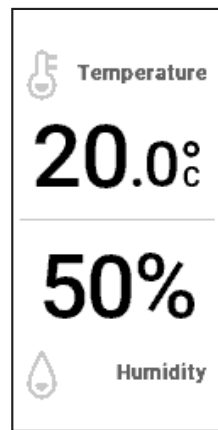

Figure 3.
Temperature and humidity.

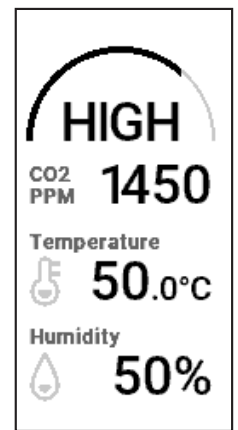

Figure 4.
CO2 level, temperature and humidity.

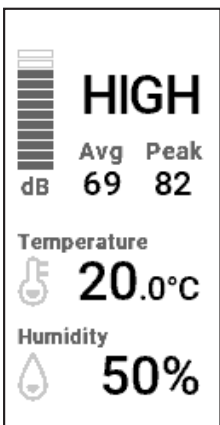

Figure 5.
Sound level, temperature and humidity

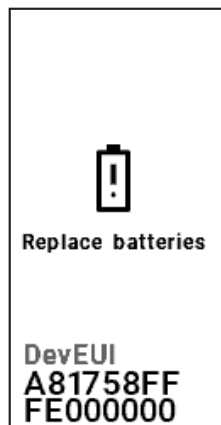

Figure 6.

The sensor will perform a full refresh of the screen every 72nd time it updates. During a full refresh, the display will flash back and forth between completely black and completely white before the new content is shown.

5 Display

5.2 Onscreen sensor data

The display is updated on a multiple of the main time base, which will be 1 by default. The onscreen values are the most recently measured as decided by the internal sensors' sample periods. The temperature unit can be configured to be shown as either Celsius or Fahrenheit. On-screen text information in standard mode can be selected by the user. Available languages are English, German, French, Italian and Spanish.

5.2.1 ETHd10, ETHdp10, ETHdb10

The ETHd10, ETHdp10 and ETHdb10 displays temperature and humidity.

5.2.2 EIAQd10, EIAQdp10

The EIAQd10 and EIAQdp10 will display temperature, relative humidity, and CO₂ levels. The numeric CO₂ levels in parts per million are displayed alongside text that will change depending on the CO₂ level and user-selectable thresholds. The text indicators are LOW, MID, and HIGH.

5.2.3 ESdp10

The Sound Level will display temperature, relative humidity, average, and peak sound levels. The numeric sound levels are displayed alongside text that will change depending on the average sound level and user-selectable thresholds. The text indicators are LOW, MID, and HIGH.

5.2.4 EVdp10

The EIAQd10 and EIAQdp10 will display temperature, relative humidity, and VOC levels. The numeric VOC levels in parts per million are displayed alongside text that will change depending on the VOC level and user-selectable thresholds. The text indicators are LOW, MID, and HIGH.

5.2.4 EIAQSdp10

The EIAQdp10 will display temperature, CO₂ levels, and sound peak and average.

The numeric CO₂ levels in parts per million are displayed alongside text that will change depending on the CO₂ level and user-selectable thresholds. The text indicators are LOW, MID, and HIGH.

6 Sensor Behavior

6.1 Sensor Startup

1. The display will be set to factory mode before the sensor is powered for the first time.
2. When the sensor starts, it loads configuration parameters stored in the NFC chip. The sensor will then write all configuration parameters back to the NFC chip.
3. When the configuration is done, the sensor tries to join the network if OTAA (Over the Air Activation) is enabled. Ensure that the sensor credentials (DevEUI, AppKey, JoinEUI) match the keys added to the server to activate the device. The join procedure starts at spreading factor 7 with a join request every ~15 seconds. The sensor will gradually increase the time and the Spreading Factor between the following join requests until the join is successful. An orange LED blink indicates every join request.
The sensor starting the join procedure will be indicated on display with the join mode screen.
4. After a successful connection to a network, the sensor sends an uplink containing the sensor settings and enters sampling mode. The screen enters its default mode of showing sensor data.

6.2 Sampling mode / Periodic measurement

The sensor makes periodic measurements according to the user configuration

6.3 Scheduled Transmission

The sensor transmits the data according to the user configuration. However, the configured sending interval can be overridden by network limitations. Due to this, the spreading factor and sending interval settings might result in longer intervals than intended.

6.4 LED Indication

LED Indicator	Action
Red/Green Sequence	Sensor is starting up
Short Orange Blink	LoRa Join Request Transmission
Short Green Blink	LoRa Uplink Transmission
Short Red Blink	Sensor failed to send an uplink. Common cause is duty cycle limits.
Long Blue Blink	Sensor has loaded new configuration from NFC

7 Internal Sensors

The populated internal sensors in the ERS Display series differ between models according to the table below.

	ETHd10	EIAQd10	ETHdb10	ETHdp10	EIAQdp10	ESdp10	EVdp10	EIAQSdp10
Temperature	●	●	●	●	●	●	●	●
Humidity	●	●	●	●	●	●	●	●
Light				●	●	●	●	●
Motion PIR				●	●	●	●	●
CO ₂		●			●			●
Sound level						●		●
VOC							●	
Button			●					

7.1 Temperature Sensor

Resolution	0.1 °C
Accuracy	0.2 °C typical, see figure 7

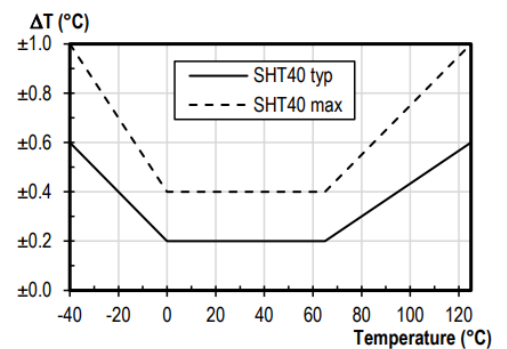

Figure 7

7.2 Humidity Sensor

Resolution	1 % RH
Accuracy at 25 °C	±2 % RH, see figure 8

For accuracy of RH over temperature, see figure 9

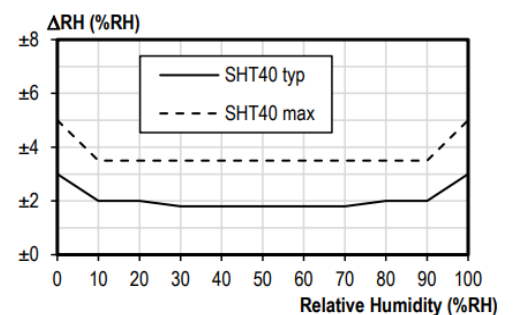

Figure 8

7 Internal Sensors

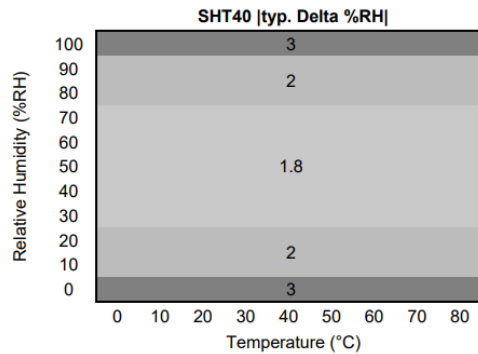

Figure 9

7.3 Light Sensor

Range	0 - 65535 lux
Accuracy	± 10 % or ± 10 lux, whichever is greater.

The light sensor sits behind the PIR lens. For correct reading, make sure it isn't obstructed. Accuracy can depend on angle of light source.

7.4 CO₂ Sensor

Range	400 - 5000 ppm
Accuracy	30 ppm, ±3 % of reading (15-35 °C, 0-80 % RH)

The CO₂ sensor normally runs an automatic baseline correction algorithm (ABC), with a period of 8 days. For a fully corrected measurement, the ABC needs 3 consecutive 8-day periods where the sensor sees fresh air sometime during each ABC period. It can also be calibrated manually, and the ABC can be turned off. In this case it is recommended to do a manual calibration in fresh air once/year.

7.5 VOC Sensor

Measurement range, Ethanol or Hydrogen in air: 0-1000000ppb*

*Conversion from ppm to mg/m³ for most common TVOC is by the factor approximately 2 (e.g., 1ppm equals approximately 2mg/m³).

7 Internal Sensors

7.6 Motion PIR Sensor

Actual range of the sensor can be influenced by environmental conditions. Avoid installing the sensor in areas where it will face direct or reflected sunlight. Avoid installing near windows, air conditioning, or heating vents. Such placements can give false values.

The PIR can cause self-trigger if sensors are placed too close to each other. Keep this in mind when you mount or test the sensors.

The PIR has a blanking time of 8 seconds right after motion event and transmission. Any movements during this time will be ignored.

7.6.1 PIR Lens Detection Pattern

Lens for Temperature & Humidity^{Pro} and Air Quality^{Pro}.

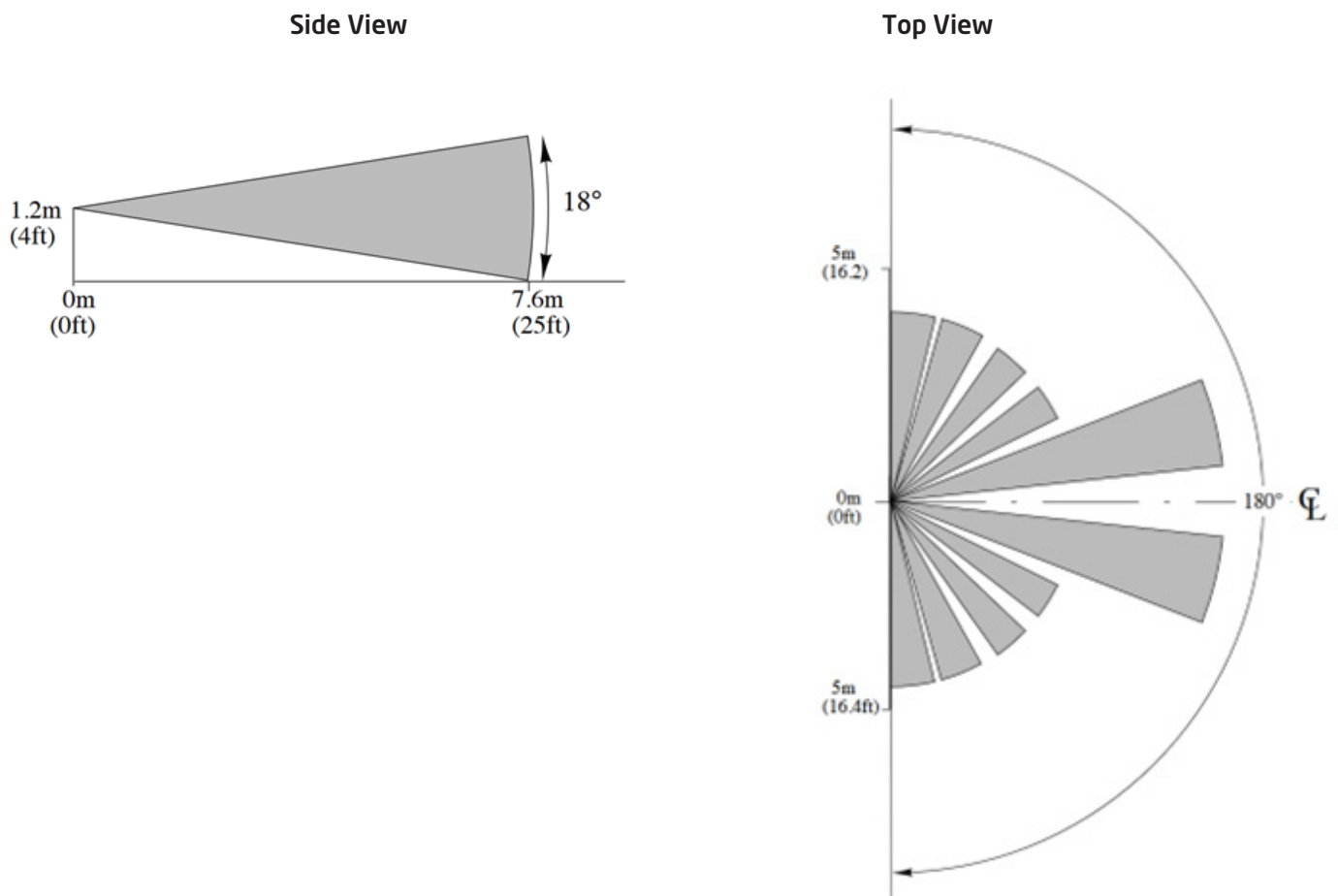

7 Internal Sensors

7.7 Sound Level Sensor

Average Value Range	32 - 75 dBspl
Peak Value Range	60 - 99 dBspl
Filtering	dBal
Sound Resolution	1 dB
Sound Accuracy	±5 dB

The sound level sensor continuously measures the average and peak sound pressure level with no missing events. The analog part is always on, with a peak-hold circuit for peak level, and a mean-value filtering for average value. The digital part wakes and samples both signals every 10 s and does the final calculation before sending the data at the desired send interval.

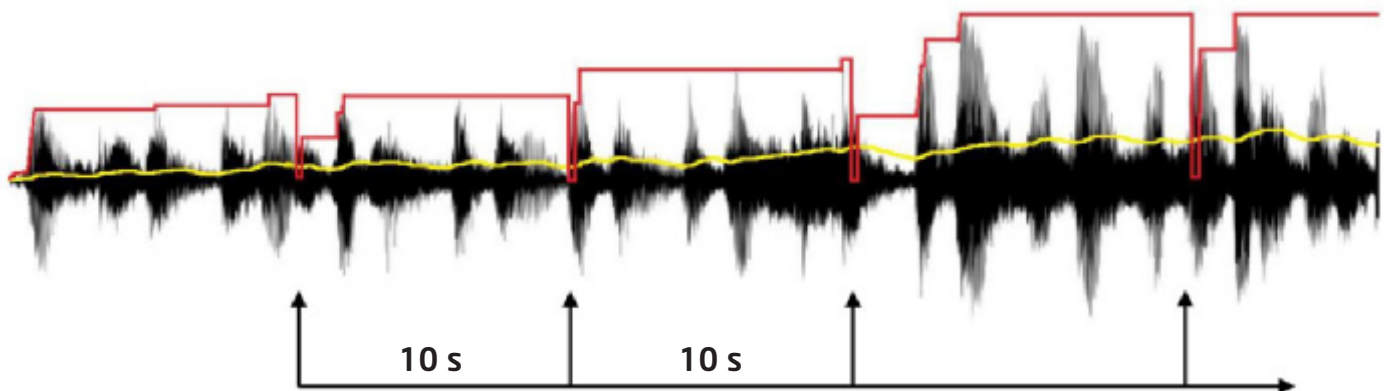

10 s sample and peak reset. For every send interval, it calculates total peak and average for all samples. Red = peak, yellow = average.

7.8 Button

The button will generate a triggered uplink message when pressed.

8 Technical Information

8.1 Specifications

Dimensions	76,2 x 76,2 x 22,5 mm
Weight	53 - 60 g excluding batteries 70 - 95 g including batteries
Enclosure	Plastic, PC/ABS
IP Rating	IP20
Mounting	Screws/Adhesive tape
Recommended installation height	Wall: 1.6 m
Usage Environment	Indoor
Operating Conditions	0 to 50 °C 0 to 85 % RH (non-condensing)
Operating Voltage	3.6 V DC
Battery Type	AA 14505 Li-SOCl ₂
Battery Life	Up to 10 years (Depending on settings and environmental factors)
Wireless Technology	LoRaWAN® 1.0.4, Regional Parameters RP2 - 1.0.3
Wireless Security	LoRaWAN® End-to-End encryption (AES-CTR), Data Integrity Protection (AES-CMAC)
LoRaWAN® Device Type	Class A End-device
Supported LoRaWAN® regions	EU868, IN865, US915, AU915, AS923, HK923, KR923
Supported LoRaWAN® features	OTAA, ABP, ADR, Adaptive Channel Setup
Link Budget	137dB (SF7) to 151 dB (SF12)
RF Transmit Power	Max 14 dBm EIRP
EU Directives Compliance	RED 2014/53/EU, RoHS 2011/65/EU, WEEE 2012/19/EU

8 Technical Information

8.2 Sensor Payload Format

The device uses the standard ELSYS payload format. Please see the specified document on our webpage.

9 Regulations

9.1 Legal Notices

All information, including, but not limited to, information regarding the features, functionality, and/or other product specification, are subject to change without notice. ELSYS reserves all rights to revise or update its products, software, or documentation without any obligation to notify any individual or entity. ELSYS and ELSYS logo are trademarks of ElektronikSystem i Umeå AB. All other brands and product names referred to herein are trademarks of their respective holders.

9.2 Federal Communication Commission Interference Statement

Notice

This device complies with Part 15 of the FCC Rules and with Industry Canada licence-exempt RSS standard(s). Operation is subject to the following two conditions:

- (1) this device may not cause harmful interference, and
- (2) this device must accept any interference received, including interference that may cause undesired operation.

Le présent appareil est conforme aux CNR d'Industrie Canada applicables aux appareils radio exempts de licence. L'exploitation est autorisée aux deux conditions suivantes:

- (1) l'appareil ne doit pas produire de brouillage, et
- (2) l'appareil doit accepter tout brouillage radioélectrique subi, même si le brouillage est susceptible d'en compromettre le fonctionnement.

FCC ID

2ANX3-ERSD1

IC ID

26904-ERSD1

Note

Changes or modifications made to this equipment not expressly approved by ElektronikSystem i Umeå AB may void the FCC authorization to operate this equipment.

9 Regulations

Notice

This equipment has been tested and found to comply with the limits for a Class B digital device, pursuant to Part 15 of the FCC Rules. These limits are designed to provide reasonable protection against harmful interference in a residential installation. This equipment generates, uses and can radiate radio frequency energy and, if not installed and used in accordance with the instructions, may cause harmful interference to radio communications. However, there is no guarantee that interference will not occur in a particular installation. If this equipment does cause harmful interference to radio or television reception, which can be determined by turning the equipment off and on, the user is encouraged to try to correct the interference by one or more of the following measures:

- Reorient or relocate the receiving antenna.
- Increase the separation between the equipment and receiver.
- Connect the equipment into an outlet on a circuit different from that to which the receiver is connected.
- Consult the dealer or an experienced radio/TV technician for help.

9.3 Declaration of Conformity

Hereby, ElektronikSystem i Umeå AB declares that the radio equipment type "Radio communication devices for low-speed data R&TTE Class 1" is in compliance with Directive 2014/53/EU, Directive 2011/65/EU and Directive 2012/19/EU.

The full text of the EU declaration of conformity is available at: <https://www.elsys.se/link/eu-doc>

10 Revision History

Revision	Description	Date
1.0	Display Series operating manual created	2023-08-24