



Industrial Router Pro Series

UR35

Quick Start Guide



Safety Precautions

Milesight will not shoulder responsibility for any loss or damage resulting from not following the instructions of this operating guide.

- The device must not be modified in any way.
- Do not place the device close to objects with naked flames.
- Do not place the device where the temperature is below/above the operating range.
- Do not power on the device or connect it to other electrical device when installing.
- Check lightning and water protection when used outdoors.
- Do not connect or power the equipment using cables that have been damaged.

Related Documents

This Start Guide only explains the installation of Milesight UR35 router. For more functionality and advanced settings, please refer to the relevant documents as below.

Document	Description
UR35 Datasheet	Datasheet for UR35 industrial cellular router.
UR35 User Guide	Users could refer to the guide for instruction on how to log in the web GUI, and how to configure all the settings.

The related documents are available on Milesight website: <https://www.milesight-iot.com>

Declaration of Conformity

UR35 are in conformity with the essential requirements and other relevant provisions of the CE, FCC, and RoHS.



© 2011-2022 Xiamen Milesight IoT Co., Ltd.

All rights reserved.

All information in this guide is protected by copyright law. Whereby, no organization or individual shall copy or reproduce the whole or part of this user guide by any means without written authorization from Xiamen Milesight IoT Co., Ltd.

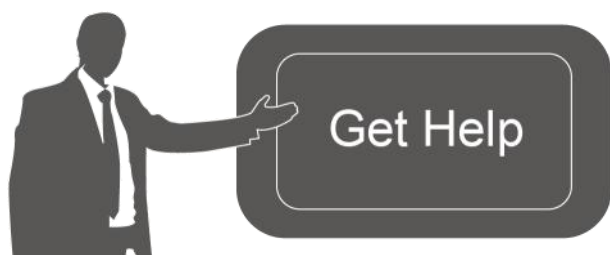

For assistance, please contact

Milesight technical support:

Email: iot.support@milesight.com

Tel: 86-592-5085280

Fax: 86-592-5023065

Address: Building C09, Software Park III, Xiamen
361024, China

Revision History

Date	Doc Version	Description
Aug. 1, 2019	V 1.0	Initial version
Feb. 11, 2020	V 1.1	1. Replace serial port picture; 2. Delete reboot descriptions of reset button
Aug. 26, 2020	V 1.2	1. Web GUI change; 2. 2.Add -485 model
Nov. 20, 2020	V 2.0	Layout replace
Dec. 1, 2021	V 2.1	Update cellular pictures
June 8, 2022	V 2.2	1. Wall mounting bracket customizable 2. Web GUI logo update

Contents

1. Packing List	5
2. Hardware Introduction	6
2.1 Overview	6
2.2 Dimensions	6
2.3 Serial & IO & Power Pinouts	7
2.4 LED Indicators	7
2.5 Reset Button	8
2.6 Ethernet Port Indicator	8
3. Hardware Installation	9
3.1 SIM Card/Micro SD Card Installation	9
3.2 Antenna Installation	9
3.3 Router Installation	9
3.3.1 DIN Rail Mounting	10
3.3.2 Wall Mounting	10
3.4 Protective Grounding Installation	10
4. Log in the Web GUI of Router	11
5. Network Configuration	13
5.1 Ethernet WAN Configuration	13
5.2 Cellular Connection Configuration	13

1. Packing List

Before you begin to install the UR35 router, please check the package contents to verify that you have received the items below.

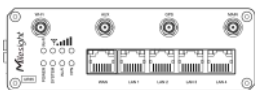

1 × UR35



1 × Ethernet Cable

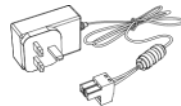

1 × Power Adapter



2 × Magnetic Cellular
Antennas



1 × 8-Pin Pluggable
Terminal

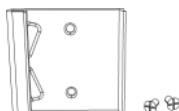

1 × DIN Rail Kit



1 × Quick Start Guide



1 × Warranty Card



1 × Stubby Wi-Fi
Antenna
(Wi-Fi Version Only)



1 × GPS Antenna
(GPS Version Only)



2 × Stubby Cellular
Antennas (Optional)

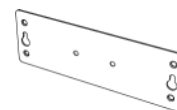

1 × Wall Mounting
Bracket
(Customizable)



If any of the above items is missing or damaged, please contact your sales representative.

2. Hardware Introduction

2.1 Overview

A. Front Panel

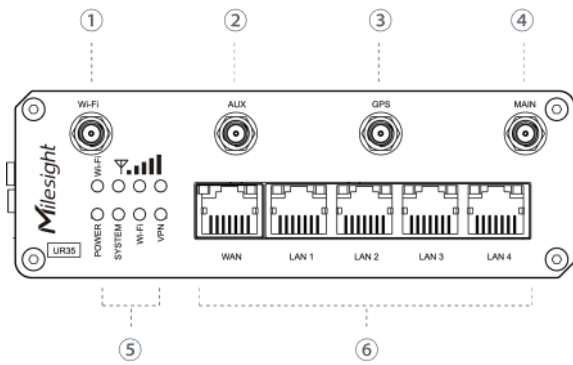

- ① Wi-Fi Antenna Connector
- ② AUX Antenna Cellular Connector
- ③ GPS Antenna Connector
- ④ MAIN Cellular Antenna Connector
- ⑤ LED Indicator Area
 POWER: Power Indicator
 SYSTEM: Status Indicator
 Wi-Fi: Wi-Fi Indicator
 VPN: VPN Indicator
 SIM : SIM Status Indicator
 ▽ : Signal Strength Indicator
- ⑥ Ethernet Port & Indicator

B. Left Side Panel

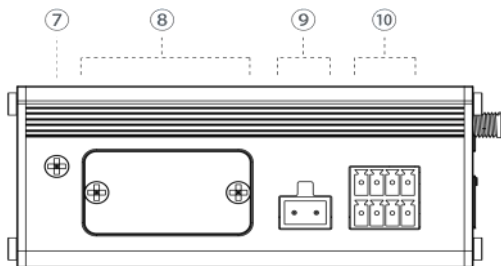

- ⑦ Grounding Stud
- ⑧ SIM and Reset Button Holder
- ⑨ Power Connector
- ⑩ Serial Port & I/O

2.2 Dimensions (mm)

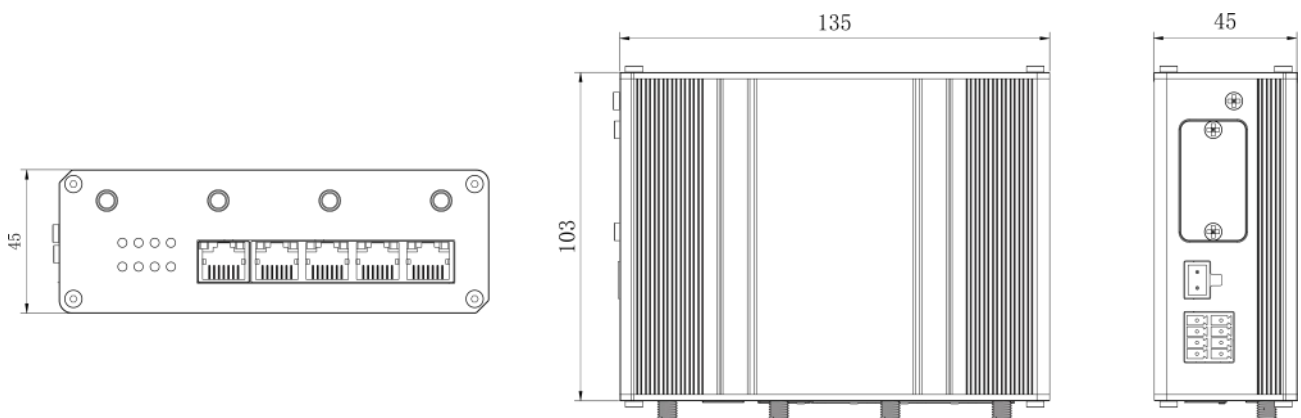

2.3 Serial & IO & Power Pinouts

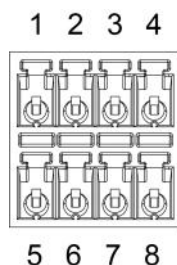

PIN	RS232	RS485	DI	DO	Description
1	---	---	IN	---	Digital Input
2	GND	---	GND	---	Ground
3	---	B	---	---	Data -
4	TXD	---	---	---	Transmit Data
5	---	---	---	COM	Common Ground
6	---	---	---	OUT	Digital Output
7	---	A	---	---	Data +
8	RXD	---	---	---	Receive Data

Note: For -RS485 model, RXD--->A, TXD--->B.



9 10

PIN	Description	Wire Color
9	Positive	Red
10	Negative	Black

2.4 LED Indicators

LED	Indication	Status	Description
POWER	Power Status	Off	The power is switched off
		On	The power is switched on
SYSTEM	System Status	Green Light	Static: Start-up Blinking slowly: the system is running properly
		Red Light	The system goes wrong
VPN	VPN Status	Off	VPN is disconnected
		Green Light	VPN is connected
Wi-Fi	Wi-Fi Status	Off	Wi-Fi is disabled
		Green Light	Static: Wi-Fi is enabled Blinking slowly: sending or receiving data via Wi-Fi
SIM	SIM Card Status	Off	SIM1 or SIM2 is registering or fails to register (or there are no SIM cards inserted)
		Green Light	Blinking slowly: SIM1 (as primary SIM) has been registered and is ready for dial-up
			Blinking rapidly: SIM1(as primary SIM) has been registered and is dialing up now
		Orange Light	Static: SIM1 (as primary SIM) has been registered and dialed up successfully
Blinking slowly: SIM2 (as primary SIM) has been registered and is ready for dial-up			
	Blinking rapidly: SIM2 (as primary SIM) has been		

			registered and is dialing up now
			Static: SIM2 (as primary SIM) has been registered and dialed up successfully
Signal Strength	Signal 1/2/3	Off	No signal
		Green Light	Static/Off/Off: weak signals with 1-10 ASU (please check if the antenna is installed correctly, or move the antenna to a suitable location to get better signal)
			Static/Static/Off: normal signals with 11-20 ASU (average signal strength)
			Static/Static/Static: strong signals with 21-31 ASU (signal is good)

2.5 Reset Button

Reset button is under the SIM slots.

Function	Description	
	SYSTEM LED	Action
Reset	Blinking	Press and hold the reset button for more than 5 seconds.
	Static Green → Rapidly Blinking	Release the button and wait.
	Off → Blinking	The router is now reset to factory defaults.

2.6 Ethernet Port Indicator

Indicator	Status	Description
Link Indicator (Orange)	On	Connected
	Blinking	Transmitting data
	Off	Disconnected

3. Hardware Installation

Environmental Requirements

- Power Input: 9-48 VDC (48 VDC is needed for PoE output)
- Power Consumption: Typical 3.9 W (Max 4.6 W)
- Operating Temperature: -40°C to 70°C (-40°F -158°F)
- Relative Humidity: 0% to 95% (non-condensing) at 25°C/77°F

3.1 SIM Card/Micro SD Card Installation



UR35 do not support hot-plug. Please cut off the power before insert or take off cards.

A. Unscrew the cover of the SIM card then take it off.

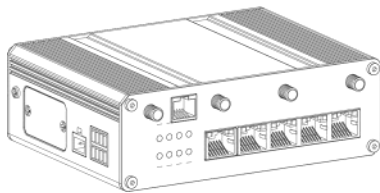

B. Put SIM card/Micro SD into the slot and screw it up.

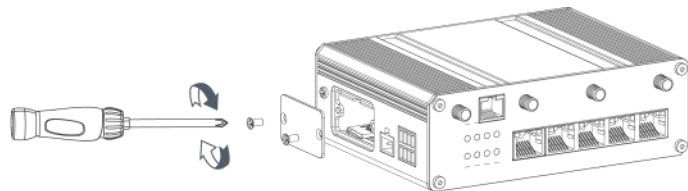

3.2 Antenna Installation

Rotate the antenna into the antenna connector accordingly. The external antenna should be installed vertically always on a site with a good signal.

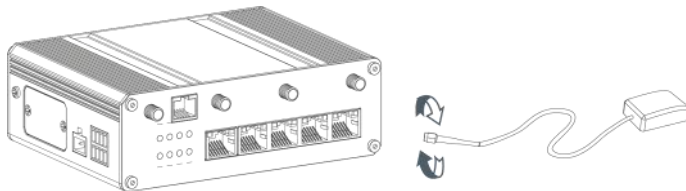
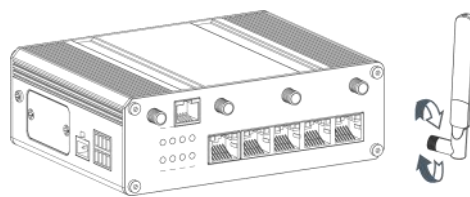
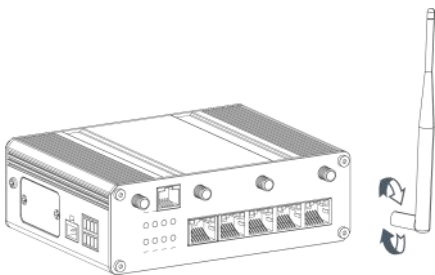

3.3 Router Installation

The router can be placed on a desktop or mounted to a wall or a DIN rail.

3.3.1 DIN Rail Mounting (Measured in mm)

Use 2 pcs of M3 × 6 flat head Phillips screws to fix the mount clip to the router, and then hang the device to the DIN rail. The width of DIN rail is 3.5cm.

! Recommended torque for mounting is 1.0 N·m, and the maximum allowed is 1.2 N·m.

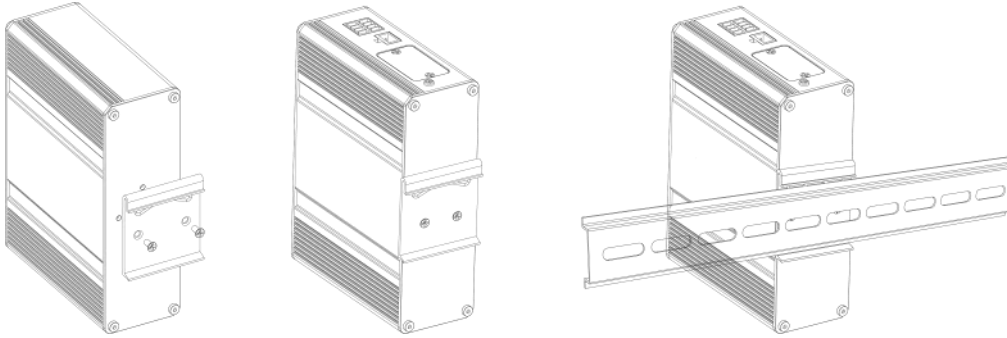

3.3.2 Wall Mounting (Measured in mm)

Use 2 pcs of M3 × 6 flat head Phillips screws to fix the wall mounting bracket to the router, and then use 2 pcs of M3 drywall screws to mount the router associated with the wall plugs on the wall.

! Recommended torque for mounting is 1.0 N·m, and the maximum allowed is 1.2 N·m.

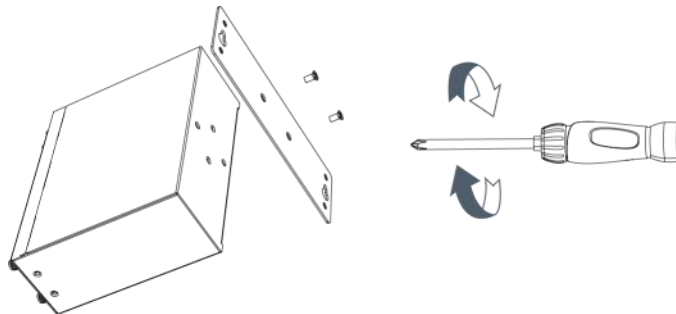

3.4 Protective Grounding Installation

Remove the grounding nut, then connect the grounding ring of the cabinet's grounding wire onto the grounding stud and screw up the grounding nut.

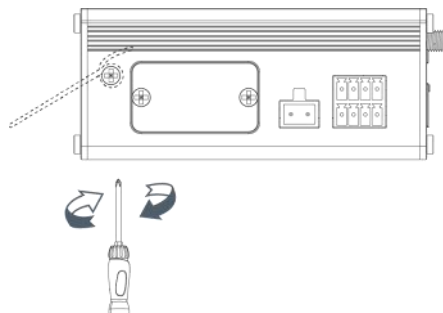

! The router must be grounded when deployed. According to operating environment, the ground wire should be connected with grounding stud of router.

4. Log in the Web GUI of Router

Please connect PC to LAN port of UR35 router. PC can obtain an IP address, or you can configure a static IP address manually. The following steps are based on Windows 10 operating system for your reference.

IP Address: **192.168.1.1**

Username: **admin**

Password: **password**

A. Go to “Control Panel” → “Network and Internet” → “Network and Sharing Center”, then click “Ethernet” (May have different names).

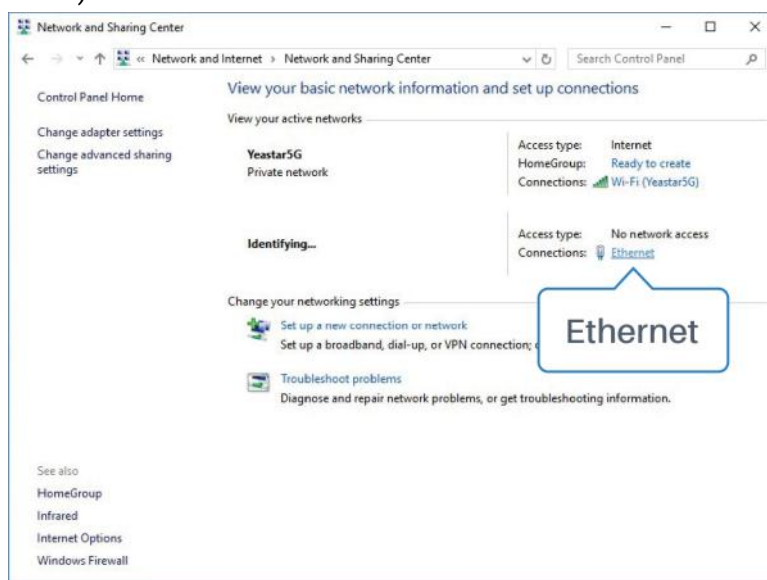

B. Go to “Properties” → “Internet Protocol Version 4(TCP/IPv4)”, select “Obtain an IP address automatically” or “Use the following IP address”, then assign a static IP manually within the same subnet of the device.

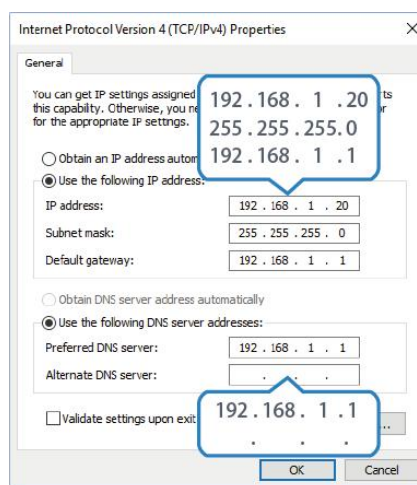
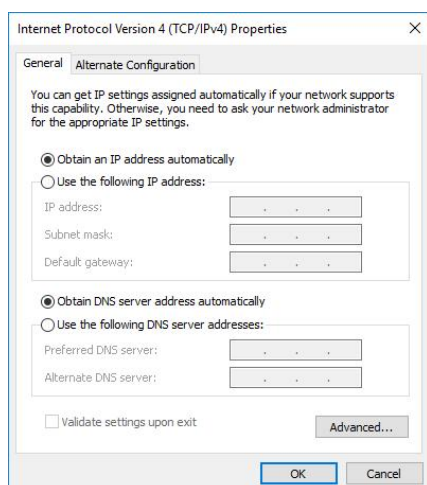

C. Open a Web browser on your PC (Chrome is recommended), type in the IP address 192.168.1.1, and press Enter on your keyboard.

D. Enter the username, password, and click "Login".

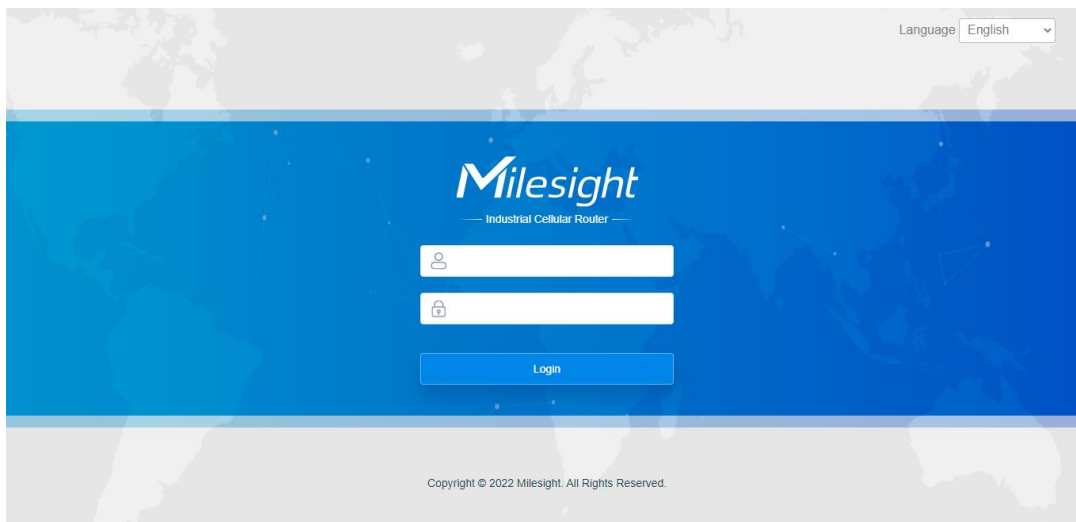

! If you enter the username or password incorrectly more than 5 times, the login page will be locked for 10 minutes.

E. When you login with the default username and password, you will be asked to modify the password. It's suggested that you change the password for the sake of security. Click "Cancel" button if you want to modify it later.

Change Password ✕

Old Password

New Password

Confirm New Password

Save
Cancel

F. After you login the Web GUI, you can view system information and perform configuration on the router.

5. Network Configuration

This chapter explains how to connect UR35 to network via WAN connection or cellular.

5.1 Ethernet WAN Configuration

A. Go to “Network” → “Interface” → “WAN” to select connection type and configure WAN parameters, click “Save & Apply” button to make the changes take effect.

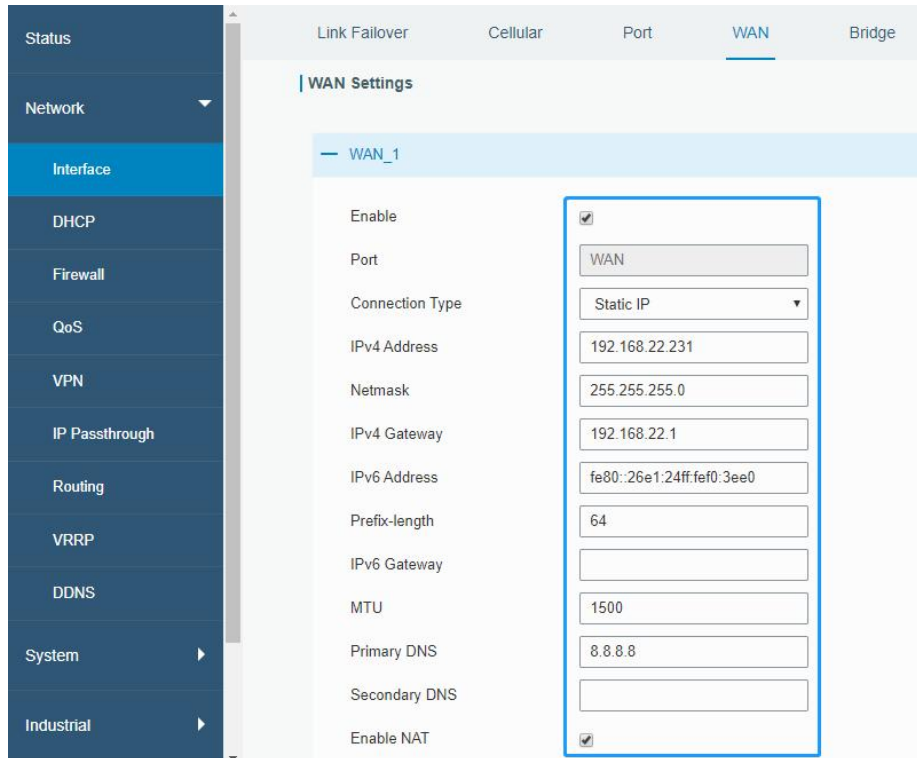

B. Connect WAN port to another network devices like modem.

C. Go to “Network” → “Interface” → “Link Failover” to rise the WAN priority to 1.

D. Open your preferred browser on PC, then type any available web address into address bar and see if it is able to visit Internet via UR35 router.

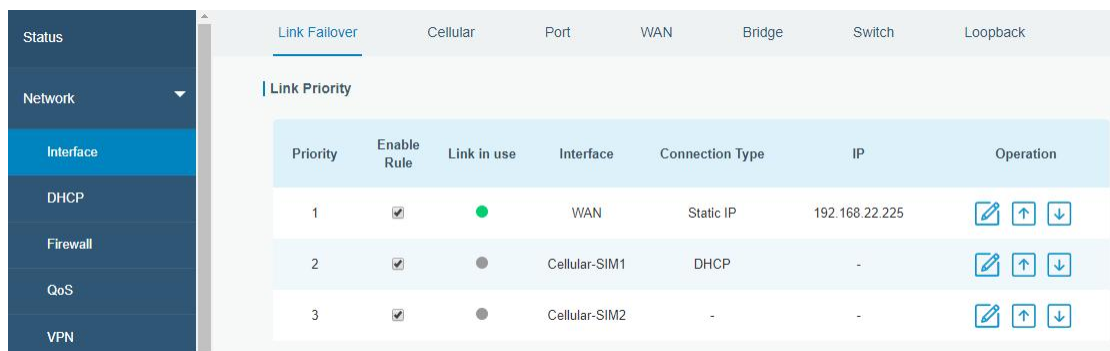

Priority	Enable Rule	Link in use	Interface	Connection Type	IP	Operation
1	<input checked="" type="checkbox"/>	●	WAN	Static IP	192.168.22.225	✎ ↑ ↓
2	<input checked="" type="checkbox"/>	●	Cellular-SIM1	DHCP	-	✎ ↑ ↓
3	<input checked="" type="checkbox"/>	●	Cellular-SIM2	-	-	✎ ↑ ↓

5.2 Cellular Connection Configuration

Take inserting SIM card into SIM1 slot as an example; please refer to the following detailed operations.

A. Go to “Network” → “Interface” → “Cellular” → “Cellular Setting” to configure APN, PIN code or other

cellular info, click “Save” and “Apply” to save the configuration.

Cellular Settings

	SIM1	SIM2
Protocol Type	IPv4	IPv4
APN		
Username		
Password		
PIN Code		
Access Number		
Authentication Type	Auto	Auto
Network Type	Auto	Auto
PPP Preferred	<input type="checkbox"/>	<input type="checkbox"/>
SMS Center		
Enable NAT	<input checked="" type="checkbox"/>	<input checked="" type="checkbox"/>

B. Go to “Network” → “Interface” → “Link Failover” to enable SIM1 and rise link priority of SIM1.

Link Priority

Priority	Enable Rule	Link in use	Interface	Connection Type	IP	Operation
1	<input checked="" type="checkbox"/>	<input type="checkbox"/>	Cellular-SIM1	-	-	
2	<input checked="" type="checkbox"/>	<input type="checkbox"/>	Cellular-SIM2	DHCP	-	
3	<input checked="" type="checkbox"/>	<input checked="" type="checkbox"/>	WAN	Static IP	192.168.22.225	

C. Click to configure ICMP ping detection information.

Ping Detection

Enable

IPv4 Primary Server

IPv4 Secondary Server

IPv6 Primary Server

IPv6 Secondary Server

Interval s

Retry Interval s

Timeout s

Max Ping Retries

D. Click “Status” → “Cellular” to view the status of the cellular connection. If it shows “Connected”, it means SIM1 has dialed up successfully. On the other hand, you can check the status of SIM indicator. If it keeps on green light statically, it means SIM1 has dialed up successfully.

Overview	Cellular	Network	VPN	Routing	Host List	GPS
Modem		Network				
Status	Ready	Status	Connected			
Model	EC25	IP Address	10.2.25.74			
Current SIM	SIM1	Netmask	255.255.255.240			
Signal Level	29asu (-55dBm)	Gateway	10.2.25.73			
Register Status	Registered (Home network)	DNS	211.136.17.107			
IMEI	861585042050250	Connection Duration	0 days, 00:00:34			
IMSI	460045927703654	Data Usage Monthly				
ICCID	89860439101880723654	SIM-1	RX: 0.0 MiB TX: 0.0 MiB ALL: 0.0 MiB			
ISP	CHINA MOBILE	SIM-2	RX: 0.0 MiB TX: 0.0 MiB ALL: 0.0 MiB			
Network Type	FDD LTE					
PLMN ID	46000					
LAC	592f					
Cell ID	271f848					

E. Open your preferred browser on PC, then type any available web address into address bar and see if it is able to visit Internet via UR35 router.

[END]