

AI Workplace Sensor VS121

Featuring LoRaWAN[®]

User Guide

Safety Precautions

Milesight will not shoulder responsibility for any loss or damage resulting from not following the instructions of this operating guide.

- ❖ The device must not be disassembled or remodeled in any way.
- ❖ To avoid risk of fire and electric shock, do keep the product away from rain and moisture before installation.
- ❖ Do not place the device where the temperature is below/above the operating range.
- ❖ Do not touch components which may be hot.
- ❖ The device must never be subjected to shocks or impacts.
- ❖ Make sure the device is firmly fixed when installing.
- ❖ Make sure the plug is firmly inserted into the power socket.
- ❖ Do not expose the device to where a laser beam equipment is used.
- ❖ Use a soft, dry cloth to clean the lens of the device. Stubborn stains can be removed using a cloth dampened with a small quantity of detergent solution, then wipe them dry.

Declaration of Conformity

VS121 is in conformity with the essential requirements and other relevant provisions of the CE, FCC, and RoHS.

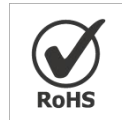

Copyright © 2011-2021 Milesight. All rights reserved.

All information in this guide is protected by copyright law. Whereby, no organization or individual shall copy or reproduce the whole or part of this user guide by any means without written authorization from Xiamen Milesight IoT Co., Ltd.

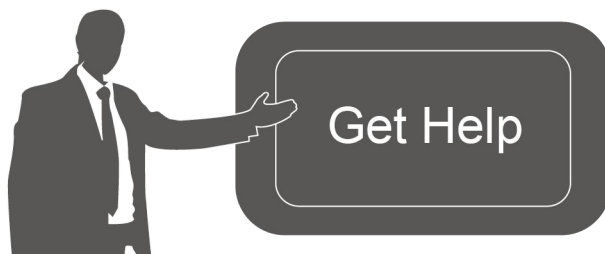

For assistance, please contact

Milesight technical support:

Email: iot.support@milesight.com

Tel: 86-592-5085280

Fax: 86-592-5023065

Address: 4/F, No.63-2 Wanghai Road,

2nd Software Park, Xiamen, China

Revision History

Date	Doc Version	Description
Apr. 26, 2021	V 1.0	Initial version

Contents

1. Product Introduction.....	5
1.1 Overview.....	5
1.2 Key Features.....	5
2. Hardware Introduction.....	5
2.1 Packing List.....	5
2.2 Hardware Overview.....	6
2.3 Buttons and LED Indicators.....	6
2.4 Dimensions(mm).....	6
3. Access the Sensor.....	7
3.1 Access without Plugin.....	7
3.2 Access with Plugin.....	8
4. Operation Guide.....	10
4.1 Live Video.....	10
4.2 IoT.....	11
4.2.1 People Counting.....	11
4.2.2 LoRa.....	12
4.2.3 Wi-Fi.....	14
4.3 Advanced Settings.....	15
4.3.1 Security.....	15
4.3.2 Logs.....	16
4.4 System.....	17
4.5 Maintenance.....	17
4.5.1 System Maintenance.....	17
4.5.2 Auto Reboot.....	18
5. Installation.....	19
6. Device Payload.....	19

1. Product Introduction

1.1 Overview

VS121, based on Artificial Intelligence (AI) technology, is an AI workplace sensor designed to monitor occupancy & utilization in modern workspace, which can reach up to 95% recognition rate. With the ability to sense from up to 78m², fewer sensors are needed to cover the same area, decreasing the deploy costs for users. Only counter values are transmitted over LoRaWAN[®] network to prevent the privacy concerns. VS121 is equipped with Wi-Fi for easy configuration without any tools.

Sensor data are transmitted in real-time using standard LoRaWAN[®] protocol. LoRaWAN[®] enables encrypted radio transmissions over long distance while consuming very little power. The user can obtain sensor data and view the trend of data change through the user's own network server.

1.2 Key Features

- Recognition rate is up to 95% based on advanced AI identification and analysis technology and wide detection range
- Support to map up to 12 custom regions
- No image data is collected, free from privacy concerns
- Equipped with Wi-Fi for web GUI configuration
- Function well with standard LoRaWAN[®] gateways and network servers

2. Hardware Introduction

2.1 Packing List



1 × VS121 Sensor



Wall Mounting
Kits



1 ×
Type-C Cable (1 m) &
Power Adapter

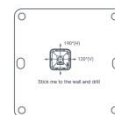

1 ×
Mounting Sticker



1 ×

Warranty Card



1 ×

Quick Guide



If any of the above items is missing or damaged, please contact your sales representative.

2.2 Hardware Overview

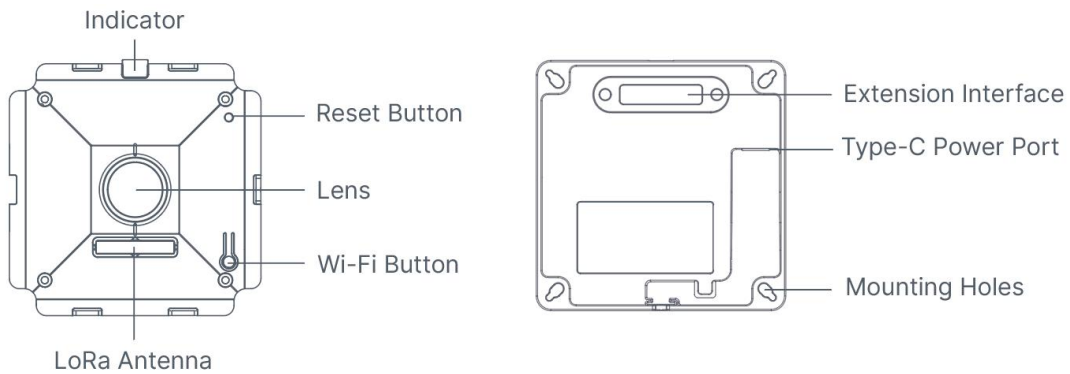

2.3 Buttons and LED Indicators

Function	Action	LED Indication
Turn On/Off Wi-Fi	Press and hold the Wi-Fi button for more than 3 seconds.	Off → On
	Press and hold the Wi-Fi button for more than 3 seconds.	On → Off
Reset to Factory Default	Press and hold the reset button for more than 10 seconds.	Blinks 6 times.

2.4 Dimensions(mm)

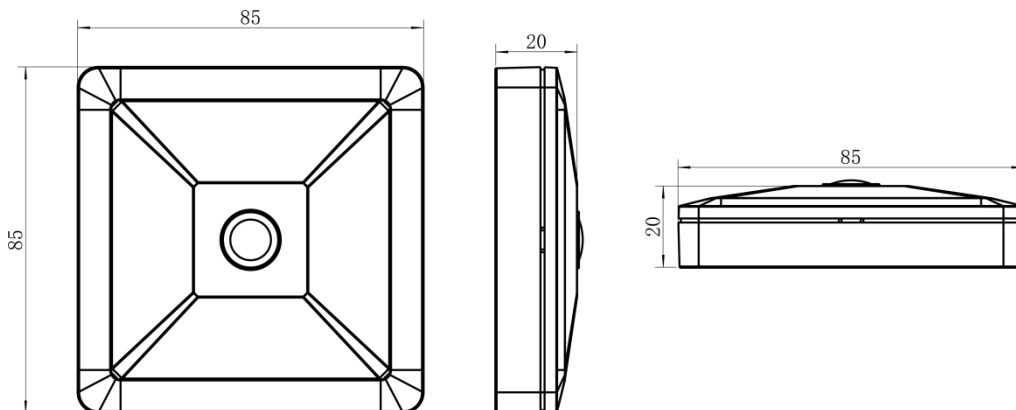

3. Access the Sensor

VS121 sensor provides user-friendly web GUI for configuration and users can access it via Wi-Fi connection. The recommended browsers are Internet Explorer, Firefox, Chrome, Microsoft Edge, Safari. The default IP of sensor is 192.168.1.1, and default SSID is Vision Sensor_XXXXXX (can be found on the label).

3.1 Access without Plugin

Step 1: Power on the device.

Step 2: Enable the Wireless Network Connection on your computer and search for corresponding access point, then connect computer to this access point.

Step 3: Open the Browser and type 192.168.1.1 to access the web GUI.

Step 4: Select the language.

Step 5: Users need to set the password when using the sensor for the first time. And three security questions can also be set optionally. After configuration, use username (admin) and custom password to log in the sensor.

Note:

- 1) Password must be 8 to 32 characters long, contain at least one number and one letter.
- 2) You can click the "forget password" in login page to reset the password by answering three security questions when you forget the password, if you set the security questions in advance.

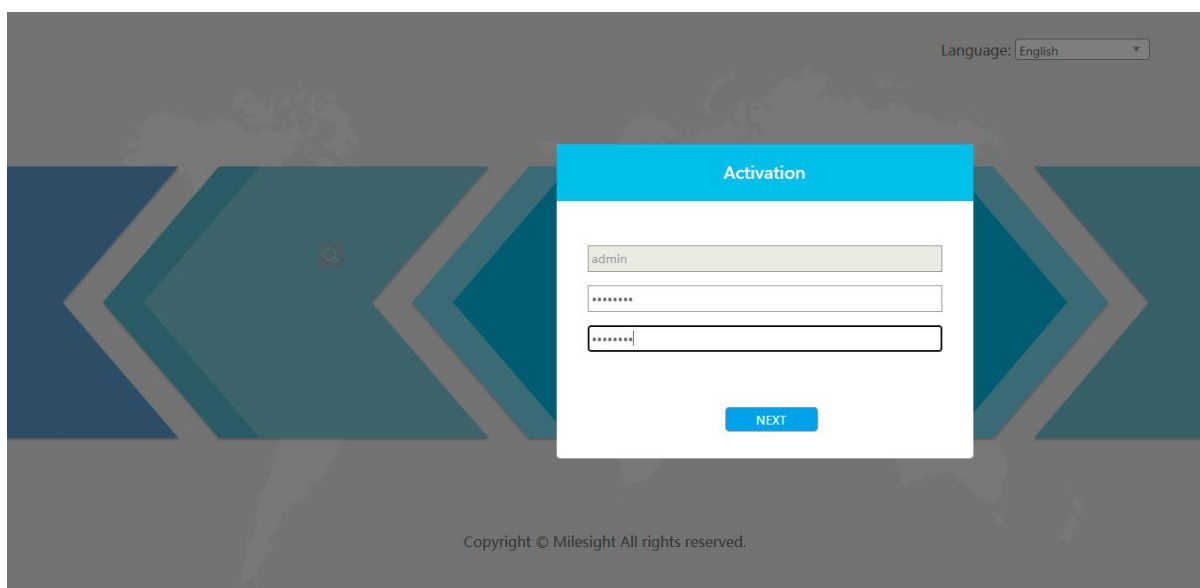

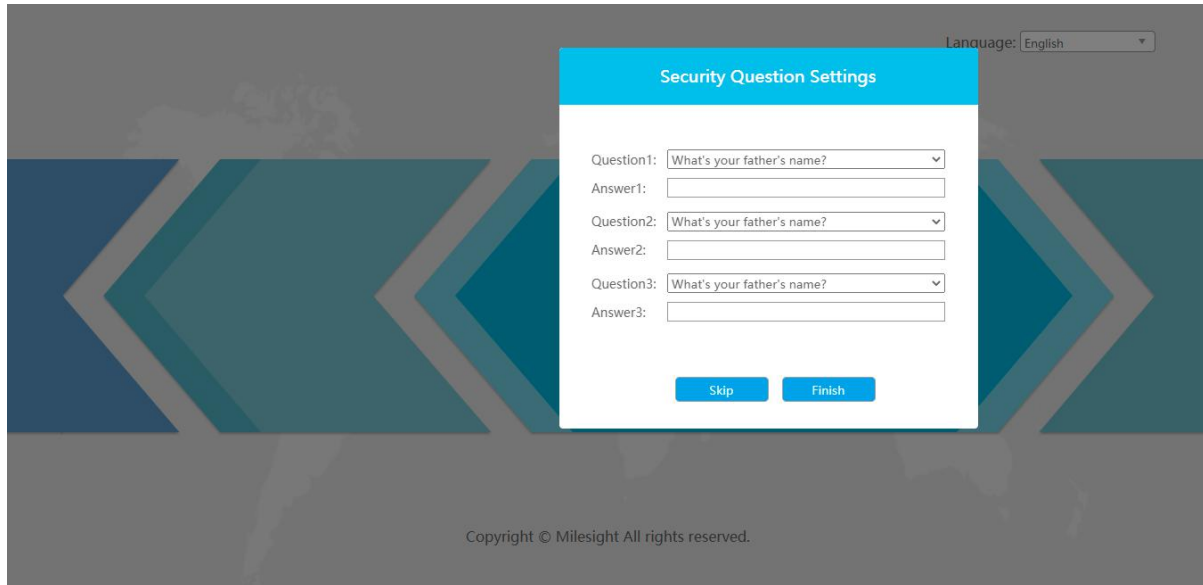

3.2 Access with Plugin

For IE browser access, users need to install the MsActiveX firstly. You can refer the steps as follows:

Step1: Launch the IE browser and enter the IP address of the sensor;

Step2: Enter the user name and custom password and click "Login";

Step3: At the first time to log in the device, the browser will prompt to install Controls, please click "Click here to download and install controls manually" as shown below;

Click here to download and install controls manually

Note: During installing the controls, please keep the browsers close.

Step4: Follow the prompts to install the Controls, when it's finished, it will pop out a window as shown below. Please click "Finish" and refresh the browser, then you will see the video.

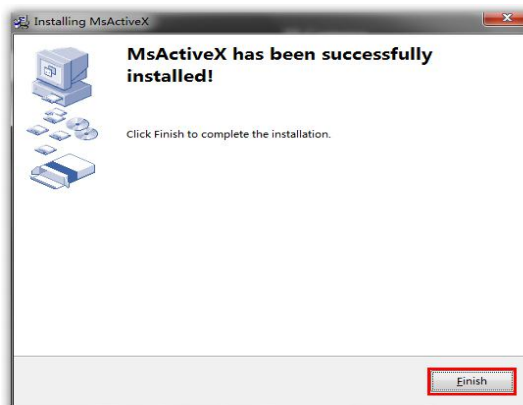

If IE9 or higher version browser is used, it is suggested that the web link should be added as a trusted site. See the instructions as follows:

Step1: Start the IE9 or higher version browser, and select "Tools" → "Internet Options";

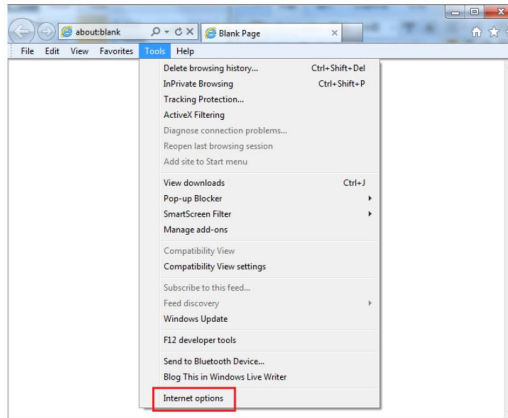

Step2: Select "Security" to "Trusted";

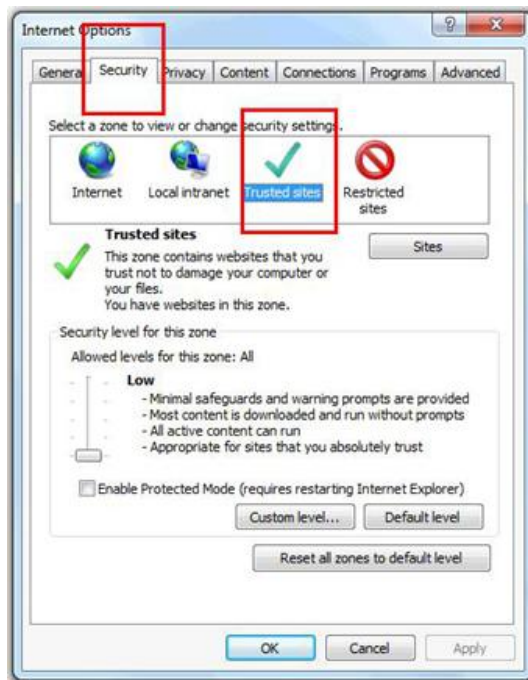

Step3: Enter the IP address of the camera in the blank and click "Add";

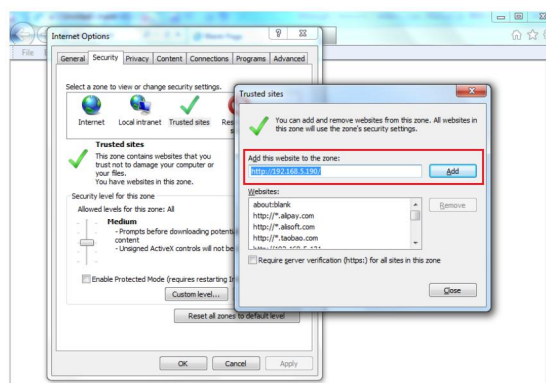

Step4: Enter the IP address. After logging on web GUI successfully, user is allowed to view live video.



4. Operation Guide

4.1 Live Video

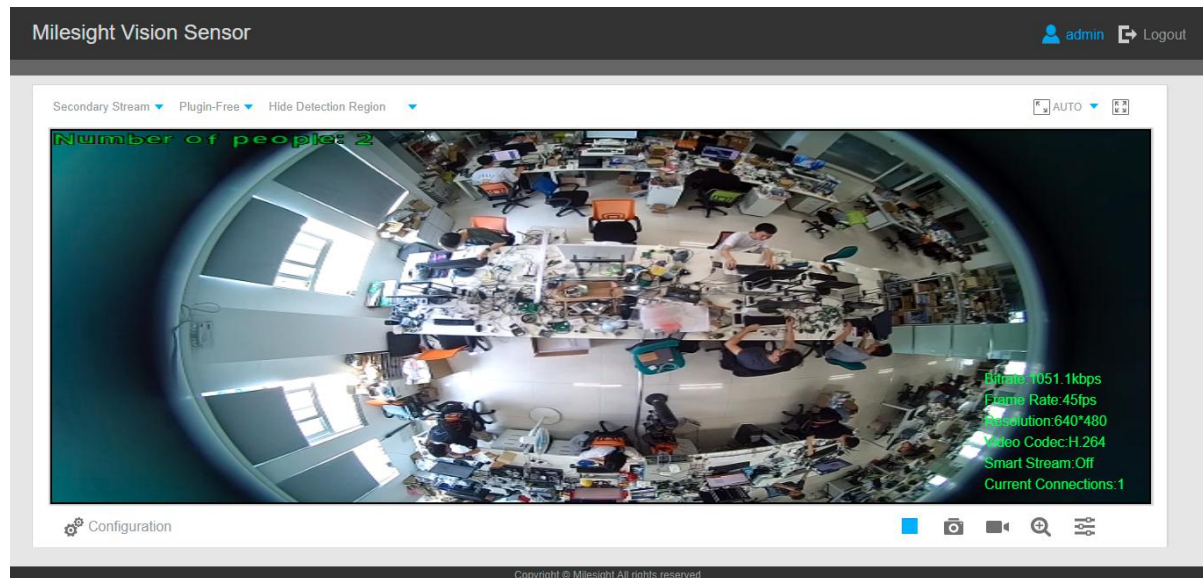
After logging in the network camera web GUI successfully, user is allowed to view live video as follows.



Parameters	Description
<p>Image Config</p>	<p>Brightness: Adjust the Brightness of the scene</p> <p>Contrast: Adjust the color and light contrast</p> <p>Saturation: Adjust the Saturation of the image. Higher Saturation makes colors appear more "pure" while lower one appears more "wash-out"</p> <p>Sharpness: Adjust the Sharpness of image. Higher Sharpness sharps the pixel boundary and makes the image looks "more clear"</p> <p>2D DNR/3D DNR: Adjust the noise reduction level</p> <p>Default: Restore brightness, contrast and saturation to default settings</p>
<p>Configuration</p>	<p>Click to access the configuration page</p>
<p>Hide Detection Region</p>	<p>People Counting (Region): Show the mapped or non-mapped regions of people counting</p> <p>Hide Detection Region: hide people detection region</p>
<p>Window size</p>	<p>Click to display images at a window size</p>
<p>Real size</p>	<p>Click to display images at a real size</p>

 Full Screen	Click to display images at full-screen
 	Start/Stop live view
 Enable Digital Zoom	When enabled, you can zoom in in a specific area of video image with your mouse wheel

4.2 IoT

4.2.1 People Counting

Users can set the report settings and detection regions here.

IoT

People Counting
LoRa
Wi-Fi

Number of People: 0

Settings

Report Regularly:

Reporting Interval (s):

Report by Result:

Mode:

Set Detection Region

Enable:

Detection Area:

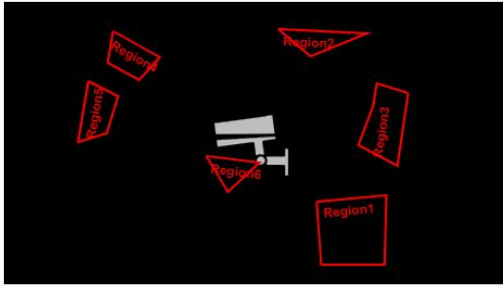

Note: The number of edges can't exceed 10 and only support up 12 regions.s

Parameters	Description
Number of People	Show current number of people.
Report Regularly	Report the number of people according to reporting interval. Reporting Interval: 5-3600s
Report by Result	Report according to following people number results:

	<ul style="list-style-type: none"> ● Zero and Non-zero ● Once result changes
Enable	Enable the detection area customization feature. If disabled, the whole area will be detection area.
Detection Area	Select the customized area as either mapped or except mapped area. You can draw the area in the below screen. 12 areas can be set at most. Mapped Region: Only people in mapped region will be detected Non-mapped Region: Only people in except mapped region will be detected
Clear	Clear all areas you draw before

4.2.2 LoRa

LoRa settings is used for configuring the transmission parameters in LoRaWAN® network.

IoT

People Counting
[LoRa](#)
Wi-Fi

Status:	De-activated
Basic Settings	
Device EUI:	24E124600B094097
App EUI:	<input type="text" value="24E124C0002A0001"/>
Join Type:	<input type="text" value="OTAA"/>
Application Key:	<input type="text" value="*****"/>
Advanced Settings	
Confirmed Mode:	<input checked="" type="checkbox"/>
ADR:	<input checked="" type="checkbox"/>
Rejoin Mode:	<input checked="" type="checkbox"/>
LinkCheckReq Message Retries:	<input type="text" value="8"/>
Port:	<input type="text" value="85"/>
Spreading Factor:	<input type="text" value="SF10-DR2"/>
LoRaWAN Version:	<input type="text" value="V1.1.0"/>
Region:	<input type="text" value="CN470"/>
Channel:	<input type="text" value="0-95"/> ⓘ
Index	Frequency/MHz
0-15	470.3-473.3
16-31	475.5-476.5
32-47	477.3-478.3

Parameters	Description
Status	LoRaWAN® network status of this device.
Device EUI	Unique ID of the device which can also be found on the label.
App EUI	Default App EUI is 24E124C0002A0001.
Join Type	OTAA and ABP mode are available.

Application Key	Appkey for OTAA mode, default is 5572404C696E6B4C6F52613230313823.
Device Address	DevAddr for ABP mode, default is the 5 th to 12 th digits of SN.
Network Session Key	Nwkskey for ABP mode, default is 5572404C696E6B4C6F52613230313823.
Application Session Key	Appskey for ABP mode, default is 5572404C696E6B4C6F52613230313823.
Confirmed Mode	If the device does not receive ACK packet from network server, it will resend data 3 times at most.
ADR Mode	Allow network server to adjust data rate of the device.
Rejoin Mode	Reporting interval \leq 30 mins: device will send specific mounts of LoRa MAC packets to check connection status every 30 mins; If no reply after specific packets, the device will re-join. Reporting interval $>$ 30 mins: device will send specific mounts of LoRaMAC packets every to check connection status every reporting interval; If no reply after specific packets, the device will re-join.
Application Port	The port used for sending and receiving data, default port is 85.
Spreading Factor	If ADR is disabled, the device will send data via this spreading factor.
LoRaWAN Version	V1.0.2, V1.0.3, V1.1.0 are available.
Region	Frequency plan of this device.
Channel	Enter the index to select the frequency channel. Examples: 1, 40: Enabling Channel 1 and Channel 40 1-40: Enabling Channel 1 to Channel 40 1-40, 60: Enabling Channel 1 to Channel 40 and Channel 60 All: Enabling all channels Null: Indicates that all channels are disabled

Note:

- 1) Please contact sales for device EUI list if there are many units.
- 2) Please contact sales if you need random App keys before purchase.
- 3) Only OTAA mode supports rejoin mode.
- 4) For -868M model, default frequency is EU868; for -915M model, default frequency is AU915.

4.2.3 Wi-Fi

IoT

People Counting
LoRa
Wi-Fi

Enabled:	<input checked="" type="checkbox"/>
Work Mode:	AP
SSID:	<input type="text" value="Vision Sensor_F00161"/>
Protocot:	<input type="text" value="802.11n (2.4G)"/>
Bandwidth:	<input type="text" value="20MHz"/>
Channel:	<input type="text" value="auto"/>
Security Mode:	<input type="text" value="No Encryption"/>
DHCP Server Settings:	
LAN IP Address:	<input type="text" value="192.168.1.1"/>
Subnet mask:	<input type="text" value="255.255.255.0"/>
Start Address:	<input type="text" value="192.168.1.100"/>
End Address:	<input type="text" value="192.168.1.199"/>
Lease Time (min):	<input type="text" value="1440"/>
Primary DNS Server:	<input type="text" value="114.114.114.114"/>
Secondary DNS Server:	<input type="text" value="8.8.8.8"/>
Static IP	
MAC Address	IP Address
<input type="text"/>	<input type="text"/> x
<input type="text"/>	<input type="text"/> +

Parameters	Description
Enabled	Enable Wi-Fi feature.
Work Mode	Work mode is fixed as AP and can not connect to other access point.
SSID	The unique name for this sensor Wi-Fi access point.
Protocol	802.11b (2.4G), 802.11g (2.4G), 802.11n (2.4G) are optional.
Bandwidth	20MHz or 40MHz are optional.
Channel	Select the wireless channel. Auto, 1,...11 are optional.
Security Mode	No Encryption, WEP Open System, WEP Shared Key, WPA-PSK, WPA2-PSK"and "WPA-PSK/WPA2-PSK are optional.
DHCP Server Settings	LAN IP Address: IP address that used to access the web GUI of sensor.
	Subnet mask: identify the subnet where the sensor is located.
	Start Address: define the beginning of IP address pool which assigns to DHCP clients.
	End Address: define the end of IP address pool which assigns to DHCP clients.
	Lease Time (min): the lease time on which DHCP client can use the IP address assigned by the sensor.

	<p>Primary DNS Server: translate the domain name to IP address.</p> <p>Secondary DNS Server: backup DNS server.</p>
Static IP Settings	Add MAC address and static IP address if users need to add a static IP address to a specific computer.

4.3 Advanced Settings

4.3.1 Security

User

Security Question

Security Question: Edit

Account Management

Add
Edit
Delete

ID	User Name	Privilege
1	admin	Administrator

Admin Password:

User Level: Operator ▼

User Name:

Password:

Confirm:

Parameters	Description
Security Question	<p>Click Edit button to set three security questions for your sensor. In case that you forget the password, you can click Forget Password button on login page to reset the password by answering three security questions correctly.</p> <div style="border: 1px solid #ccc; padding: 10px; margin: 10px 0;"> <div style="background-color: #f0f0f0; padding: 5px; border-bottom: 1px solid #ccc;">Milesight Network Camera ✕</div> <div style="text-align: center; color: #0070c0; font-weight: bold; margin-bottom: 10px;">Security Question Settings</div> <p>Admin Password: <input type="password"/></p> <p>Security Question1: What's your father's name? ▼</p> <p>Answer1: <input type="text"/></p> <p>Security Question2: What's your father's name? ▼</p> <p>Answer2: <input type="text"/></p> <p>Security Question3: What's your father's name? ▼</p> <p>Answer3: <input type="text"/></p> <p style="text-align: center; margin-top: 10px;">Save</p> </div>

	<p>There are twelve default questions below, you can also customize the security questions.</p> <div style="border: 1px solid black; padding: 5px; margin: 10px 0;"> <p>What's your father's name? What's your favorite sport? What's your mother's name? What's your mobile number? What's your first pet's name? What's your favorite book? What's your favorite game? What's your favorite food? What's your lucky number? What's your favorite color? What's your best friend's name? Where did you go on your first trip? Customized Question</p> </div>
<p>Account Management</p>	<p>Click Add button, it will display Account Management page. Users can add an account by entering Admin Password, User Level, User Name, New Password, Confirm, and edit user privilege by clicking <input type="checkbox"/>. The added account will be displayed in the account list. Users can add 20 accounts at most.</p> <p>Admin Password: enter the correct admin password before adding an account. User Level: Set the privilege for the account. User Name: Input user name for creating an account. Password: Input password for the account. Confirm: Confirm the password.</p> <p>You can edit and delete the account in the account list under the admin account. For the default admin account, you can only change the password, and it cannot be deleted.</p>

4.3.2 Logs

The logs contain the information about the time and IP that has accessed the web GUI.

Show entries

Time	Main Type	Sub Type	Param	User	IP	Detail	Log Search	
1969-12-31 18:06:37	Operation	Login Remotely	-	admin	192.168.1.101		Main Type:	<input type="text" value="All Types"/>
1969-12-31 18:06:30	Operation	Logout Remotely	-	admin	192.168.1.101		Sub Type:	<input type="text" value="All Types"/>
1969-12-31 18:06:12	Operation	Logout Remotely	-	admin	192.168.1.101		Start Time:	<input type="text" value="1969-12-31 00:00:00"/>
1969-12-31 18:03:52	Operation	Login Remotely	-	admin	192.168.1.101		End Time:	<input type="text" value="1969-12-31 23:59:59"/>
1969-12-31 18:03:42	Operation	Logout Remotely	-	admin	192.168.1.101		<input type="button" value="Search"/>	
1969-12-31 18:02:22	Operation	Config Remotely	Date&Time	admin	192.168.1.101		<input type="button" value="Log Export"/>	
1969-12-31 17:52:47	Operation	Login Remotely	-	admin	192.168.1.101		Save Period:	<input type="text" value="Permanent"/>
1969-12-31 17:52:35	Operation	Logout Remotely	-	youny2	192.168.1.101		<input type="button" value="Save"/>	
1969-12-31 17:52:14	Operation	Login Remotely	-	youny2	192.168.1.101			
1969-12-31	Operation	Logout Remotely	-	younv	192.168.1.101			

Showing 1 to 30 of 154 entries First Previous **1** 2 3 4 5 6 Next Last

Parameters	Description
Main Type	Select main log types
Sub Type	On the premise of main type has been selected, select the sub type to narrow the range of logs
Start Time	The time log starts
End Time	The time log ends
Log Export	Export the logs
Save Period	Set the period of log saving, there are eight options to choose: Permanent and 30/60/120/180/240/300/360 Days
Go	Input the number of logs' page

4.4 System

All information about the hardware and software can be checked on this page.

System	
Device Name:	<input type="text" value="Vision Sensor"/>
Product Model:	VS121-470M
Hardware Version:	V1.0
Software Version:	31.7.0.75-iot2-a9
MAC Address:	24:E1:24:F0:01:61

4.5 Maintenance

4.5.1 System Maintenance

Maintenance

System Maintenance Auto Reboot

System Upgrade

Software Version: 31.7.0.75-iot2-a6

Local Upgrade: No file chosen
 Reset after Upgrading

Online Upgrade:

Note: Do not disconnect the power of the device during the upgrade.

Maintenance

Reset Keep the IP Configuration Keep the User Information

Export Config File:

Config File: No file chosen

Import Config File:

Reboot

Reboot the Device:

Parameters	Description
System Upgrade	<p>Software Version: The software version of the sensor.</p> <p>Local Upgrade: Click the Choose File button and select the upgrading file, then click the Upgrade button to upgrade. After the system reboots successfully, the update is done.</p> <p>You can check Reset after Upgrading to reset the camera after upgrading it.</p> <p>Note: Do not disconnect the power of the device during the upgrade process. The device will be restarted to complete the upgrading.</p>
Maintenance	<p>Reset settings: Click Reset button to reset the sensor to factory default settings</p> <p>Keep the IP Configuration: Check this option to keep the IP configuration when resetting</p> <p>Keep the User information: Check this option to keep the user information when resetting</p> <p>Export Config File: Export configuration file.</p> <p>Import Config File: Click the Choose File button and select the configuration file, click Import button to import configuration file.</p>
Reboot	Restart the device immediately

4.5.2 Auto Reboot

Set the date and time to enable Auto Reboot function, the sensor will reboot automatically according to the customized time in case that sensor overload after running a long time. Before configuration note that the date and time should correct.

Auto Reboot Settings	
Enable Auto Reboot:	<input type="checkbox"/>
Day:	Everyday
Time:	00:00:00
Save	

5. Installation

Step 1: Ensure the thickness of ceiling is more than 30 mm, then attach the mounting sticker to the ceiling and drill 4 holes with a diameter of 6 mm.

Step 2: Fix the wall plugs into the ceiling holes.

Step 3: Remove the cover on the device, then fix the device to the wall plugs via mounting screws; remember to adjust the mounting direction according to the detection area requirement and direction sticker on the inner cover.

Step 4: Take the cover back to device; note that the Milesight Logo should be facing the LED indicator.

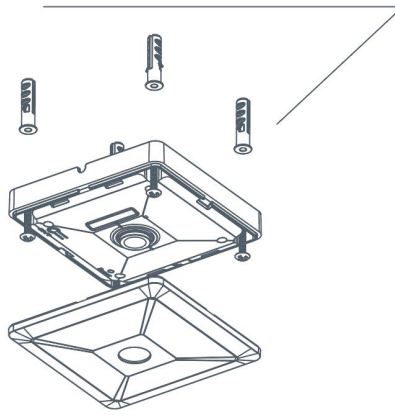

6. Device Payload

VS121 reports basic information only when joining the network and reports people counter according to reporting settings. All data are based on following format(HEX):

Channel1	Type1	Data1	Channel2	Type2	Data2	Channel 3	...
1 Byte	1 Byte	N Bytes	1 Byte	1 Byte	M Bytes	1 Byte	...

For decoder examples please find files on <https://github.com/Milesight-IoT/SensorDecoders>.

Channel	Type	Data Length/Byte	Description
ff	01(Protocol Version)	1	01=> V1
	08 (Device SN)	6	12 digits, on product label
	09 (Hardware Version)	2	01 04 => V1.4
	1f(Software Version)	4	1f 07 00 4b => V31.7.0.75
04	c9(People Counter)	4	Byte 1: total counter Byte 2: how many mapped region is customized Byte 3-4: indicate which mapped area has detected people, 0 means no people, 1 means there are people in this mapped area

Example:

ff 01 01 ff 08 66 00 b0 94 09 76 ff 09 01 00 ff 1f 1f 07 00 4b 04 c9 03 05 00 a1					
Channel	Type	Value	Channel	Type	Value
ff	01 (Protocol Version)	01 (V1)	ff	08 (Device SN)	66 00 b0 94 09 76
Channel	Type	Value	Channel	Type	Value
ff	09 (Hardware version)	0100 (V1.0)	ff	1f(Software version)	1f 07 00 4b (V31.7.0.75)
Channel	Type	Value			
04	c9(People Counter)	Byte 1: 03=> There are 3 people totally Byte 2: 05=> there are 5 mapped regions Byte 3-Byte 4: 00 a1=>1010 0001 there are people in region 1, 6 and 8			

-END-