



Wall Switch

Featuring LoRaWAN®

WS50x

User Guide



Safety Precautions

Milesight will not shoulder responsibility for any losses or damages resulting from not following the instructions of this operating guide.

- ❖ The installation and maintenance must be conducted by a qualified service person and should strictly comply with the electrical safety regulations of the local region.
- ❖ Ensure the breaker is power out during the installation.
- ❖ Do not leave any object inside the switch box when installation.
- ❖ The device must not be modified in any way.
- ❖ In order to protect the security of the device, please change the device password when first configuration. The default password is 123456.
- ❖ In order to realize the best data transmission, ensure the device is within the signal range of the LoRaWAN® gateway and keep it away from metal objects and obstacles.
- ❖ Do not overload the maximum capacity to avoid damaging the device.
- ❖ The device is intended for indoor use only. Do not place the device where the temperature is below/above the operating range.
- ❖ Do not place the device close to naked flames, heat source (such as oven or sunlight), cold source, liquid, and objects with extreme temperature changes.
- ❖ Use the device in a clean environment only. Dusty or dirty environments may prevent the proper operation of this device.
- ❖ The device must never be subjected to physical shocks or strong vibration.

Declaration of Conformity

WS50x is in conformity with the essential requirements and other relevant provisions of the CE, FCC, and RoHS.

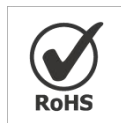

Copyright © 2011-2022 Milesight. All rights reserved.

All information in this guide is protected by copyright law. Whereby, no organization or individual shall copy or reproduce the whole or part of this user guide by any means without written authorization from Xiamen Milesight IoT Co., Ltd.

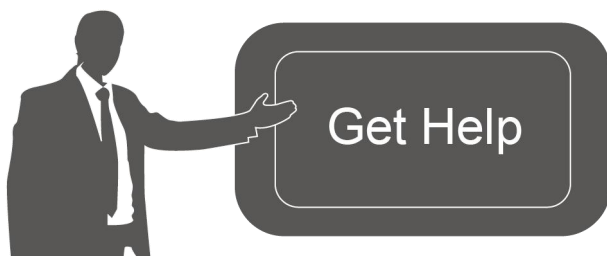

For assistance, please contact

Milesight technical support:

Email: iot.support@milesight.com

Tel: 86-592-5085280

Fax: 86-592-5023065

Address: Building C09, Software Park III,
Xiamen 361024, China

Revision History

Date	Doc Version	Description
June 24, 2022	V 1.0	Initial version

Contents

1. Product Introduction	5
1.1 Overview	5
1.2 Features	5
2. Hardware Introduction	5
2.1 Packing List	5
2.2 Hardware Overview	6
2.3 Dimensions (mm)	6
2.4 Wiring Diagram	7
3. Installation	7
4. Operation Guide	8
4.1 NFC Configuration	8
4.2 LoRaWAN Settings	9
4.2.1 Basic Settings	9
4.2.2 Frequency Settings	10
4.2.3 Multicast Settings	11
4.3 General Settings	14
4.4 LoRa D2D Settings	14
4.5 Maintenance	15
4.5.1 Upgrade	15
4.5.2 Backup	16
4.5.3 Reset to Factory Default	17
5. Device Payload	18
5.1 Basic Information	18
5.2 Sensor Data	18
5.3 Downlink Commands	19

1. Product Introduction

1.1 Overview

WS50x is a smart LoRaWAN® wall switch for the local and remote control of lights and electrical appliances. It adopts two standard sizes for most of international wall switch types, which can replace the traditional wall switches directly. Compliant with Milesight LoRaWAN® gateway and Milesight IoT Cloud solution, WS50x can be monitored and controlled via web page or mobile App remotely and triggered by other Milesight sensors. Besides LoRaWAN®, WS50x supports Milesight LoRa D2D communication protocol, which can set up connection quickly and be controlled without gateway. WS50x can be widely used for wireless control of indoor lights, fans, heaters, machines, etc.

1.2 Features

- Support local or remote control via a relay with high reliability
- Support surge protection, and overload protection to prevent the device from damage
- Collect data of current, voltage, power, and electrical consumption
- Built-in switch indicator for easy use in dark environment
- Up to 15 km communication range
- Easy configuration via NFC
- Standard LoRaWAN® technology
- Compatible with Milesight IoT Cloud
- Support Milesight LoRa D2D protocol to enable ultra-low latency control without gateway
- Support multicast for control in bulk

2. Hardware Introduction

2.1 Packing List

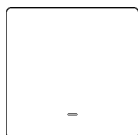

1 × WS50x Wall
Switch

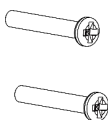

2 × Mounting Screws



1 x Quick Start Guide



1 x Warranty Card



If any of the above items is missing or damaged, please contact your sales representative.

2.2 Hardware Overview

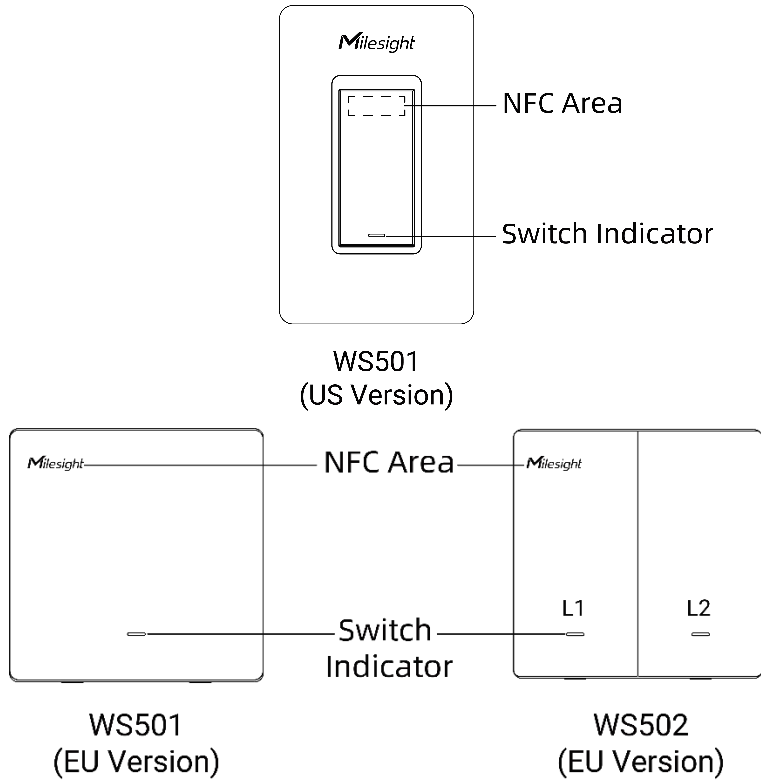

2.3 Dimensions (mm)

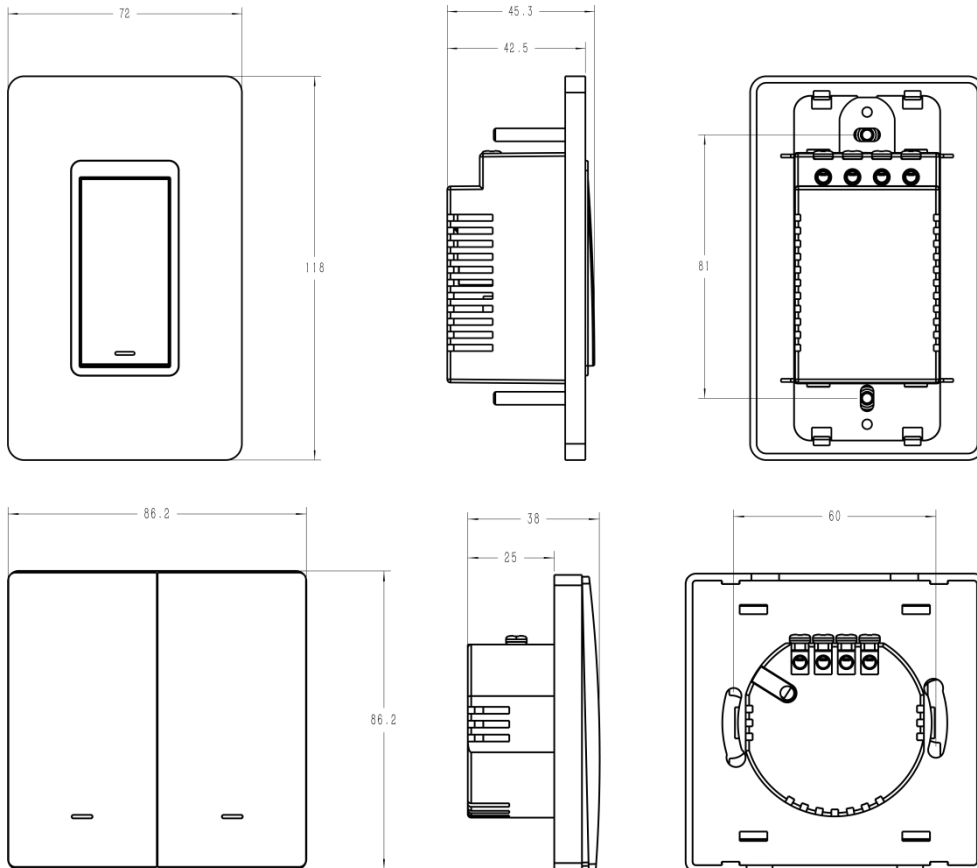

2.4 Wiring Diagram

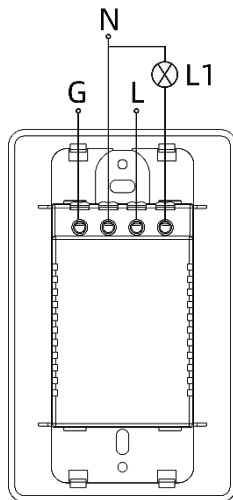

WS501
(3W-W12-US)

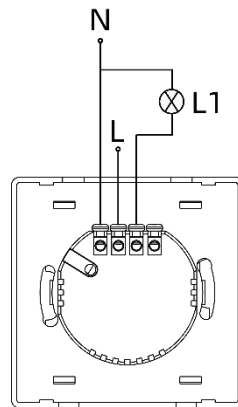

WS501
(3W-W11-EU)

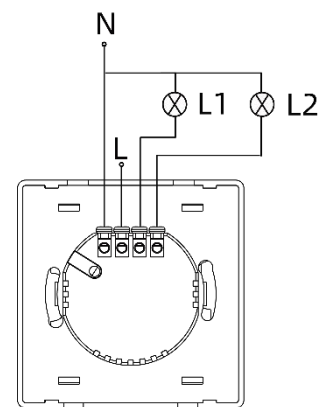

WS502
(3W-W11-EU)

3. Installation

1. Ensure the circuit has been shut off and the old switch has been taken off.
2. Open the front panel of WS50x switch.

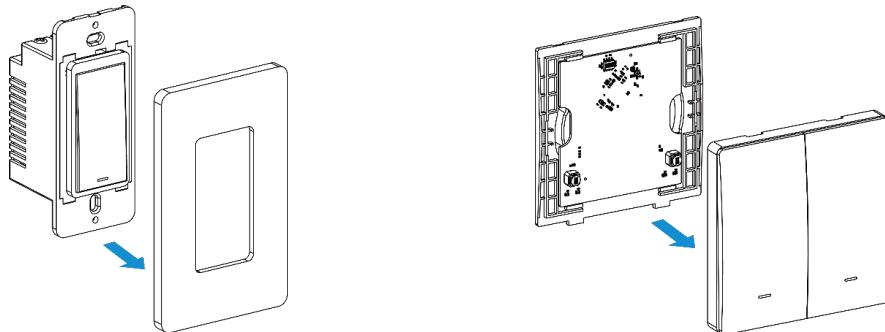

3. Connect corresponding wires to the WS50x switch.

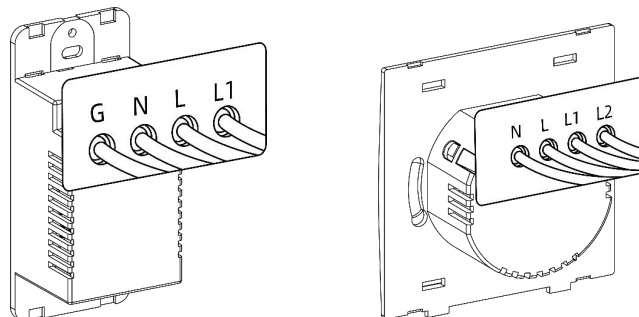

4. Fix the WS50x switch to the switch box with mounting screws, then fix the front panel back to the device.

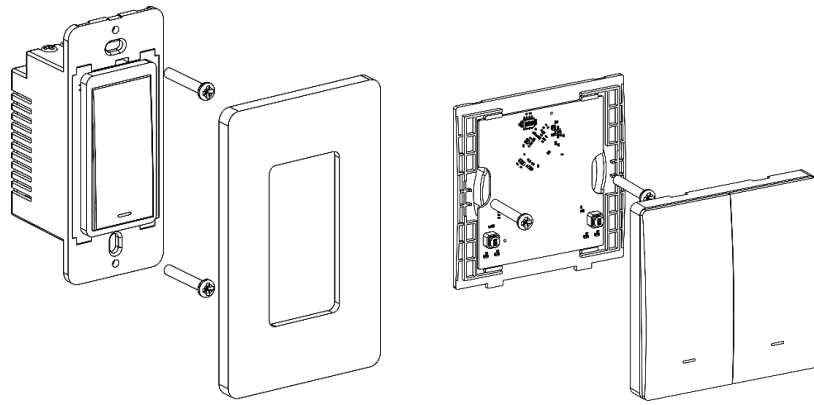

4. Operation Guide

4.1 NFC Configuration

WS50x can be configured via an NFC supported mobile phone.

1. Download and install “Milesight ToolBox” App from Google Play or Apple App Store.
2. Enable NFC on the smartphone and open Milesight ToolBox.
3. Attach the smartphone to NFC area of the switch to read device information.

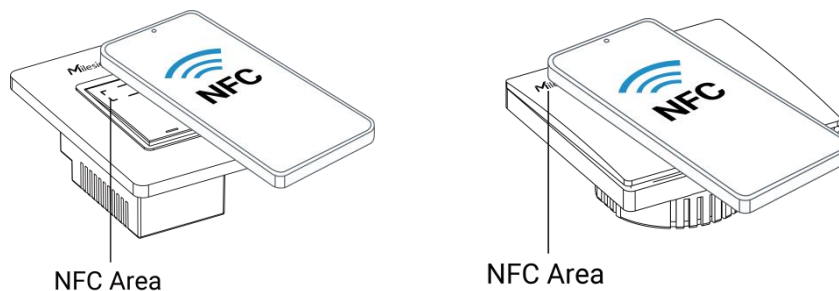

4. Basic information and settings of WS50x switch will be shown on the ToolBox if it's recognized successfully. You can read and configure the device by tapping the Read/Write button on the App. In order to protect the security of devices, password validation is required when first configuration. The default password is **123456**.

Note:

- 1) Ensure where is the NFC area on your smartphone, and it's recommended to take off the phone case.
- 2) If the smartphone fails to read/write configurations via NFC, keep the phone away and back to try again.
- 3) WS50x can also be configured by ToolBox software via a dedicated NFC reader provided by Milesight IoT.

4.2 LoRaWAN Settings

LoRaWAN settings are used to configure the data transmission parameters in the LoRaWAN® network.

4.2.1 Basic Settings

WS50x supports basic configurations like join type, App EUI, App Key and other information. You can also keep all settings unchanged by default.

Device EUI	24E124
App EUI	24E124C0002A0001
Application Port	85
Working Mode:	Class C
Join Type	OTAA
Application Key	*****
RX2 Data Rate	DR0 (SF12, 125 kHz)
RX2 Frequency	923300000
Spread Factor	? SF7-DR3
Confirmed Mode	? <input type="checkbox"/>
Rejoin Mode	? <input checked="" type="checkbox"/>
Set the number of packets sent	32 packets
ADR Mode	? <input checked="" type="checkbox"/>
TXPower	TXPower0-22 dBm

Parameters	Description
Device EUI	Unique ID of the device which can also be found on the label.
App EUI	Default App EUI is 24E124C0002A0001.
Application Port	The port used for sending and receiving data, the default port is 85.
Join Type	OTAA and ABP modes are both available.
Application Key	Appkey for OTAA mode is default as 5572404C696E6B4C6F52613230313823.
Device Address	DevAddr for ABP mode is default as the 5 th to 12 th digits of SN.
Network Session Key	Nwkskey for ABP mode is default as 5572404C696E6B4C6F52613230313823.

Application	Appskey for ABP mode is default as
Session Key	5572404C696E6B4C6F52613230313823.
LoRaWAN Version	V1.0.2 and V1.1.0 are available.
Work Mode	This device supports Class C only.
RX2 Data Rate	RX2 data rate to receive downlinks or LoRa D2D commands.
RX2 Frequency/MHz	RX2 frequency to receive downlinks or LoRa D2D commands.
Confirmed Mode	If the device does not receive ACK packet from network server, it will resend data once.
Rejoin Mode	The device will send a specific number of LinkCheckReq MAC packets to the network server every 30 mins to validate connectivity; If there is no response, the device will re-join the network.
ADR Mode	Allow the network server to adjust the data transmission rate of the device.
Spread Factor	If ADR is disabled, the device will send data via this spread factor.
Tx Power	Transmit power of the device.

Note:

- 1) Please contact sales representative for device EUI list if there are many units.
- 2) Please contact sales representative if you need random App keys before purchase.
- 3) Select OTAA mode if you use Milesight IoT Cloud to manage devices.
- 4) Only OTAA mode supports rejoin mode.

4.2.2 Frequency Settings

Select supported frequency and channels to send uplinks. Make sure the channels match the LoRaWAN® gateway.

* Support Frequency

EU868 ▼

<input checked="" type="checkbox"/>	-	868.1	+
<input checked="" type="checkbox"/>	-	868.3	+
<input checked="" type="checkbox"/>	-	868.5	+
<input type="checkbox"/>	-	863	+
<input type="checkbox"/>	-	863	+

If device frequency is one of CN470/AU915/US915, you can enter the index of the channel that you want to enable in the input box, making them separated by commas.

Examples:

1, 40: Enabling Channel 1 and Channel 40

1-40: Enabling Channel 1 to Channel 40

1-40, 60: Enabling Channel 1 to Channel 40 and Channel 60

All: Enabling all channels

Null: Indicates that all channels are disabled

* Support Frequency

US915

Enable Channel Index ⓘ

0-71

Index	Frequency/MHz ⓘ
0 - 15	902.3 - 905.3
16 - 31	905.5 - 908.5
32 - 47	908.7 - 911.7
48 - 63	911.9 - 914.9
64 - 71	903 - 914.2

Note:

For -868M model, the default frequency is EU868;

For -915M model, the default frequency is AU915.

4.2.3 Multicast Settings

WS50x supports setting up several multicast groups to receive multicast commands from the network server, then users can use this feature to control devices in bulks.

1. Enable Multicast Group on WS50x, and set a unique multicast address and keys to distinguish other groups. You can also keep these settings by default.

Multicast Group1

Multicast Address (i)

McNetSKey

McAppSKey

Multicast Group2

Multicast Group3

Multicast Group4

Parameters	Description
Multicast Address	Unique 8-digit address to distinguish different multicast groups.
Multicast McNetSkey	32-digit key. Default values: Multicast Group 1: 5572404C696E6B4C6F52613230313823 Multicast Group 2: 5572404C696E6B4C6F52613230313824 Multicast Group 3: 5572404C696E6B4C6F52613230313825 Multicast Group 4: 5572404C696E6B4C6F52613230313826
Multicast McAppSkey	32-digit key. Default values: Multicast Group 1: 5572404C696E6B4C6F52613230313823 Multicast Group 2: 5572404C696E6B4C6F52613230313824 Multicast Group 3: 5572404C696E6B4C6F52613230313825 Multicast Group 4: 5572404C696E6B4C6F52613230313826

2. Add a multicast group on the network server. Take Milesight UG6x gateway as example, go to **“Network Server -> Multicast Groups”**, click **“Add”** to add a multicast group.

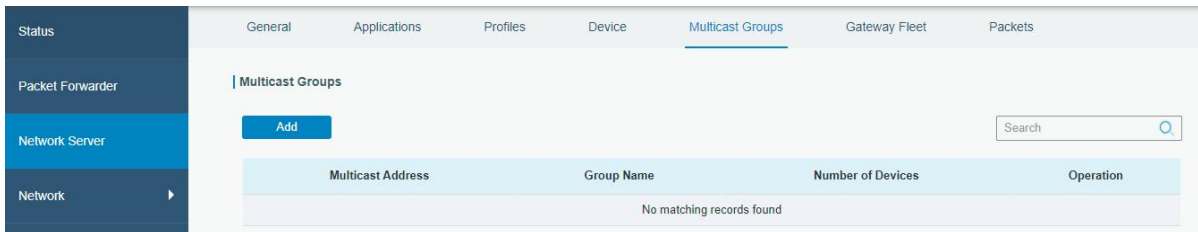

Fill in the multicast group information the same as WS50x settings, and select the devices which you need to control, then click **“Save”**.

Group Name: Light Control

Multicast Address: 11111111

Multicast Network Session Key: 5572404C696E6B4C6F526132

Multicast Application Session Key: 5572404C696E6B4C6F526132

Class Type: Class C

Datarate: DR0 (SF12, 125 kHz)

Frequency: 869525000 Hz

Frame-counter: 0

Selected Devices:

- 10_24E124136B261600
- 24E124122A233246

General Applications Profiles Device **Multicast Groups** Gateway Fleet Packets

Multicast Groups

Add

Multicast Address	Group Name	Number of Devices	Operation
11111111	Light Control	2	

3. Go to **“Network Server -> Packets”**, select the multicast group and fill in the downlink command, click **“Send”**. The network server will broadcast the command to devices that belong to this multicast group.

Note: ensure all devices’ application ports are the same.

General Applications Profiles Device Multicast Groups Gateway Fleet **Packets**

Send Data To Device

Device EUI	Type	Payload	Port	Confirmed	Send
<input type="text" value="0000000000000000"/>	ASCII	<input type="text"/>	85	<input type="checkbox"/>	<input type="button" value="Send"/>

Send Data to Multicast Group

Multicast Group	Type	Payload	Port	Send
Light Control	hex	0810ff	85	<input type="button" value="Send"/>

4.3 General Settings

Reporting Interval min

LED Indicator

Power Consumption ⓘ

When Power is Restored

Button Lock

Change Password

Parameters	Description
Reporting Interval	The interval of reporting switch status and electrical parameters. Default: 20 mins, Range: 1 - 1080 mins
LED Indicator	Enable or disable the light of switch button. This will not affect the blinks when you hold on switch buttons to reset the device.
Power Consumption	Record the power consumption. If disabled, the device will stop recording and the power consumption value will stop updating.
When Power is Restored	If the device is powered off and restored, the device will change according to this parameter.
Button Lock	If enabled, all switch buttons will not be allowed to turn on/off or reset to factory default.
Change Password	Change the password for ToolBox App to write this device.

4.4 LoRa D2D Settings

LoRa D2D protocol is developed by Milesight and used for connection among Milesight devices without gateway. When LoRa D2D setting is enabled, WS50x can work as the LoRa D2D agent device to receive commands from LoRa D2D controller devices.

1. Ensure the RX2 datarate and RX2 frequency in LoRaWAN settings are the same as the LoRa D2D controller device.
2. Enable LoRa D2D feature, and define a unique LoRa D2D key to be the same as the setting in LoRa D2D controller device.
(Default LoRa D2D Key: 5572404C696E6B4C6F52613230313823)
3. Define a 2-byte hexadecimal control command (0x0000 to 0xffff) and command action. For example, you can configure a control command 12ff to turn on any button as below. WS50x supports at most 16 control commands.

LoRa D2D Settings ^

Enable

LoRa D2D Key

1

2

Control command 1

Action Object

▼

+

Status

Off▼

4. These control commands can be configured in LoRa D2D controller device. When LoRa D2D controller device is triggered, it will send the pre-defined control commands to control the switches of WS50x to on, off or inverse status.

4.5 Maintenance

4.5.1 Upgrade

1. Download firmware from www.milesight-iot.com to your smartphone.
2. Open ToolBox App and click "Browse" to import firmware and upgrade the device.

Note:

- 1) Operation on ToolBox is not supported during the upgrade.
- 2) Only Android version ToolBox supports the upgrade feature.

WS502-915M

Status Setting Maintenance

SN 6771C21070911328

Model WS502-915M

Firmware Version V1.1

Hardware Version V1.0

Manual Upgrade

Browse



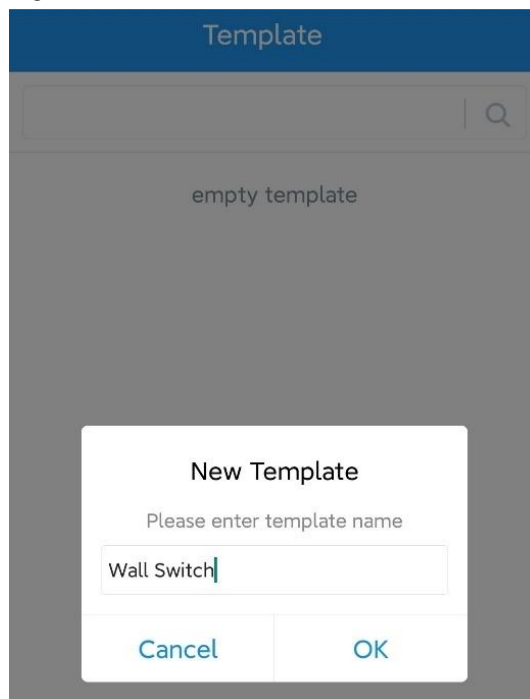

4.5.2 Backup

WS50x supports configuration backup for easy and quick device configuration in bulk. Backup is allowed only for devices with the same model and LoRaWAN® frequency band.

1. Go to “Template” page on the App and save current settings as a template. You can also edit the template file.
2. Select one template file that saved in the smartphone and click “Write”, then attach it to another device to write configuration.



Note: Slide the template item to the left to edit or delete it. Click the template to edit the configurations.

Template	
<input type="text"/>	<input type="text"/>
 EM500-UDL-868M_20201124 Last Modified Time: 2020-11-24 17:06:26	
 EM300-TH-915M_20210112 Last Modified Time: 2021-01-12 14:35:12	
 UC512-DI-868M_20210128 Last Modified Time: 2021-01-28 16:57:20	
 UC501-470M_20210201 Last Modified Time: 2021-02-01 11:29:43	
 M_20210208 Last Modified Time: 2021-02-08 16:44:37	Edit Delete

4.5.3 Reset to Factory Default

Please select one of the following methods to reset the device:

Via Hardware: Hold on the button for more than 10s until button light blinks, this should ensure the button lock is disabled.

Via ToolBox App: Go to **Device -> Maintenance** to tap "Reset", then attach smartphone with NFC area to the device to complete the reset.

WS502-915M		
Status	Setting	Maintenance
SN	6771C21070911328	
Model	WS502-915M	
Firmware Version	V1.1	
Hardware Version	V1.0	
Manual Upgrade		
Browse		
Restore Factory Default		
Reset		
Reboot		

5. Device Payload

All data are based on the following format (HEX), the Data field should follow little -endian:

Channel1	Type1	Data1	Channel2	Type2	Data2	Channel 3	...
1 Byte	1 Byte	N Bytes	1 Byte	1 Byte	M Bytes	1 Byte	...

For decoder examples you can find at <https://github.com/Milesight-IoT/SensorDecoders>.

5.1 Basic Information

WS50x reports basic information of the device whenever it joins the network.

Channel	Type	Description
ff	01(Protocol Version)	11=>V1.1
	09 (Hardware Version)	01 40 => V1.4
	0a (Software Version)	01 14 => V1.14
	0b (Power On)	Device is on
	16 (Serial Number)	Serial number of this device, 16 digits

Example:

ff0bff ff0101 ff090100 ff0a0101 ff166771c21070911328					
Channel	Type	Value	Channel	Type	Value
ff	0b (Power On)	ff (Reserved)	ff	01 (Protocol Version)	01(V1.0)
Channel	Type	Value	Channel	Type	Value
ff	09 (Hardware Version)	0100 (V1.0)	ff	0a (Software Version)	0101 (V1.1)
Channel	Type	Value			
ff	16 (Serial Number)	6771c21070 911328			

5.2 Sensor Data

WS50x reports switch status and electrical data according to reporting interval (20 mins by default). Besides, when any switch status changes, the device will upload the switch status immediately.

Channel	Type	Description
03	74 (Voltage)	UINT16, Unit: V Resolution: 0.1 V
04	80 (Active Power)	UINT32, Unit: W
05	81 (Power Factor)	UINT8, Unit: %

06	83 (Power Consumption)	UINT32, Unit: Wh
07	c9 (Total Current)	UINT16, Unit: mA
08	29 (Switch Status)	Bit 0: status of switch 1 Bit 1: status of switch 2 Bit 2: status of switch 3 Bit 3: reserved Bit 4: changing status of switch 1 Bit 5: changing status of switch 2 Bit 6: changing status of switch 3 Bit 7: reserved

Example:

082913 058164 07c90200 0374b208 068301000000 048001000000					
Channel	Type	Value	Channel	Type	Value
08	29 (Switch Status)	13= 00010011 => switch 1 changed to open, switch 2 remains opened	05	81 (Power Factor)	64=> 100%
Channel	Type	Value	Channel	Type	Value
07	c9 (Current)	02 00=>00 02=2mA	03	74(Voltage)	b2 08=>08 b2=2226 Voltage=2226 *0.1=222.6V
Channel	Type	Value	Channel	Type	Value
06	83(Power Consumption)	01 00 00 00=>00 00 00 01=1 Wh=0.001 kWh	04	80 (Active Power)	01 00 00 00=>00 00 00 01=1 W

5.3 Downlink Commands

WS50x supports downlink commands to configure the device. The application port is 85 by default.

Channel	Type	Description
08	-	Byte 1: Bit 0~3: every switch control status, 0 for close, 1 for open. Bit 4~7: every switch change status, 0 = not

		allow control, 1 = allow control Byte 2: ff
ff	03 (Set Reporting Interval)	2 Bytes, unit: s
	10 (Reboot Device)	ff
	22 (Add Delay Task)	Byte 1: 00 Byte 2-3: delay time, unit: s Byte 4: Bit 0~3: desired status for each switch. Bit 4~7: mask of switches to change, only masked switch will be changed to desired status. Note: WS50x supports adding only one task. Later command will cover previous command.
	23 (Delete Delay Task)	00 ff
	25 (Set Button On/Off Lock)	0080-disable to turn on/off via button, 0000-enable to turn on/off via button
	26 (Power Consumption)	00-disable, 01-enable
	27 (Reset Power Consumption)	ff
	28 (Enquire Electrical Status)	ff
	2f (Set Button Light Mode)	00-disable 01-enable (Button light indicator on when switch button is off) 02-enable (Button light indicator on when switch button is on)
	5e (Set Button Reset Lock)	00-enable to reset via button, 01-disable to reset via button

Example:

1. Close Switch 1 of WS501, WS502, WS503.

0810ff		
Channel	Type	Command
08	-	Byte 1: 10 => 0001 0000 (Bit 4 = 1 => Allow switch 1 control, Bit0 = 0 => Switch 1 close) Byte 2: ff is reserved

2. Set reporting interval as 20 minutes.

ff03b004		
Channel	Type	Value
ff	03 (Set Reporting Interval)	b0 04 => 04 b0 = 1200 s = 20 minutes

3. Add a delay task: open switch 1 after 1 minute.

ff32003c002000		
Channel	Type	Value
ff	22 (Add Delay Task)	Byte 1: 00 Byte 2-3: 3c 00 => 00 3c = 60 s = 1 min Byte 4: 11 = 0001 0001 => Open switch 1

4. Delete the delay task

ff2300ff		
Channel	Type	Value
ff	23 (Delete Delay Task)	00ff

5. Disable the collection and upload of power consumption.

ff2600		
Channel	Type	Value
ff	26 (Power Consumption)	00 = disable

6. Reboot the device.

ff10ff		
Channel	Type	Value
ff	10 (Reboot Device)	ff (Reserved)

7. Disable button light.

ff2f00		
Channel	Type	Value
ff	2f (Set LED Indicator Mode)	00 for disable LED indicator

-END-