



Ultra ToF People Counter

VS135-L08EU

User Guide



Safety Precautions

Milesight will not shoulder responsibility for any loss or damage resulting from not following the instructions of this operating guide.

- ❖ Though the device is compliant with Class 1 (IEC/EN 60825-1:2014), please **DO NOT** look at the ToF sensor too close and directly.
- ❖ The device must not be disassembled or remodeled in any way.
- ❖ To avoid risk of fire and electric shock, do keep the product away from rain and moisture before installation.
- ❖ Do not place the device where the temperature is below/above the operating range.
- ❖ **Do not touch the device directly to avoid the scalds when the device is running.**
- ❖ The device must never be subjected to shocks or impacts.
- ❖ Make sure the device is firmly fixed when installing.
- ❖ Do not expose the device to where laser beam equipment is used.
- ❖ Use a soft, dry cloth to clean the lens of the device.

Declaration of Conformity

VS135 is in conformity with the essential requirements and other relevant provisions of the CE, FCC, and RoHS.

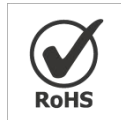

Copyright © 2011-2024 Milesight. All rights reserved.

All information in this guide is protected by copyright law. Whereby, no organization or individual shall copy or reproduce the whole or part of this user guide by any means without written authorization from Xiamen Milesight IoT Co., Ltd.

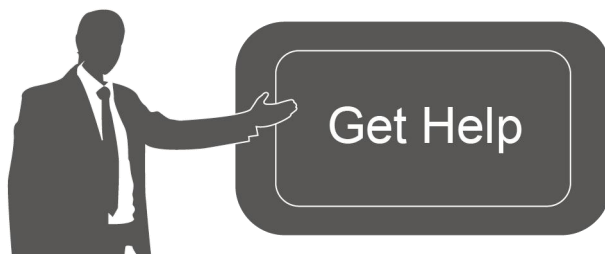

For assistance, please contact

Milesight technical support:

Email: iot.support@milesight.com

Support Portal: support.milesight-iot.com

Tel: 86-592-5085280

Fax: 86-592-5023065

Address: Building C09, Software Park
Phase III, Xiamen 361024,
China

Revision History

Date	Doc Version	Description
Feb. 23, 2024	V 1.0	Initial version

Contents

1. Product Introduction	5
1.1 Overview	5
1.2 Key Features	5
2. Hardware Introduction	6
2.1 Packing List	6
2.2 Hardware Overview	6
2.3 Button Descriptions	6
2.4 Dimensions (mm)	7
2.5 SIM Card Installation	7
3. Power Supply	7
4. Access the Sensor	8
5. Operation Guide	9
5.1 Dashboard	9
5.2 Rule	11
5.3 Communication	15
5.3.1 Network Configuration	15
5.3.2 Recipient & API	18
5.4 Report	22
5.5 Validation	23
5.6 System	24
5.6.1 Device Info	24
5.6.2 User	25
5.6.3 Time Configuration	27
5.6.4 Remote Management	27
5.6.5 System Maintenance	28
6. Installation Instruction	29
6.1 Installation Height	29
6.2 Covered Detection Area	30
6.3 Environment Requirements	31
6.4 Installation	32
6.5 Factors Affecting Accuracy	35
7. Communication Protocol	35
7.1 Line Crossing People Counting-Periodic Report	35
7.2 Line Crossing People Counting-Trigger Report	37
7.3 Region People Counting - Periodic Report	39
7.4 Region People Counting - Trigger Report	41

1. Product Introduction

1.1 Overview

VS135 is a high-end people counting sensor that is based on deep learning AI and second-generation ToF technology. It is capable of adapting to various complex scenarios while ensuring excellent privacy protection. This sensor possesses an impressive accuracy of up to 99.8% in people counting, fully meeting your needs, and it delivers exceptional performance for both indoor and outdoor applications. With high ceiling mounting of up to 6.5m and an IP65 waterproof rating, it adapts seamlessly to any environment.

1.2 Key Features

- Up to 99.8% accuracy with the 2nd generation ToF technology and AI algorithm.
- Allow to collect more accurate people counting data by differentiating children / adults and detecting staffs via identification like staff lanyards for clearer people analysis.
- Smart U-turn detection to filter redundant counting of people wandering in the area.
- Support queuing management via dwell time detection and regional people counting.
- Support Group Counting function to gain deeper insights into customers' behaviors.
- Support advanced Heat Map function which provides deeper insights by visually representing the distribution and intensity of foot traffic.
- With radar sensor based ESG friendly working mode, it allows to experience full-speed operation when occupied while switching to a power-saving sleep mode when unoccupied.
- By incorporating 3-axis sensors for automatic height calibration, it ensures enhanced precision and guarantees accurate data analysis.
- Support automatic compensation of person height values when the device is mounted at a tilt.
- Working well even in low-light or completely dark environments with great lighting adaptability
- Free from privacy concerns without image capturing.
- Automatically detect the optimal installation height, facilitating fast deployment and intelligent detection.
- Support video validation function to help customers verify statistical accuracy.
- High compatibility of data transmission(HTTP/MQTT).
- Support local data storage and data retransmission to collect data securely.
- Quick and easy management with Milesight DeviceHub.

2. Hardware Introduction

2.1 Packing List

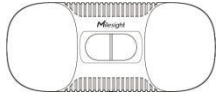

1 × VS135 Device



4 × Ceiling Mounting Kits



8 × Staff Tags

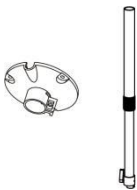

1 × VB01 Multifunctional Bracket Kit (Optional)

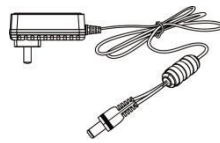

1 × Power Adapter



1 × Quick Guide



1 × Warranty Card

! If any of the above items is missing or damaged, please contact your sales representative.

2.2 Hardware Overview

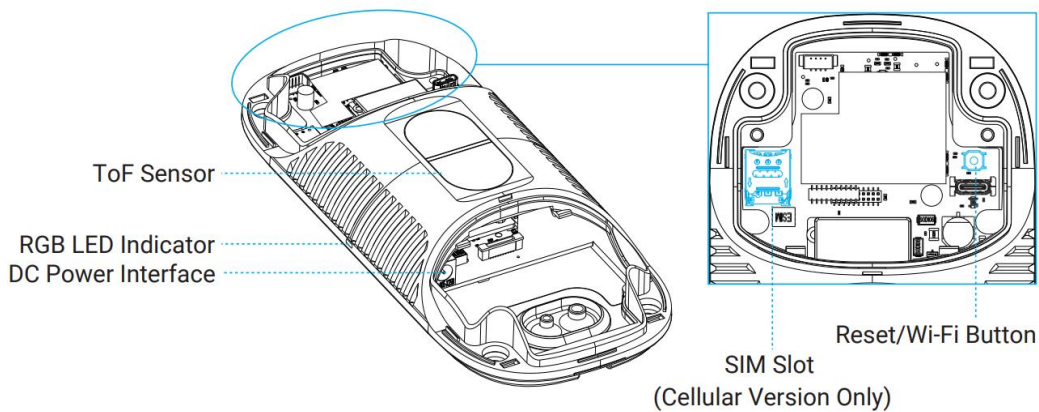

2.3 Button Descriptions

Function	Action	LED Indication
----------	--------	----------------

Turn On/Off Wi-Fi	Press and hold the power button for more than 3 seconds.	Turn On/Off: Blue light blinks for 3 seconds. Wi-Fi On: Blue light on. Wi-Fi Off: Green light on.
Reset to Factory Default	Press and hold the reset button for more than 10 seconds.	Green light blinks until the reset process is completed.

2.4 Dimensions (mm)

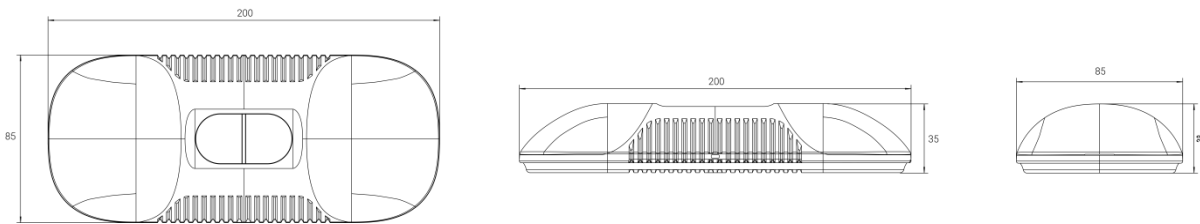

2.5 SIM Card Installation

Step 1: Take down the side covers.

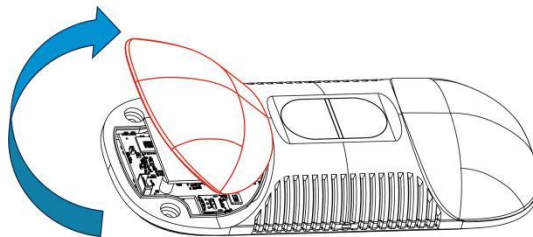

Step 2: Open the slot cover, insert SIM card (3FF).

Step 3: Restore slot cover back.

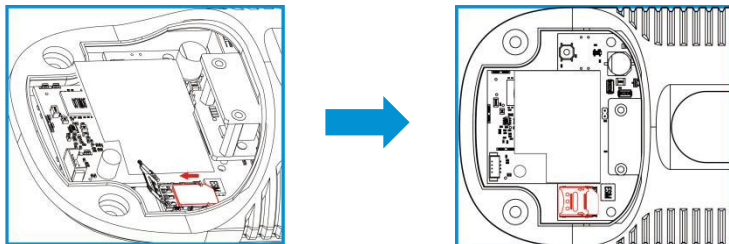

3. Power Supply

- Powered by DC Power Adapter (12V, 2A)

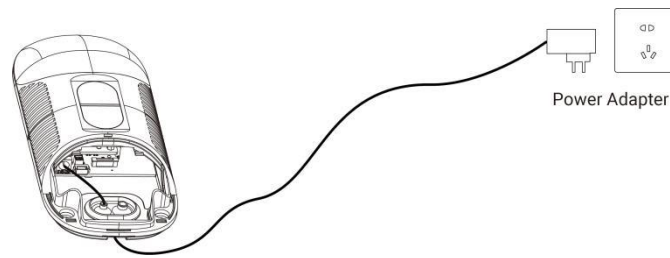

4. Access the Sensor

VS135 provides user-friendly web GUI for configuration access via Wi-Fi. Users need to customize the password when using the device for the first time. The default settings are as below:

Wi-Fi SSID: People Counter_xxxxxx (can be found on the device label)

Wi-Fi IP: 192.168.1.1

Here are the wireless method way of accessing the web GUI:

Step 1: Enable the Wireless Network Connection on your computer, search for corresponding Wi-Fi SSID to connect it, then type 192.168.1.1 to access the web GUI.

Step 2: Select the language.

Step 3: Users need to set the password and three security questions when using the sensor for the first time (three questions can be skipped by refreshing webpage). After configuration, log in with username (admin) and custom password.

Note:

- 1) Password must be 8 to 16 characters long, which contains at least two kinds or more in combination with numbers, lowercase letters, uppercase letters and special characters.
- 2) You can click the "forgot password" in login page to reset the password by answering three security questions when you forget the password if you set the security questions in advance.

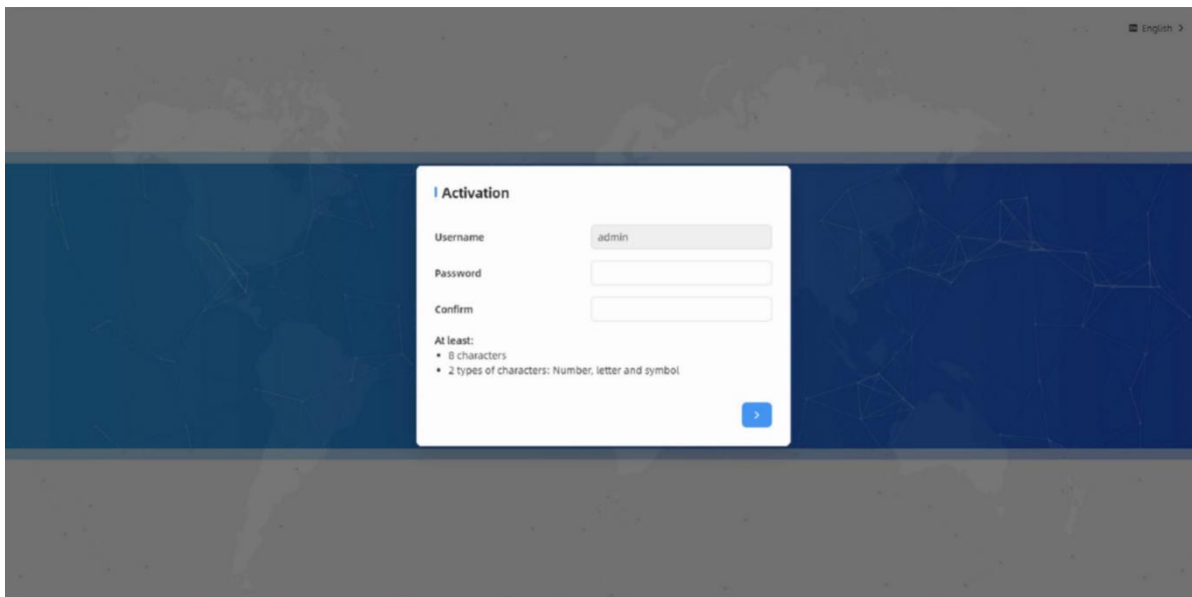

English >

Activation

Username:

Password:

Confirm:

At least:

- 8 characters
- 2 types of characters: Number, letter and symbol

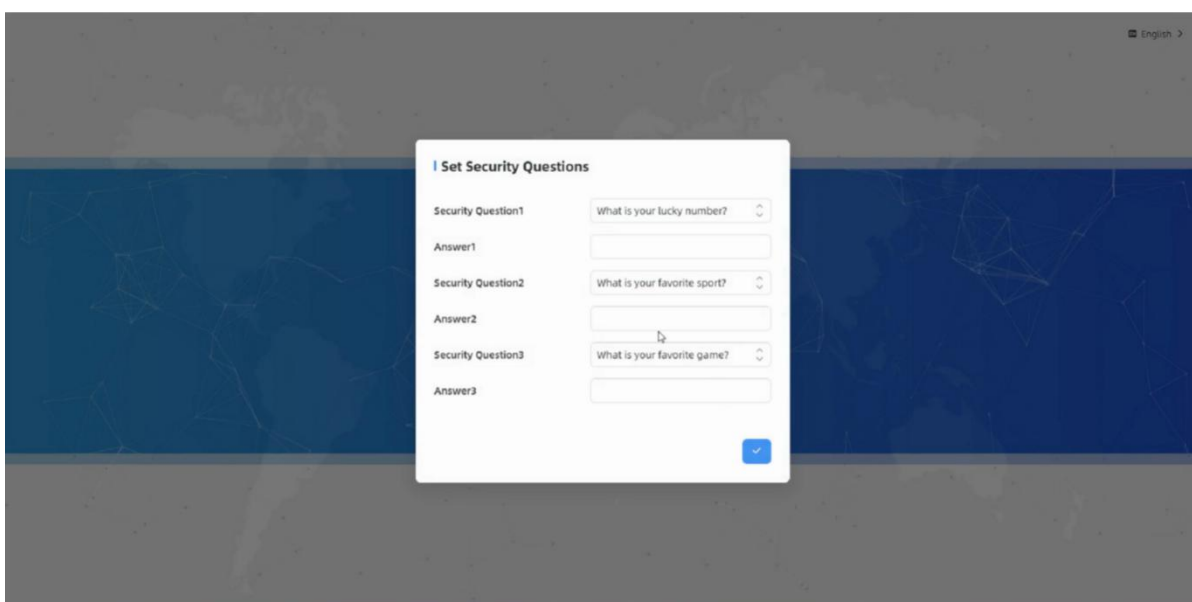

English >

Set Security Questions

Security Question1:

Answer1:

Security Question2:

Answer2:

Security Question3:

Answer3:

5. Operation Guide

5.1 Dashboard

After logging on to the device web GUI successfully, user is allowed to view live video as following.

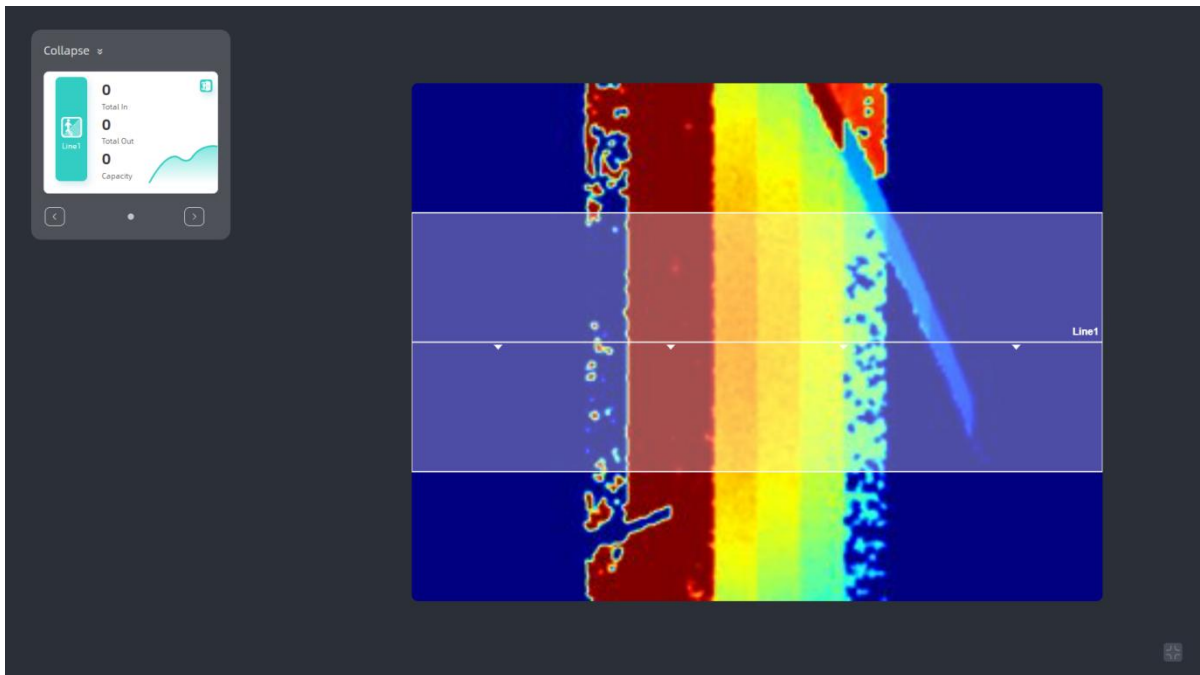
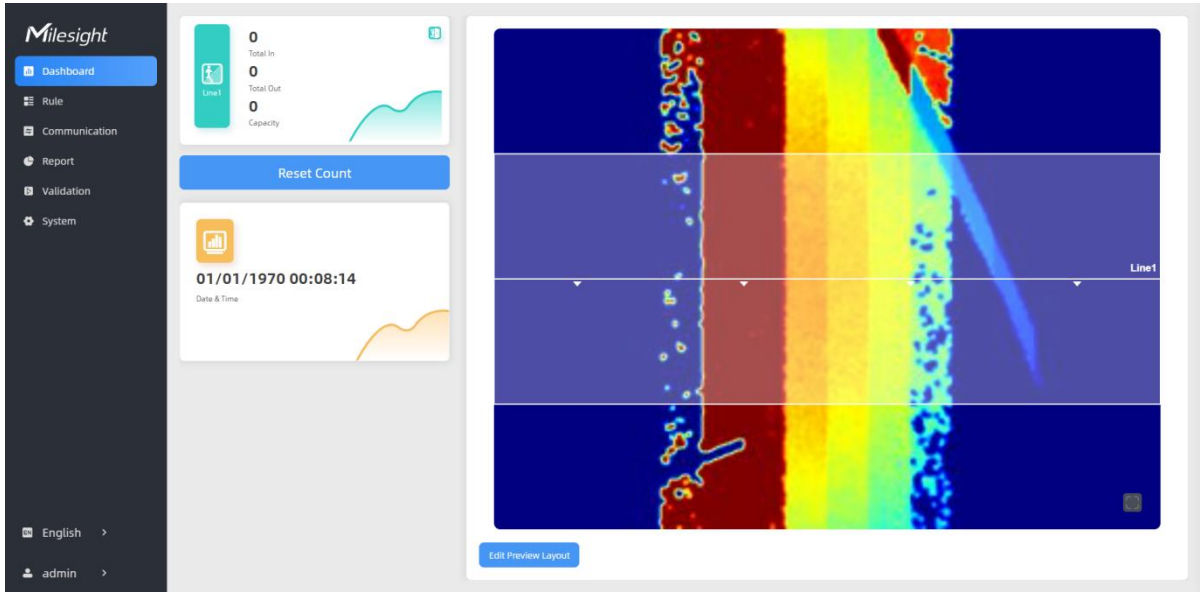

Parameters	Description
	<p>Hide Capacity: Hide the total count data capacity;</p> <p>Staff Excluded: Exclude staff data from statistical data;</p> <p>Children Excluded: Exclude children data from statistical data.</p>
Reset Count	Clear all accumulated entrance and exit people counting values.
Digital Output	Click to output a 5s high level signal from alarm out interface. Alarm Output: dry contact, output=two contacts closure
Edit Preview Layout	Click to edit the preview layout. Step 1: Select video stream preview, static image preview or no image preview as needed. Step 2: Click to show tracking lines, detection lines, U-turn areas and

detection regions as needed.

Edit Preview Layout

Scene Preview Video Stream Static Images No Image

Show Tracking Lines

Show Detection Lines

Show U-turn Areas

Show Detection Regions

× ✓

5.2 Rule

Basic Counting Settings

Users can draw detection lines to record the people count values which indicate the number of people enter or exit.

Step 1: Click **Draw Detection Lines**.

Step 2: Left-click to start drawing and drag the mouse to draw a line, left-click again to continue drawing a different direction edge, and right-click the mouse to complete the drawing. The line can be dragged to adjust the location and length. One device supports at most 4 broken lines with maximum 4 segments each.

Step3: If users need to delete the line, click **Draw Detection Lines** and select the line which need to be deleted, then click **Clear This Line** or click **Clear All**.

The screenshot displays the Milesight software interface. On the left is a navigation menu with options: Dashboard, Rule (selected), Communication, Report, Validation, and System. Below the menu are language and user settings: English and admin. The main area is split into two panels. The left panel shows a heatmap with two vertical detection lines, Line1 and Line2, and a 'Draw Detection Lines' button. The right panel contains configuration options:

- Deployment Parameters:** Installation Height (3000 mm), Max. Target Height (2000 mm), Min. Target Height (1000 mm).
- Counting Strategy:** Tracking Mode (Heads Tracking selected), Line Cross Counting (checked).
- Table:**

No.	Line Name	Operation
No.1	Line1	⊗
No.2	Line2	⊗
No.3	Line3	⊗
- U-turn Filtering:** (checked)
- Draw U-turn Areas:** (Draw button)
- Children Distinction:** (unchecked)
- Staff Detection:** (unchecked)

Note:

- 1) The arrow direction of the detection line depends on your drawing direction. If users need to flip the line, select the line which need to be flipped and click Flip Arrow Direction. And users can click Flip All to flip all detection lines.

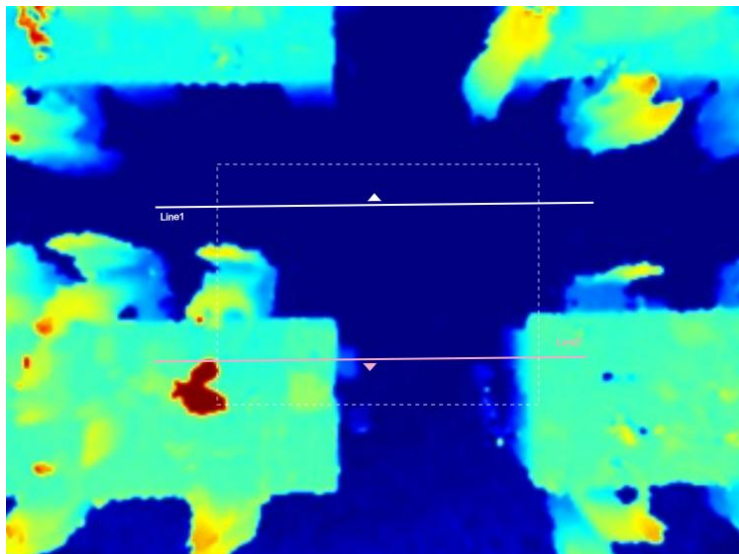

- 2) Ensure that the detected target can pass through the detection line completely. It's recommended that the detection line is perpendicular to the In/Out direction and on the center of the detection area without other objects around.
- 3) Redundant identification spaces are needed on both sides of the detection line for the target detection. It ensures the stable recognition and tracking of the target before passing the detection line, which will make the detection and count more accurate.

Rule Configuration

Users can set the rules to ensure accurate counting.

Deployment Parameters

Installation Height
mm(2000~3500) Detect

Max. Target Height
mm(500~3000)

Min. Target Height
mm(500~3000)

× ✓

Counting Strategy**Tracking Mode** ⓘHeads TrackingFeet Tracking**Line Cross Counting**

No.	Line Name	Operation
No.1	Line1	✎
No.2	Line2	✎
No.3	Line3	✎

U-turn Filtering**Draw U-turn Areas** ⓘDraw**Children Distinction****Staff Detection** ⓘ**Group Counting****Region Monitoring****Heat Map****Reset Cumulative Count on Schedule** ⓘ

Parameters	Description
Installation Height	Set the device installation height. Click Detect to detect the current installation height automatically. Note: 1) Ensure that there is no object directly below the device avoiding interfering the height detection. 2) The automatic detection of the installation height is not supported

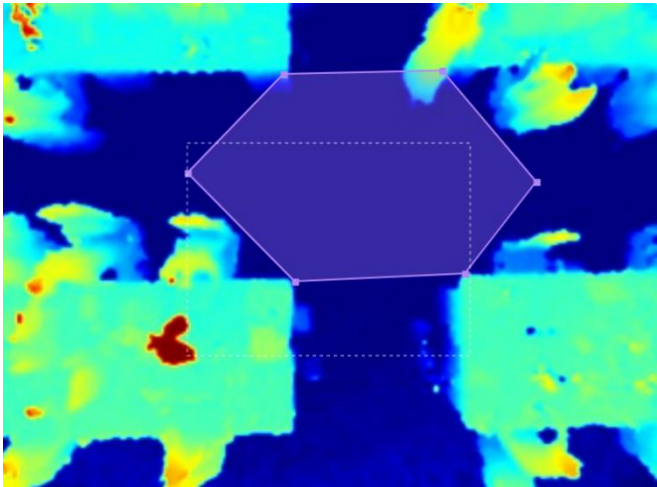
	with dark floor/carpet (black, grey, etc.)
Max. Target Height	Set the maximum target height, then the device will ignore the objects higher than this setting value.
Min. Target Height	Set the minimum target height, then the device will ignore the object shorter than this setting value.
Tracking Mode	Select the tracking mode of counting, including Heads Tracking and Feet Tracking. Note: It is recommended to use heads tracking mode when the installation height is low in standalone working mode.
U-turns Filtering	When enabled, it allows to draw an area for every line and the device will count the In and Out values only when people pass this area. Users can left-click to start the drawing and add edges for this area, then right-click to stop drawing.
Children Distinction	The device will detect the people shorter than child filter height as children.
Staff Detection	The device will detect the people who wear reflective stripes as staff tags on the visible parts (neck, shoulders, etc.) as staffs. Reflective stripe requirements: width > 2cm, 500 cd/lux.m ²
Group Counting	Click to enable the group counting function that based on the distance, moving direction and speed difference to gain deeper insights into customer' behaviors. Note: 1) This function is only applicable for line cross people counting. 2) LoRa reporting only transmit group counting data when group counting function is enabled.
Region Monitoring	Click "+Add" to add the region monitoring. Up to 4 regions are supported with maximum 10 segments each. Step 1: Draw the region monitoring areas on the screen.  Step 2: You can customize the zone name. And click to enable Region People Counting and Dwell Time Detection as needed. Pass-by Filtering can be set to improve statistical accuracy and Min.Dwell Time can be set to improve statistical validity.

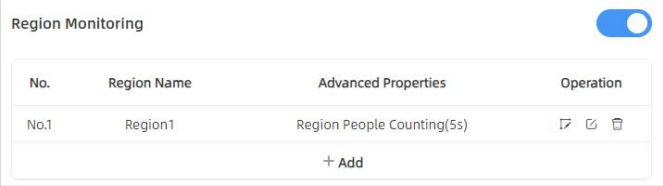
	<p>Advanced Properties</p> <p>Zone Name <input type="text" value="Region1"/></p> <p>Region People Counting <input checked="" type="checkbox"/></p> <p>Pass-by Filtering <input type="text" value="5"/> <small>s(0-3600)</small></p> <p>Dwell Time Detection <input checked="" type="checkbox"/></p> <p>Min. Dwell Time <input type="text" value="5"/> <small>s(0-3600)</small></p> <p><input type="button" value="X"/> <input checked="" type="button" value="✓"/></p> <p>Step 3: The configuration is displayed in the list after the configuration is complete. You can redraw the areas by clicking the redraw button in the list. Click the edit button to modify the advanced settings of the areas or click delete button to delete the areas separately.</p> 
Heat Map	<p>Click to enable Heat Map function. Heat Map function can analyze person movement to reveal insights for better business management with the intuitive and accurate statistical analysis results in time or space pattern as needed.</p> <p>Support Motion Heat Map and Dwell Heat Map. The motion heat map shows where the most people flow. And the dwell heat map shows the areas where people stay for the longest time.</p>
Reset Cumulative Count on Schedule	<p>Enable to periodically reset cumulative count on schedule.</p> <p>Cumulative Count includes:</p> <p>Total In/Out counting of each detection line.</p> <p>Max./Avg. Dwell Time of each detection region.</p>

Note:

Due to the error in ToF distance measurement (0.035 m), the Max. Target Height should be set as maximum pedestrian height plus 0.035 m and the Min. Target Height as minimal pedestrian height minus 0.035 m in the actual applications. For example, if the pedestrian height is 1.6 m to 1.8 m, the Max. and Min. Target Height should be configured as 1.835 m and 1.565 m respectively.

5.3 Communication

5.3.1 Network Configuration

VS135-L08EU supports Wi-Fi for web access and cellular for data transmission.

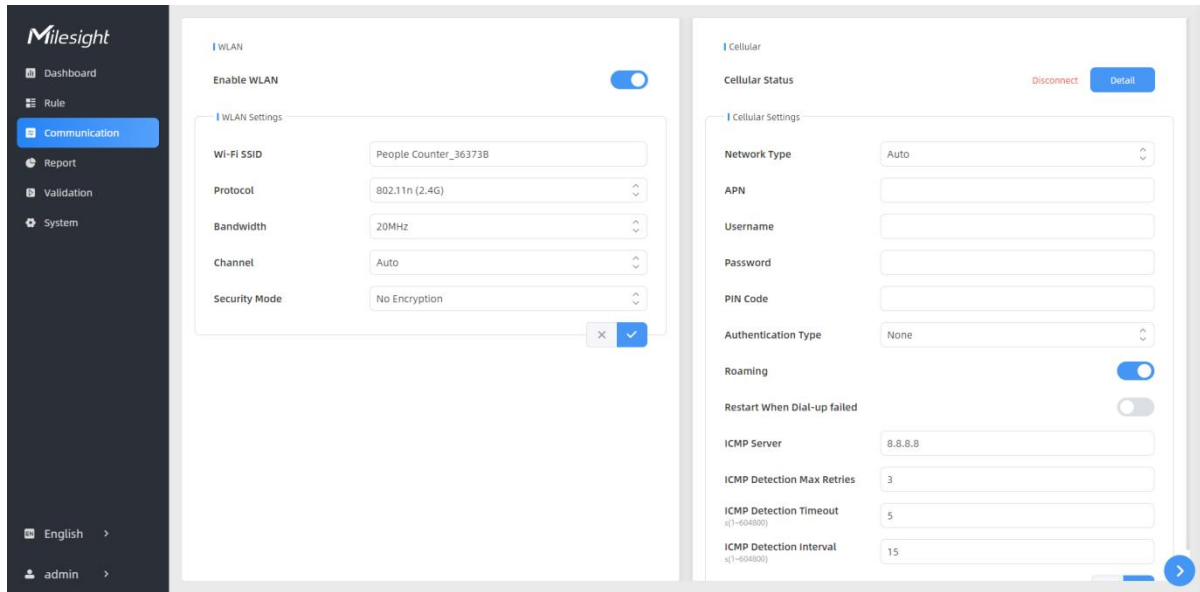

WLAN

Parameters	Description
Enable WLAN	Enable or disable Wi-Fi feature. If disabled, users can use button to enable it.
Wi-Fi SSID	The unique name for this device Wi-Fi access point, defined as People Counter_xxxxxx (can be found on the device label).
Protocol	802.11g (2.4 GHz) and 802.11n (2.4 GHz) are optional.
Bandwidth	20 MHz or 40 MHz are optional.
Channel	Select the wireless channel. Auto, 1,...11 are optional.
Security Mode	No Encryption, WPA-PSK, WPA2-PSK and WPA-PSK/WPA2-PSK are optional.
Cipher	AES, TKIP, AES/TKIP are optional.
Wi-Fi Password	Customize the password when security mode is not No Encryption.

Cellular

Parameters	Description	
Cellular	Cellular Status	Display the connection status of the network, including "connect" and "disconnect". You can also click "Detail" button to view the cellular status.
Cellular Settings	Network Type	Select from "Auto", "4G Only", and "3G Only". Auto: connect to the network with the strongest signal automatically. 4G Only/3G Only: connect to 4G/3G network only.
	APN	Enter the Access Point Name for cellular dial-up connection

		provided by local ISP. The max length is 31 characters.
Username		Enter the username for cellular dial-up connection provided by local ISP. The max length is 31 characters.
Password		Enter the password for cellular dial-up connection provided by local ISP. The max length is 31 characters.
PIN Code		Enter a 4-8 characters PIN code to unlock the SIM.
Authentication Type		Select the Authentication Type. None, PAP, CHAP, PAP and CHAP are optional.
Roaming		Click to enable the Roaming.
Restart When Dial-up Failed		Enable automatic device restart when multiple dial-up failed.
ICMP Server		Configure the IP address of the ICMP detection server.
ICMP Detection Max Retries		Set the maximum number of retries when ICMP detection failed.
ICMP Detection Timeout		Configure ICMP detection timeout.
ICMP Detection Interval		Configure ICMP detection interval.

Cellular Status

Parameters		Description
Cellular Status	Refresh	Click this button to manually refresh the above status.
	Modem Status	Show the corresponding detection status of the module and SIM card. <ul style="list-style-type: none"> ● No SIM Card ● SIM Card Error ● PN Error ● PIN Required ● PUK Required ● No Signal ● Ready ● Down SIM
	Model	Show the model name of the cellular module
	Version	Show the version of the cellular module.
	Signal Level	Show the current signal strength of the network.
	Register Status	Show the connection status of the network, including "connect" and "disconnect".
	IMEI	Show the IMEI of the module.
	IMSI	Show IMSI of the SIM card.
	ICCID	Show ICCID of the SIM card.
	ISP	Show the network provider which the SIM card registers on. Note: It will display "-" when the SIM card is not inserted or not recognized.
Network Type	Show the connected network type, such as LTE and 3G. Note: It will display "-" when the device is not connected to	

		network.
	PLMN ID	Show the current PLMNID, including MCC, MNC, LAC, and Cell ID.
	LAC	Show the location code of the SIM card. Note: It will display "-" when the SIM card is not inserted or not recognized.
	Cell ID	Show the Cell ID of the SIM card location. Note: It will display "-" when the SIM card is not inserted or not recognized.
	Network Status	Show the Network Status, IP Address, Netmask, Gateway and DNS Address of the current network. If the SIM card is not inserted or not recognized, it will display 0.0.0.0.
	IP Address	
	Netmask	
	Gateway	
	DNS	
	Connection Duration	Show the cellular dial-up connection duration.



5.3.2 Recipient & API

Recipient

VS135 supports to add data receivers (supports HTTP(s)/MQTT(s)). The device will proactively push data to the receivers according to the configured reporting scheme.

Note: Up to 8 receivers can be added.

Recipient

Recipient Name	URL/Host	Protocol	Status	Operation
Recipient	https://data....	HTTP(S)	Connected	 
+ Add				

Parameters	Description
Recipient Name	Show the recipient name.
URL/Host	Show the URL/host of HTTP(s) server or MQTT broker.
Protocol	Show the report protocol.
Status	Show connection status from device to HTTP(s) server or MQTT broker.
Operation	Click to edit the information or delete the recipient.

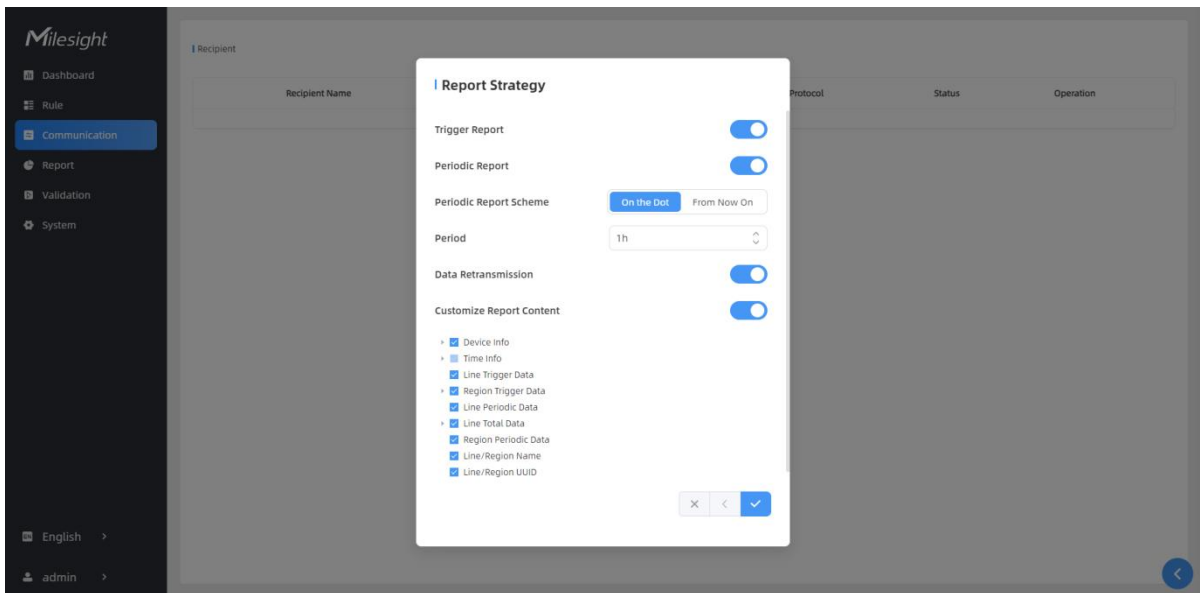
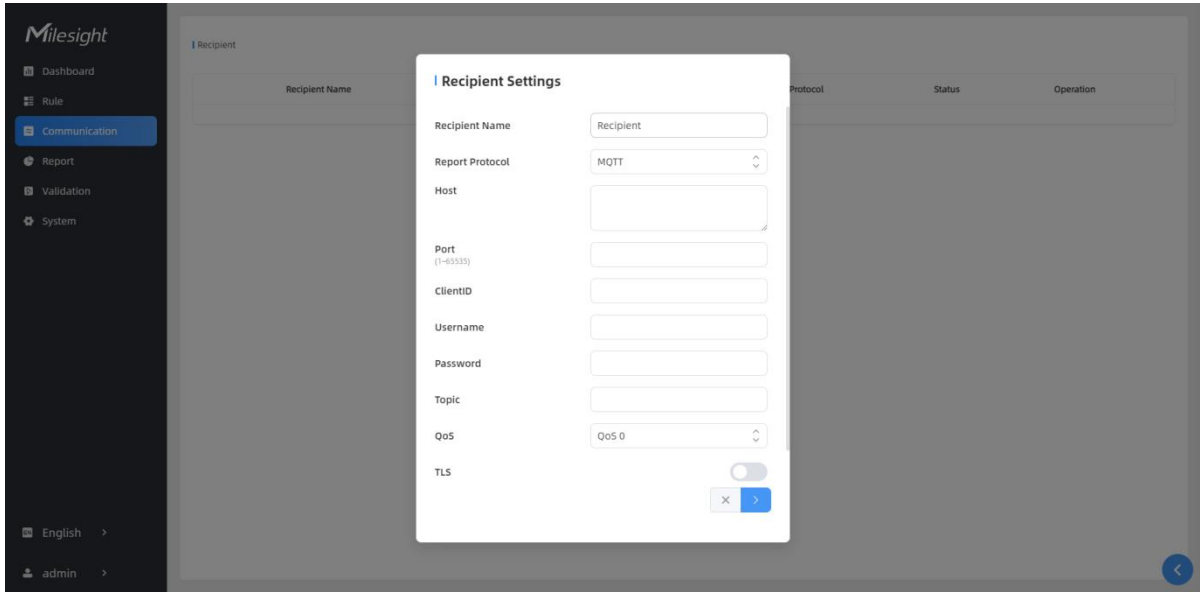

Parameters	Description
Recipient Name	Customize the recipient name.
Protocol	HTTP(s) or MQTT is optional.
Status	Show connection status from device to HTTP server or MQTT broker.
HTTP(s)	
Connection Test	Click Test to send test message to URL to check connectivity.
URL	The device will post the people counting data in json format to this URL.
User	The username used for authentication.
Password	The password used for authentication.
MQTT	
Host	MQTT broker address to receive data.
Port	MQTT broker port to receive data.
Client ID	Client ID is the unique identity of the client to the server.

	It must be unique when all clients are connected to the same server, and it is the key to handle messages at QoS 1 and 2.
Username	The username used for connecting to the MQTT broker.
Password	The password used for connecting to the MQTT broker.
Topic	Topic name used for publishing.
QoS	QoS0, QoS1, and QoS2 are optional.
TLS	Enable the TLS encryption in MQTT communication.
Certificate Type	CA Signed Server or Self Signed is optional. CA signed server certificate: verifying with the certificate issued by Certificate Authority (CA) that is pre-loaded on the device. Self signed certificates: upload the custom CA certificates, client certificates and secret key for verification.

Report Strategy

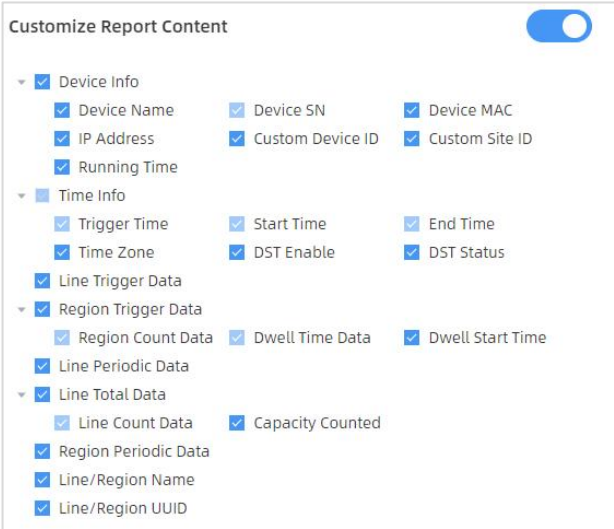
Trigger Report	Report immediately when there is a change of the line crossing people counting number or region people counting number.
Periodic Report	Select the periodic report of "On the Dot" or "From Now On".
Periodic Report Scheme	On the Dot: The device will report at the top of each hour. For example, When the interval is set to 1 hour, it will report at 0:00, 1:00, 2:00 and so on; when the interval is set to 10 minutes, it will report at 0:10, 0:20, 0:30, and so on.
Period	From Now On: Begin reporting from this moment onwards and regularly report based on the interval cycle.
Data Retransmission	Enable to resend stored data packets from the disconnected period when the device's network connection is restored. Every recipient supports to receive 50,000 pieces of data at most.
Customize Report Content	Customizable selection of content to be reported, avoiding data redundancy. 

MQTT API

VS135 provides MQTT API to support to receive downlink commands from MQTT broker to achieve the configuration.

MQTT API

Status Disconnected

Host

Port (1~65535)

Topic

Client ID

Username

Password

QoS

TLS

Parameters	Description
Status	Show connection status between device and MQTT broker.
Host	MQTT address to receive data.
Port	MQTT port to receive data.
Topic	Client ID is the unique identity of the client to the server. It must be unique when all clients are connected to the same server, and it is the key to handle messages at QoS 1 and 2.
Client ID	The username used for connecting to the MQTT.
Username	The password used for connecting to the MQTT.
Password	Topic name used for publishing.
QoS	QoS0, QoS1, QoS2 are optional.
TLS	Enable the TLS encryption in MQTT communication.
Certificate Type	CA Signed Server or Self Signed is optional. CA signed server certificate: verifying with the certificate issued by Certificate Authority (CA) that is pre-loaded on the device. Self signed certificates: upload the custom CA certificates, client certificates and secret key for verification.

5.4 Report

VS135 supports to generate visual line chart or bar chart to display the people traffic and supports to export the report. Before using this feature, **ensure that the device time is correct on System page.**

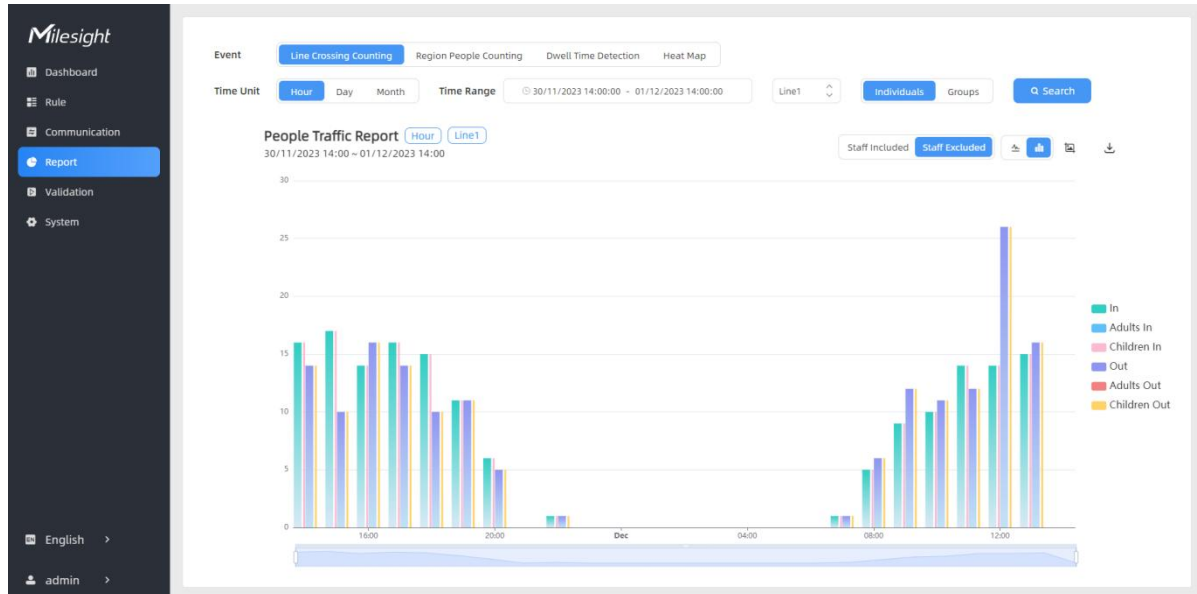

Parameters	Description
Event	Select the event which you want to query the report. Line crossing counting, region people counting, dwell time detection and heat map are optional.
Time Unit	Select the unit to generate the graph or export the data.
Time Range	Select the time range to generate the graph.
Line1	Select the line to display the graph.
Individuals Groups	Select the individuals counting reports or groups counting reports.
Region1	Select the region to display the graph.
Report Type	For heat map report, Motion Heatmap and Dwell Heatmap are optional.
Search	Click to generate the graph according to the time range and line option.
Export	Export the historical traffic data as CSV file according to the selected time unit. The device can store up to one million data records to CSV file.
Staff Included/Excluded	Select whether to contain staff counting values on the graph.
Line/Bar	Select the display type as line or bar.



Download the graph screenshot.









5.5 Validation

Video validation function can assist users in verifying the accuracy of people counting by setting up a video task of recording.

Note:

- Only one video task can be performed at a time, please delete the previous task before creating a new one.
- Detection rules and ToF frequency parameters cannot be modified during the recording process.

Parameters		Description
Video	Start Recording	Clicking "Start Recording" to initiate the recording task. You

Task		can manually click "Stop Recording" to end the recording, or it will automatically stop when the recording time reaches 60 minutes.
	Set a Task of Recording	<p>Configure the start time and duration of the recording. The duration can be set from 1 to 240 minutes. Clicking "Cancel Task" manually will cancel the recording schedule.</p> 
Playback Button		Enable/Disable detection lines in the recording footage.
		Enable/Disable u-turn area in the recording footage.
		Enable/Disable detection region in the recording footage.
		Enable/Disable tracking line in the recording footage.
		Rewind/Pause/Play/Forward(supports switching between 0.5x, 1x, 2x, and 4x playback speed).
		Start time and end time of the recording.
		Download video stream footage.

5.6 System

5.6.1 Device Info

All information about the hardware and software can be checked on this page. Besides, users can modify the device name, customize device ID and site ID for large amounts of devices management.

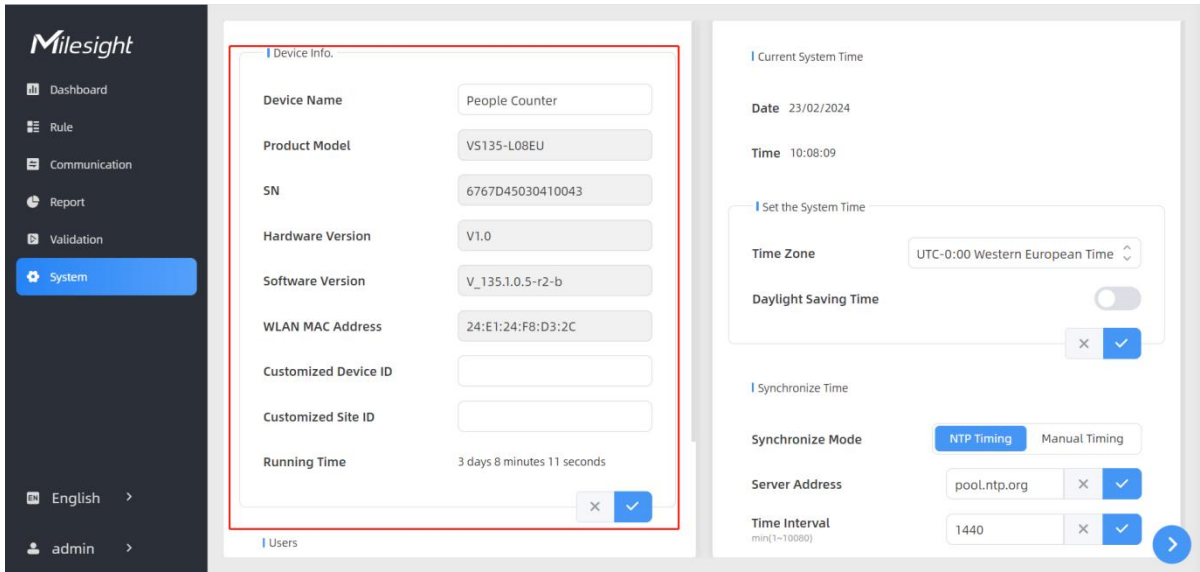

5.6.2 User

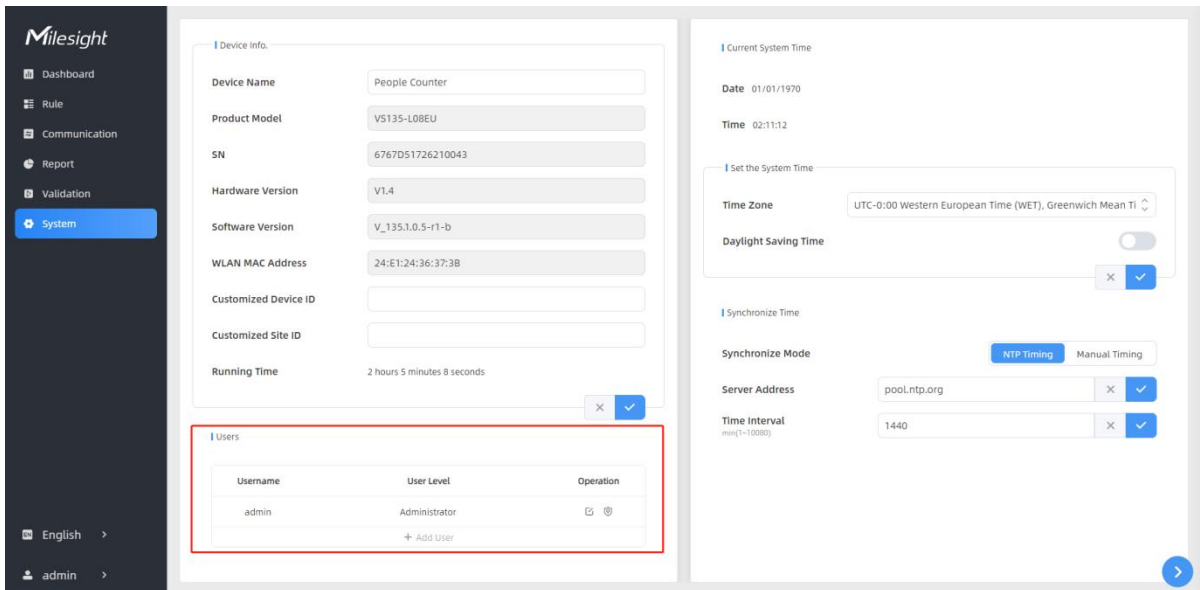

Parameters	Description
✎	You can change the login password of this device.

Users modify

Username	<input type="text" value="admin"/>
User Level	<input type="text" value="Administrator"/>
Administrator Password	<input type="password"/>
New Password	<input type="password"/>
Confirm	<input type="password"/>

At least:

- 8 characters
- 2 types of characters: Number, letter and symbol



Click to set three security questions for your device. In case that you forget the password, you can click **Forget Password** button on login page to reset the password by answering three security questions correctly.

Secure Question Settings Already Set

Password	<input type="password"/>
Security Question1	<input type="text" value="What is your lucky number?"/>
Answer1	<input type="text"/>
Security Question2	<input type="text" value="What is your favorite sport?"/>
Answer2	<input type="text"/>
Security Question3	<input type="text" value="What is your favorite game?"/>
Answer3	<input type="text"/>



Click to add a viewer, who will only have access to the "Dashboard" and "Report" interfaces.

Add User

Username	<input type="text" value="viewer"/>
User Level	<input type="text" value="Viewer"/>
Password	<input type="password"/>
Confirm	<input type="password"/>

At least:

- 8 characters
- 2 types of characters: Number, letter and symbol



5.6.3 Time Configuration

Username	User Level	Operation
admin	Administrator	
+ Add User		

Parameters	Description
Time Zone	Choose the time zone for your location.
Daylight Saving Time	Enable or disable Daylight Saving Time (DST). Start Time: the start time of DST time range. End Time: the end time of DST time range. DST Bias: the DST time will be faster according to this bias setting.
Synchronize Mode	NTP Timing or Manual Timing is optional.
Server Address	NTP server address to sync the time.
Time Interval	Set the interval to sync time with NTP server.
Setting Time	Set the device time manually.

5.6.4 Remote Management

Users can connect the device to the Milesight DeviceHub management platform on this page so as to manage the device centrally and remotely. For more details, please refer to [DeviceHub User Guide](#). **Before connecting, ensure the device has connected to network via Ethernet port and Internet connection is seamless.**

Parameters	Description
Status	Show the connection status between the device and the DeviceHub.
Server Address	IP address or domain of the DeviceHub management server.
Activation Method	Select activation method to connect the device to the DeviceHub server, options are Authentication Code and Account .

5.6.5 System Maintenance

Parameters	Description
Frequency Adjustment	Adjust the ToF frequency modulation mode to avoid the interference of surrounding IR devices. When using Multi-Device Stitching, please avoid using the same mode with other node devices. Note: If there is only one option, please contact Milesight IoT support:

	iot.support@milesight.com
ToF Lighting Mode	Adjust the ToF light mode as Always On or Auto. When using Auto mode, the device will turn off the ToF light when radar detects no person for some times to save the power.
Tilt Correction	Enable to automatic compensation of person height values when the device is mounted at a tilt.
Reset	Recovery device basic configuration: keep the IP settings and user information when resetting.
	Recovery device to factory settings: reset device to factory default, which needs to verify admin password.
Reboot	Restart the device immediately.
Upgrade	Click the folder icon and select the upgrading file, then click the Upgrade button to upgrade. The update will be done when the system reboots successfully. Note: The upgrade process takes about 1-10 minutes. Do not turn off the power and complete automatic restart after the upgrade.
Backup and Restore	Export Config File: Export configuration file.
	Import Config File: Click the file icon and select the configuration file, click Import button to import configuration file.

6. Installation Instruction

Parameter definition:

Parameters	Explanation	Value
H	Installation height	Standard Version: ≤ 3.5 m High Ceiling Mount: ≤ 6.5 m
d	Minimum detection distance of VS135	Standard Version: 0.5 m High Ceiling Mount: 2 m
Δd	Distance measurement error of VS135	0.035 m
h_{\max}	Maximum pedestrian height	Example 1.8 m
h_{\min}	Minimum pedestrian height	Example 1.7 m
α	ToF horizontal field of view angle	Standard Version: 98° High Ceiling Mount: 60°
β	ToF vertical field of view angle	Standard Version: 80° High Ceiling Mount: 45°
x	Length of detection range	
y	Width of detection range	

6.1 Installation Height

- The maximum installation height is 3.5 m and the minimum installation height is $h_{max}+d+\Delta d$. For example, when the maximum pedestrian height is 1.8 m, then the minimum installation height is $1.8+0.5+0.035=2.335$ m.
- The maximum installation height is 6.5 m and the minimum installation height is $h_{max}+d+\Delta d$. For example, when the maximum pedestrian height is 1.8 m, then the minimum installation height is $1.8+2+0.035=3.835$ m.

6.2 Covered Detection Area

The detection area covered by the device is related to the field of view angle of the device, the installation height and the target height. The length of the detection area is approximately $x=1.155 \times (H-h_{min})$ and the width of the detection area is approximately $y=0.828 \times (H-h_{min})$.

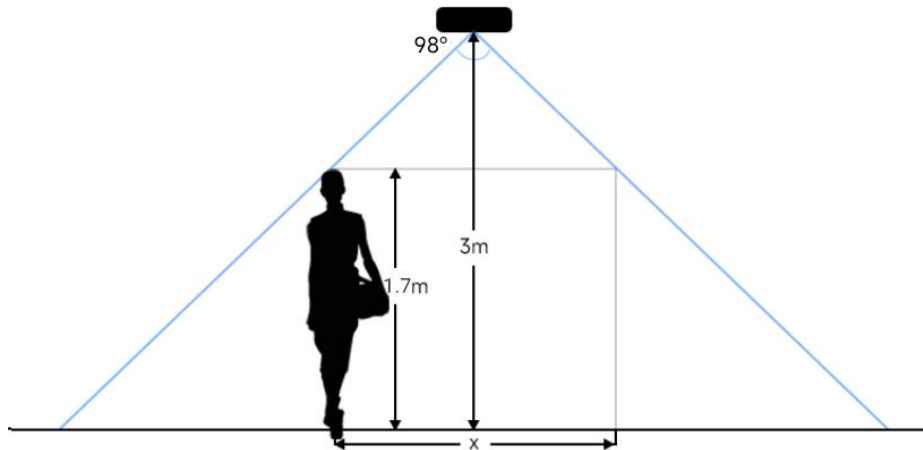

For example, if the Minimum height of pedestrians is 1.7 m, the detection area corresponding to each installation height is as follows:

Standard Version:

Installation Height (m)	Monitored Area (m)	Detection Area(m)
2.5	5.75 × 4.20	1.84 × 1.34
2.6	5.98 × 4.36	2.07 × 1.51
2.7	6.21 × 4.53	2.30 × 1.68
2.8	6.44 × 4.70	2.53 × 1.85
2.9	6.67 × 4.87	2.76 × 2.01
3.0	6.90 × 5.03	2.99 × 2.18
3.1	7.13 × 5.20	3.22 × 2.35
3.2	7.36 × 5.37	3.45 × 2.52
3.3	7.59 × 5.54	3.68 × 2.69

3.4	7.82 × 5.71	3.91 × 2.85
3.5	8.05 × 5.87	4.14 × 3.02

High Ceiling Mount:

Installation Height (m)	Monitored Area (m)	Detection Area(m)
3.5	4.04 × 2.90	2.08 × 1.49
3.7	4.27 × 3.07	2.31 × 1.66
3.9	4.50 × 3.23	2.54 × 1.82
4.1	4.73 × 3.40	2.77 × 1.99
4.3	4.97 × 3.56	3.00 × 2.15
4.5	5.20 × 3.73	3.23 × 2.32
4.7	5.43 × 3.89	3.46 × 2.49
4.9	5.66 × 4.06	3.70 × 2.65
5.1	5.89 × 4.22	3.93 × 2.82
5.3	6.12 × 4.39	4.16 × 2.98
5.5	6.35 × 4.56	4.39 × 3.15
5.7	6.35 × 4.72	4.62 × 3.31
5.9	6.81 × 4.89	4.85 × 3.48
6.1	7.04 × 5.05	5.08 × 3.65
6.3	7.27 × 5.22	5.31 × 3.81
6.5	7.51 × 5.38	5.54 × 3.98

6.3 Environment Requirements

- Dark floor/carpet (black, grey, etc.) will affect the device to count staffs when Staff Detection is enabled.

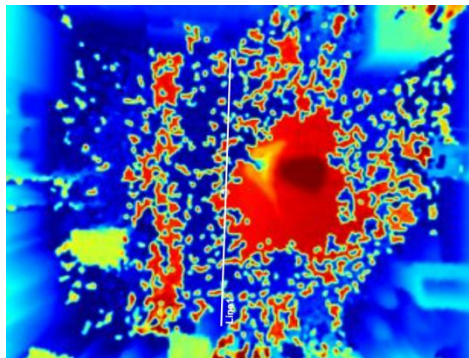

- Avoid 940nm light which may result in incorrect counting.
- Outdoor sunlight shining on the over channel will not have any effect, but the mirrored

reflections that allow sunlight to shine on the ToF Sensor should be avoided.

- When the carpet/floor is black, ensure there is no obstacle within a 60cm hemisphere range in the direction of the device. Otherwise, the device imaging may appear abnormally red.

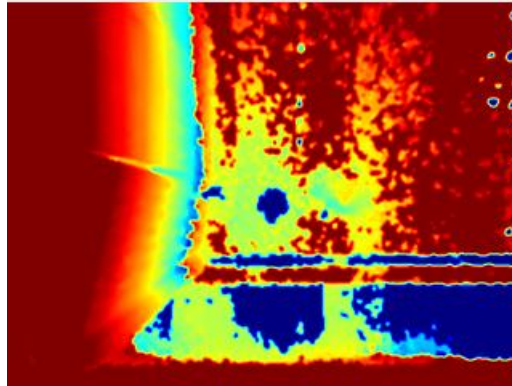
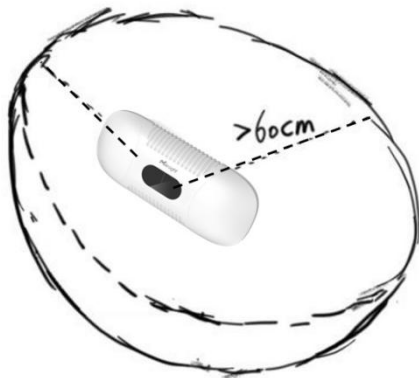

6.4 Installation

Ceiling Mount

Installation condition: ceiling thickness > 30mm.

Step 1: Take down the side covers.

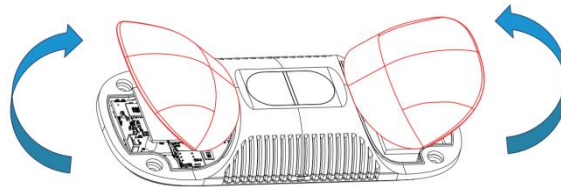

Step 2: Fix wall plugs into ceiling holes.

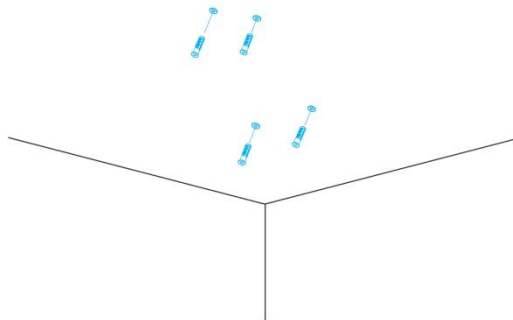

Step 3: Remove rubber plugs on the rubber sleeve, connect all required wires.

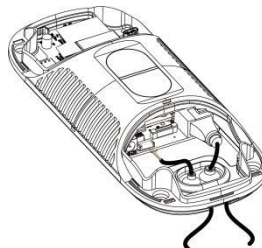

Note:

- Remove the rubber sleeve if waterproof is not required for easy installation.
- Use round wires.
- Ensure the rubber sleeve and the bottom cover are tightly connected without a gap if waterproof is required; if necessary, wrap the waterproof tapes around the wires to avoid any gap.
- Tighten the wires to avoid contact with internal modules.

Step 4: Fix the device to ceiling with mounting screws.

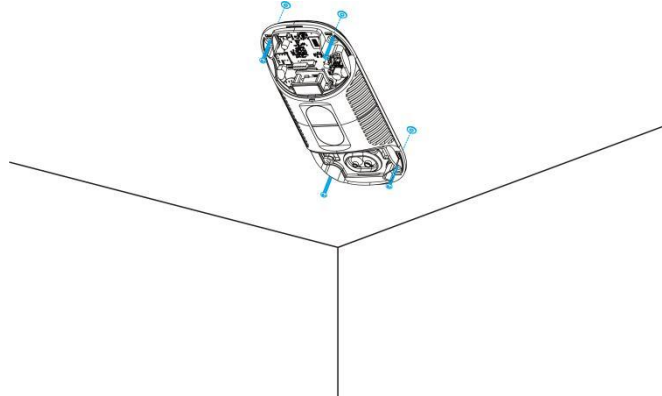

Step 5: Restore side covers.

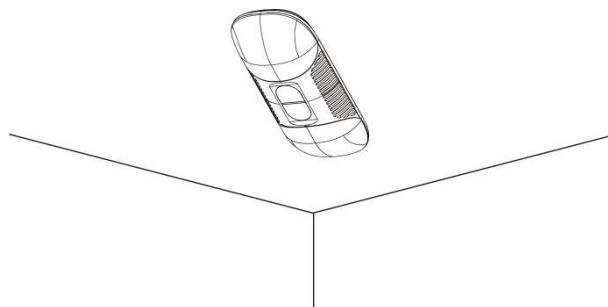

Ceiling/Lintel Mount (with Optional VB01 Multifunctional Bracket)

Step 1: Fix the pole to the device with the hole on the device.

Step 2: Adjust the length of the pole, then adjust the direction of 3-axis ball and tighten it with the handle.

Step 3: Determine the mounting location and drill 3 holes, fix the wall plugs into the mounting holes, then fix the bracket base to the wall plugs via mounting screws.

(**Note:** If the wire needs to be extended to the interior of the ceiling or wall, a wire hole with a suitable size is also required to be drilled.)

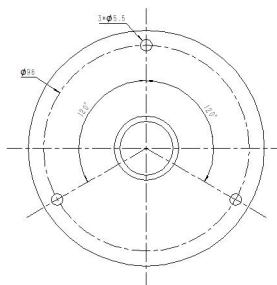

Step 4: Remove the cover on the device, and then connect all required wires and pass them through the inside of pole.

Step 5: Fix the pole to bracket base with screws and nuts.

Ceiling Mount

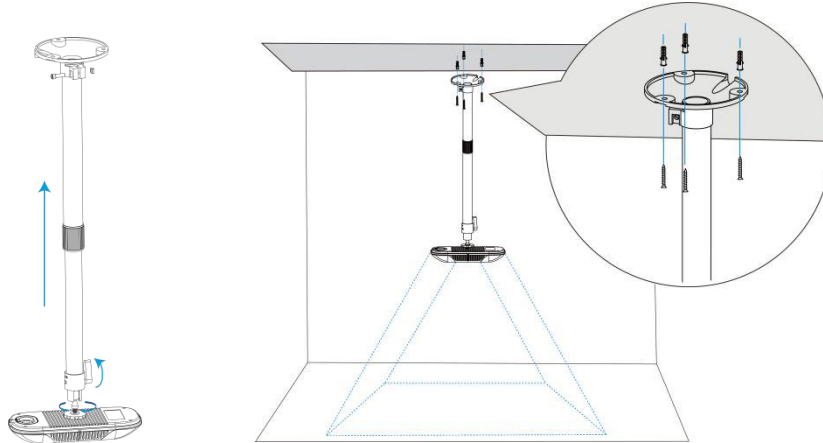

Lintel Mount

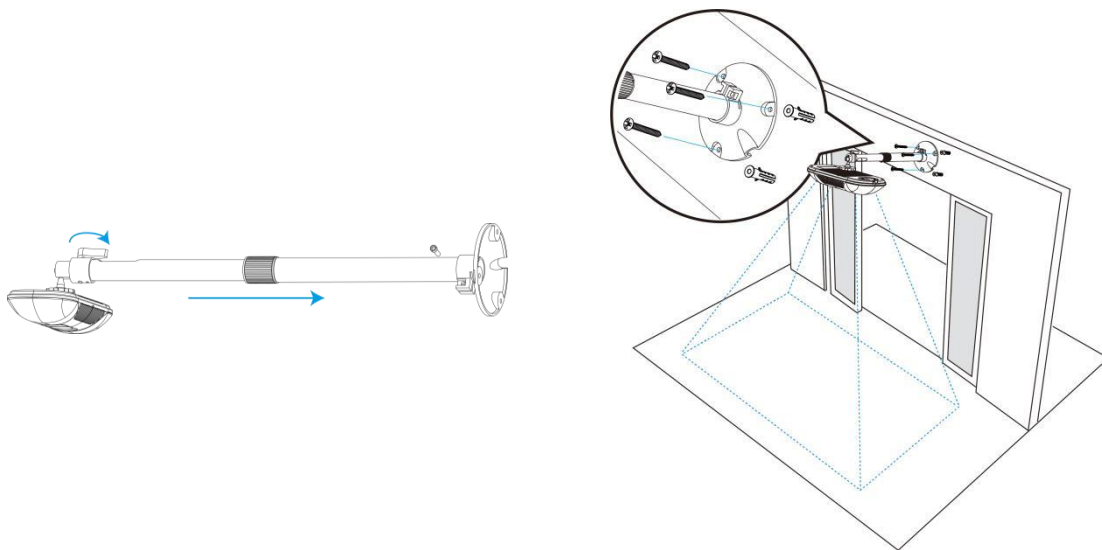

Installation Note:

- Ensure that the ToF sensor is facing down and the tilt angle from the ground is no greater than 15° for the standard version, and no greater than 10° for the high ceiling mount version.
- Avoid direct Infrared LED light in the detection area.
- Not suggested to install the sensor close to glass or mirror.
- Ensure that there are no other objects blocking the ToF light within a 50cm radius of the device's field of view.
- Though the device is compliant with Class 1 (IEC/EN 60825-1:2014), please DO NOT look at the ToF sensor too close and directly.
- Avoid installing the device against the wall and ensure the device keeps away from the wall

with a distance of at least 40cm.

- When you install devices on the top of swinging doors, it is suggested to keep the door normally open. If the door must be normally closed, please install the device on the other side of the door to keep away from the door's movement. And it is suggested to keep away from the door with a distance of at least 40cm.

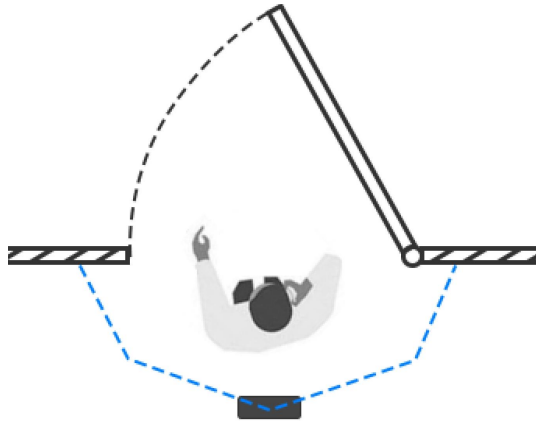

6.5 Factors Affecting Accuracy

- Wearing a fisherman's hat or carrying a cardboard box on the shoulder: The target will not be recognized because it will become unlike a human in depth map.
- Handheld or cart-carrying a humanoid doll with sufficient height to pass by: The doll will be mistakenly detected as people because it is human-like in depth map.

7. Communication Protocol

VS135 will post the people counting data in json format to HTTP URL or MQTT broker.

7.1 Line Crossing People Counting-Periodic Report

```
{  
  "device_info":  
    {  
      "device_name": "People Counter",  
      "device_sn": "369362028335",  
      "device_mac": "00:16:28:FA:8E:68",  
      "ip_address": "192.168.0.99",  
      "cus_device_id": "123468773",  
      "cus_site_id": "asdfasf1231231",  
      "running_time": 1564648484648  
    }  
}
```

```
    },
    "time_info":
    {
        "time_zone": "UTC-11:00 Samoa Standard Time (SST)",
        "enable_dst": false,
        "dst_status": false,
        "start_time": "2022-12-20T18:15:00+03:00",
        "end_time": "2022-12-20T18:15:00+03:00"
    },
    "line_periodic_data":
    [
        {
            "line": 1,
            "line_name": "line name",
            "line_uuid": "c2cff803-8311-4a73-8ff3-9348cf4fa0d9",
            "in": 10,
            "out": 9,
            "staff_in": 1,
            "staff_out": 1,
            "children_in": 0,
            "children_out": 0,
            "group_in": 1,
            "group_out": 0,
        },
        {
            "line": 2,
            "line_name": "line2 name",
            "line_uuid": "c2cff789-8311-4a73-8ff3-9348cf4fa0d9",
            "in": 0,
            "out": 1,
            "staff_in": 0,
            "staff_out": 0,
            "children_in": 0,
            "children_out": 0,
            "group_in": 0,
            "group_out": 0
        }
    ],
```

```
"line_total_data":  
  [  
    {  
      "line":1,  
      "line_name": "line name",  
      "line_uuid": "c2cff803-8311-4a73-8ff3-9348cf4fa0d9",  
      "in_counted":10,  
      "out_counted":9,  
      "capacity_counted":1,  
      "staff_in_counted":1,  
      "staff_out_counted":1,  
      "children_in_counted":0,  
      "children_out_counted":0,  
      "group_in_counted": 1,  
      "group_out_counted": 0,  
    },  
    {  
      "line":2,  
      "line_name": "line2 name",  
      "line_uuid": "c2cff789-8311-4a73-8ff3-9348cf4fa0d9",  
      "in_counted":10,  
      "out_counted":9,  
      "capacity_counted":1,  
      "staff_in_counted":1,  
      "staff_out_counted":1,  
      "children_in_counted":0,  
      "children_out_counted":0,  
      "group_in_counted": 1,  
      "group_out_counted": 0,  
    }  
  ]  
}
```

7.2 Line Crossing People Counting-Trigger Report

```
{  
  "device_info":  
    {
```

```
"device_name": "People Counter",
"device_sn": "369362028335",
"device_mac": "00:16:28:FA:8E:68",
"ip_address": "192.168.0.99",
"cus_device_id": "123468773",
"cus_site_id": "asdfasf1231231",
"running_time": 1564648484648
},
"time_info":
{
  "time_zone": "UTC-11:00 Samoa Standard Time (SST)",
  "enable_dst": false,
  "dst_status": false,
  "time": "2022-12-20T18:15:00+03:00"
},
"line_trigger_data":
[
  {
    "line": 1,
    "line_name": "line name",
    "line_uuid": "c2cff803-8311-4a73-8ff3-9348cf4fa0d9",
    "in": 1,
    "out": 0,
    "staff_in": 1,
    "staff_out": 0,
    "children_in": 0,
    "children_out": 0,
    "group_in": 1,
  },
  {
    "line": 2,
    "line_name": "line2 name",
    "line_uuid": "c2cff789-8311-4a73-8ff3-9348cf4fa0d9",
    "in": 0,
    "out": 1,
    "staff_in": 0,
    "staff_out": 0,
    "children_in": 0,
```

```
        "children_out":0,  
        "group_in": 0,  
        "group_out": 0  
    }  
]  
}
```

7.3 Region People Counting - Periodic Report

```
{  
  "device_info":  
    {  
      "device_name":"People Counter",  
      "device_sn":"369362028335",  
      "device_mac":"00:16:28:FA:8E:68",  
      "ip_address":"192.168.0.99",  
      "cus_device_id":"123468773",  
      "cus_site_id":"asdfasf1231231",  
      "running_time": 1564648484648  
    },  
  "time_info":  
    {  
      "time_zone":"UTC-11:00 Samoa Standard Time (SST)",  
      "enable_dst":false,  
      "dst_status":false,  
      "start_time":"2022-12-20T18:15:00+03:00",  
      "end_time":"2022-12-20T18:15:00+03:00"  
    },  
  "region_data":  
    {  
      "region_count_data":  
        [  
          {  
            "region":1,  
            "region_name":"Region1",  
            "region_uuid": "c2cff789-8311-4a73-8ff3-9348cf4fa0d9",  
            "current_total":10,  
            "current_staff":1,  
            "region_count":10,  
            "region_staff":1,  
            "region_start_time": "2022-12-20T18:15:00+03:00",  
            "region_end_time": "2022-12-20T18:15:00+03:00",  
            "region_start_time_offset": "2022-12-20T18:15:00+03:00",  
            "region_end_time_offset": "2022-12-20T18:15:00+03:00"  
          }  
        ]  
    }  
}
```

```
        "current_children":1
      },
      {
        "region":2,
        "region_name":"Region2",
        "region_uuid": "c2cff789-8311-4a73-8ff3-9348cf4faaca",
        "current_total":10,
        "current_staff":1,
        "current_children":1
      }
    ],
    "dwell_time_data":
    [
      {
        "region":1,
        "region_name":"Region1",
        "region_uuid": "c2cff789-8231-4a73-8ff3-9348cf4faaca",
        "max_dwell_time":156464,
        "avg_dwell_time": 156464,
        "staff_max_dwell_time":1522,"staff_avg_dwell_time":1522,
        "children_max_dwell_time":1522, "children_avg_dwell_time":1522
      },
      {
        "region":1,
        "region_name":"Region1",
        "region_uuid": "c2cff789-8231-4a73-8ff3-9348cf4faaca",
        "max_dwell_time":156464,
        "avg_dwell_time": 156464,
        "staff_max_dwell_time":1522,
        "staff_avg_dwell_time":1522,
        "children_max_dwell_time":1522,
        "children_avg_dwell_time":1522
      }
    ]
  }
}
```

7.4 Region People Counting - Trigger Report

```
{
  "device_info":
  {
    "device_name": "People Counter",
    "device_sn": "369362028335",
    "device_mac": "00:16:28:FA:8E:68",
    "ip_address": "192.168.0.99",
    "cus_device_id": "123468773",
    "cus_site_id": "asdfasf1231231",
    "running_time": 1564648484648
  },
  "time_info":
  {
    "time_zone": "UTC-11:00 Samoa Standard Time (SST)",
    "enable_dst": false,
    "dst_status": false,
    "time": "2022-12-20T18:15:00+03:00"
  },
  "region_trigger_data":
  {
    "region_count_data":
    [
      {
        "region": 1,
        "region_name": "Region1",
        "region_uuid": "c2cff789-8311-4a73-8ff3-9348cf4fa0d9",
        "current_total": 10,
        "current_staff": 1,
        "current_children": 1
      },
      {
        "region": 2,
        "region_name": "Region2",
        "region_uuid": "c2cff789-8311-4a73-8ff3-9348cf4faaca",
        "current_total": 10,
        "current_staff": 1,
        "current_children": 1
      }
    ]
  }
}
```

```
    }  
  ],  
  "dwell_time_data":  
  [  
    {  
      "region":1,  
      "region_name":"Region1",  
      "region_uuid": "c2cff789-8231-4a73-8ff3-9348cf4faaca",  
      "people_id":1,  
      "dwell_start_time":"2022-12-20T18:15:52+03:00",  
      "dwell_end_time":"2022-12-20T19:15:52+03:00",  
      "duration":5646,  
      "staff":false,  
      "children":true  
    },  
    {  
      "region":1,  
      "region_name":"Region1",  
      "region_uuid": "c2cff789-8231-4a73-8ff3-9348cf4faaca",  
      "people_id":2,  
      "dwell_start_time":"2022-12-20T17:15:52+03:00",  
      "dwell_end_time":"2022-12-20T19:15:52+03:00",  
      "duration":5646,  
      "staff":false,  
      "children":true  
    }  
  ]  
}
```

-END-