



SENSECAP

Quick Start for SenseCAP M2 Multi Platform Gateway & SenseCAP Sensors

This tutorial will guide you to connect the SenseCAP LoRaWAN® Sensors to SenseCAP M2 Multi Platform Gateways.

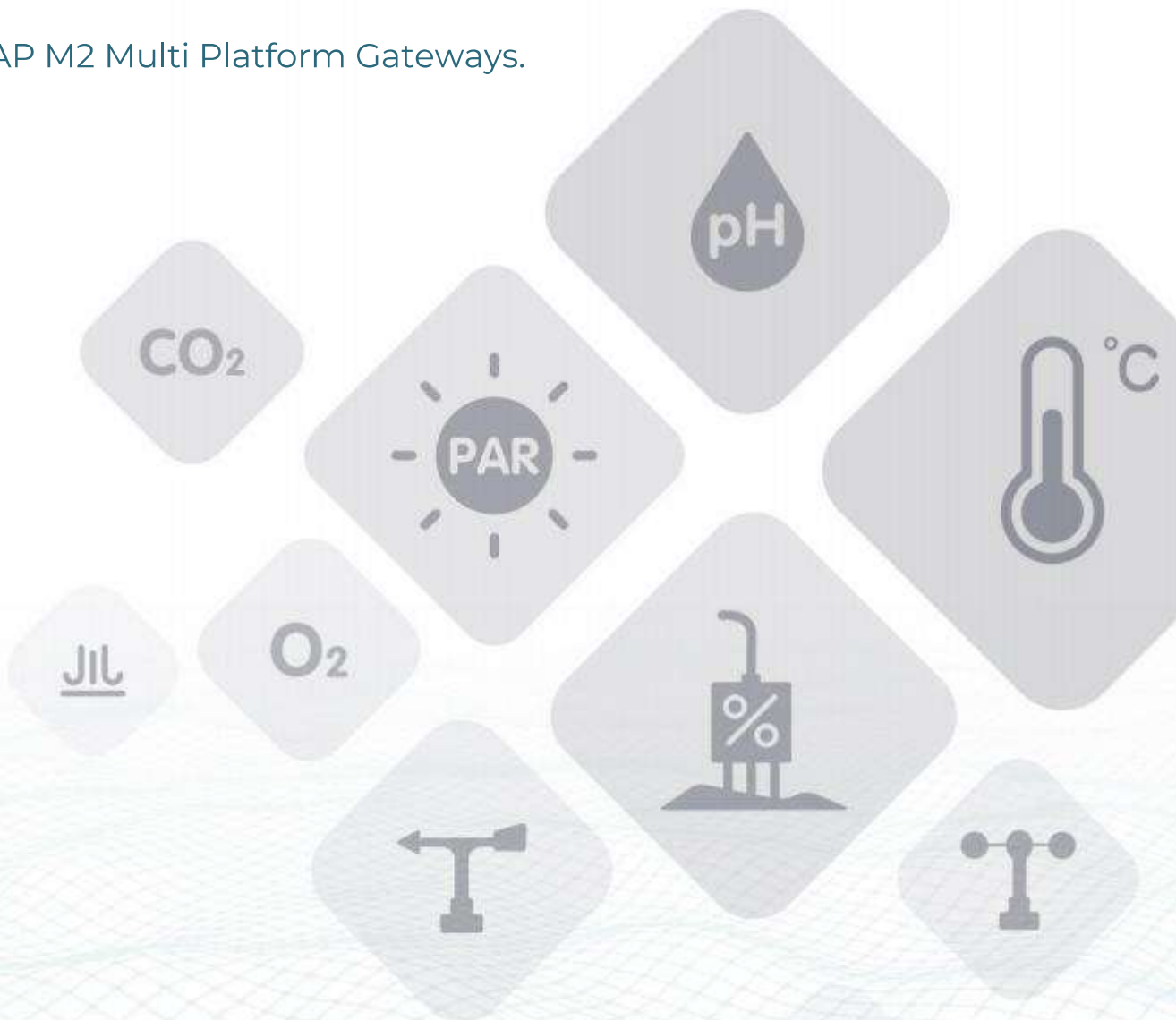

Table of Contents

1. Gateway Network Configuration	1
1.1 Connect to Ethernet Cable	1
1.2 Connect to WIFI via Luci	2
1.3 Connect with Cellular(for 4G version)	7
1.4 POE connection	8
1.5 Checking the Gateway Connection Status	9
2. Bind the gateway	10
3. Connect the SenseCAP Sensors	12
4. SenseCAP Portal and Mate APP	14
4.1 Gateway Info	14
4.2 Sensor data	15

1. Gateway Network Configuration

Connect the antenna and power adaptor to the gateway.

The power LED will show in red, and in about 15s, the indicator on the top will flash green, indicating that the gateway is booting.

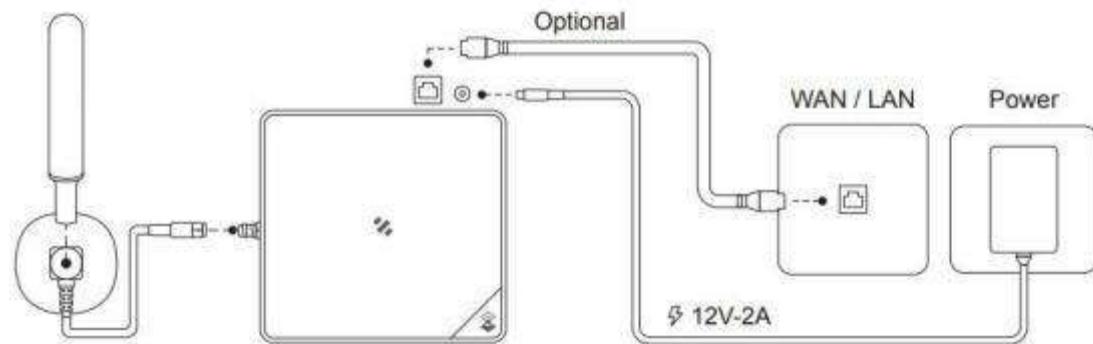

There are two ways to connect to the Internet. Choose the one that works for you.

1.1 Connect to Ethernet Cable

Connect the Ethernet cable to the Ethernet port, and the indicator on the top will show solid green if the gateway is successfully connected to the internet.

1.2 Connect to WIFI via Luci

There are two ways for users to login Luci configuration page.

1.2.1 Access via router

- **Step 1:** Connect your device to a Ethernet cable, and connect your PC to the same router.

Note: Your PC and device should be connected to the same router/network.

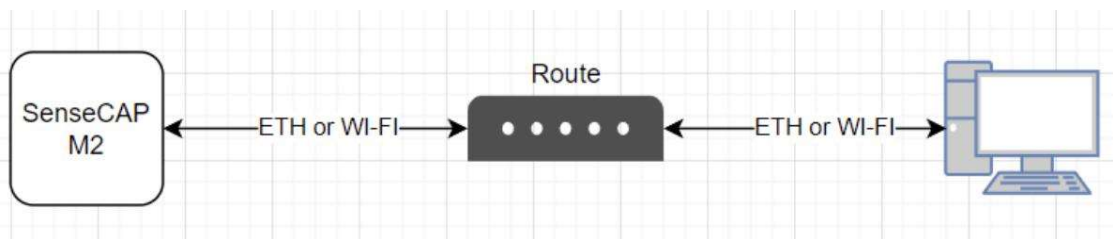

- **Step 2:** Get IP Address of your device

Check the IP Address of your device on your router admin page.

- **Step 3:** Get your device Username and Password

You can find the Username and Password on your device label.



- **Step 4:** Login Luci

Input the IP Address of your device in a browser to enter the Luci page. Then input your device username and password to login.

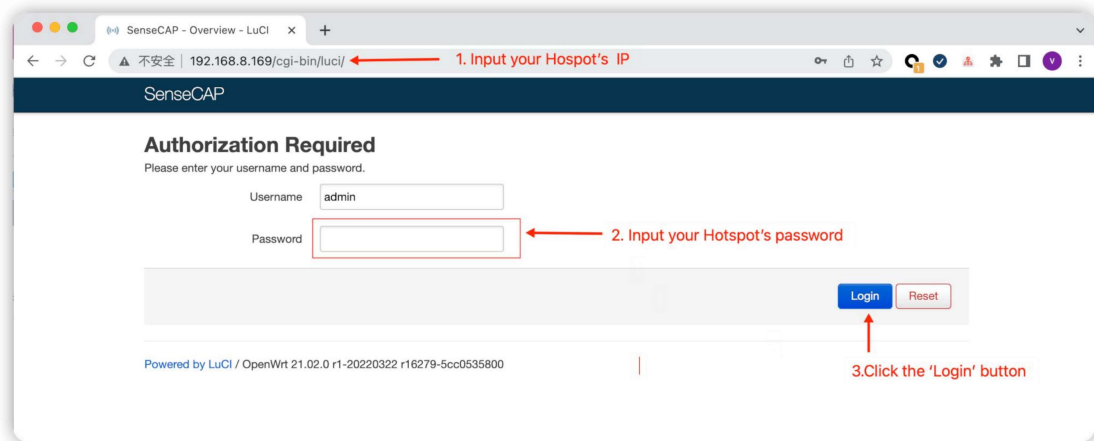

1.2.2 Access via device AP hotspot

- **Step 1:** Turn on the device AP hotspot.

Press the button for 5s until the blue indicator flashes slowly to enter the configuration mode.

- **Step 2:** Connect to the AP hotspot.

AP hotspot name is SenseCAP_XXXXXX (6-figure MAC address), default password is 12345678; connect your computer to this AP hotspot.



- **Step 3:** Get your device Username and Password

You can find the Username and Password on your device label.



- **Step 4:** Log in to the Local Console

Input the IP Address (192.168.168.1) in your browser to enter the Local Console. Then input your device username and password, and click the Login button.

SenseCAP

Authorization Required

Please enter your username and password.

Username

Password

1.2.3 Connect to a WIFI

Click on **Network - Wireless**

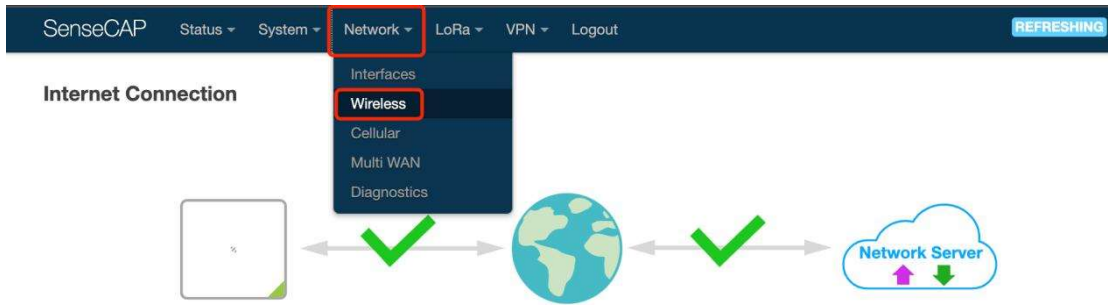

Click on the **Scan** button to scan the WIFI.

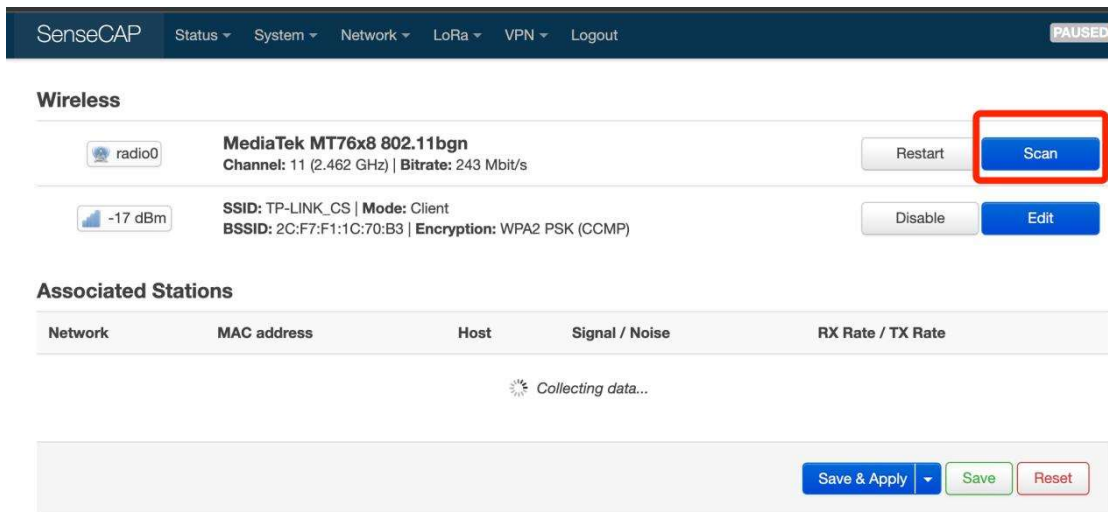

Select your WI-FI to join the network.

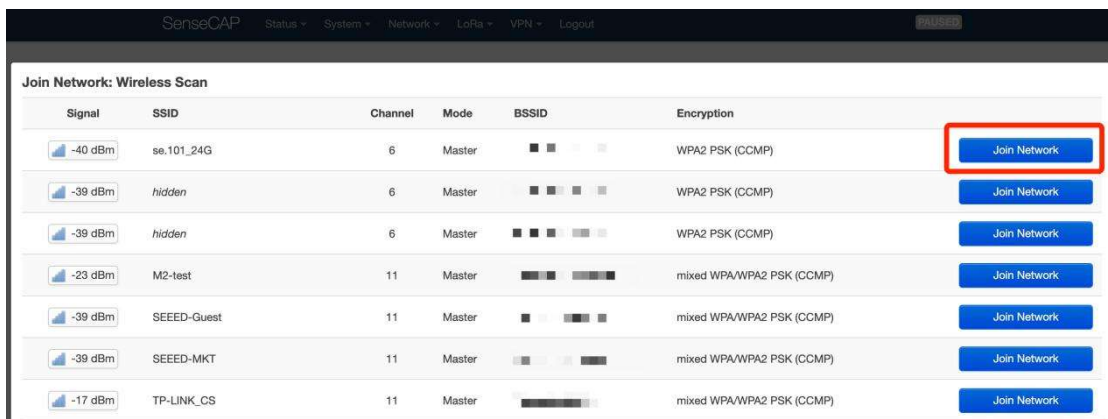

Submit the Wi-Fi password, and then click **Submit** and **Save**.

SenseCAP Status System Network LoRa VPN Logout

Joining Network: "se.101_24G"

Replace wireless configuration

Name of the new network

1 WPA passphrase [Specify the secret encryption key here.](#)

Lock to BSSID

Instead of joining any network with a matching SSID, only connect to the BSSID 34:2E:86:70:2A:24.

Cancel

2

Then click **Save and Apply** to apply your settings.

The indicator on the top will show solid green if the gateway is successfully connected to the WIFI.

1.3 Connect with Cellular(for 4G version)

- **Step 1:** Plug your SIM card into the Nano-SIM card slot

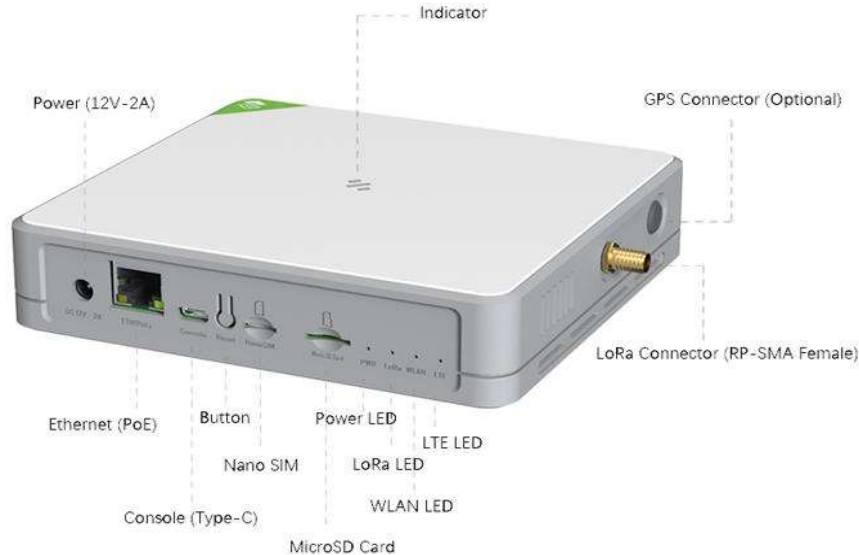

- **Step 2:** Login the Luci page, and click on **Network - Cellular**

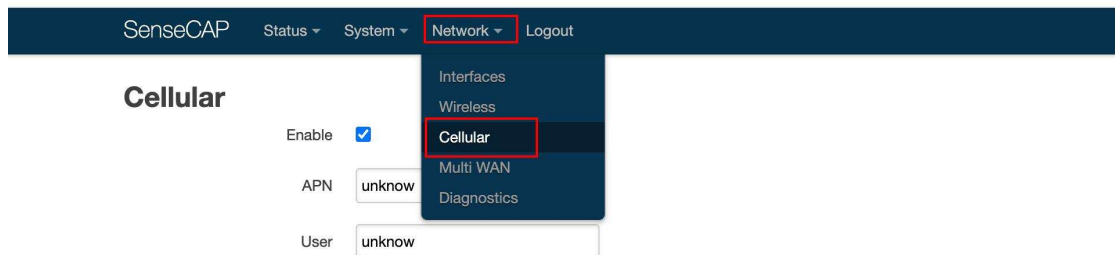

- **Step 3:** Setup the APN info, and click **Save and Apply** to apply your settings.

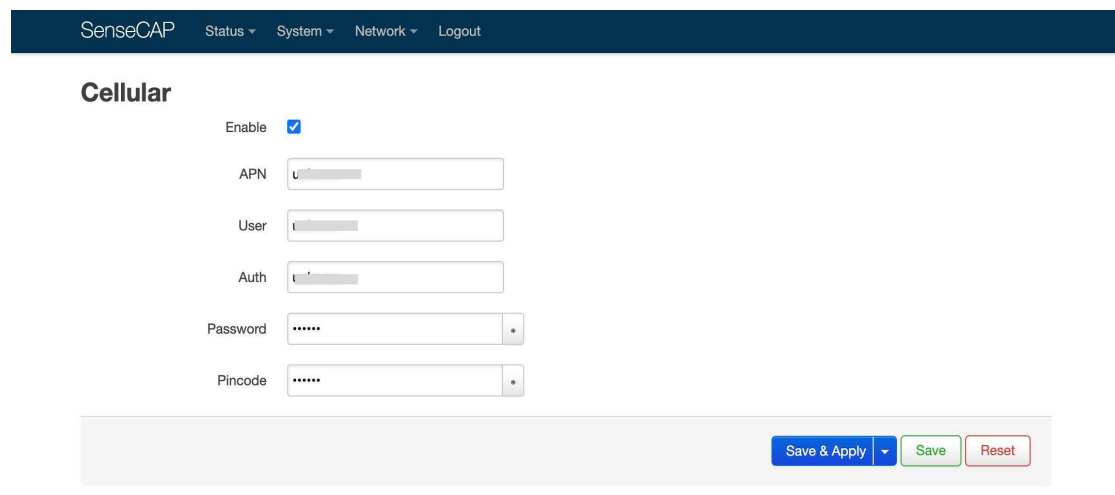

1.4 POE connection

SenseCAP M2 supports PoE (Power on Ethernet) and is compatible with IEEE 802.3 af standard.

 **Note:**

You will need to have an extra PoE switch that provides 40V-57V DC power as a PSE (Power Sourcing Equipment) if your modem/router does not support PoE.

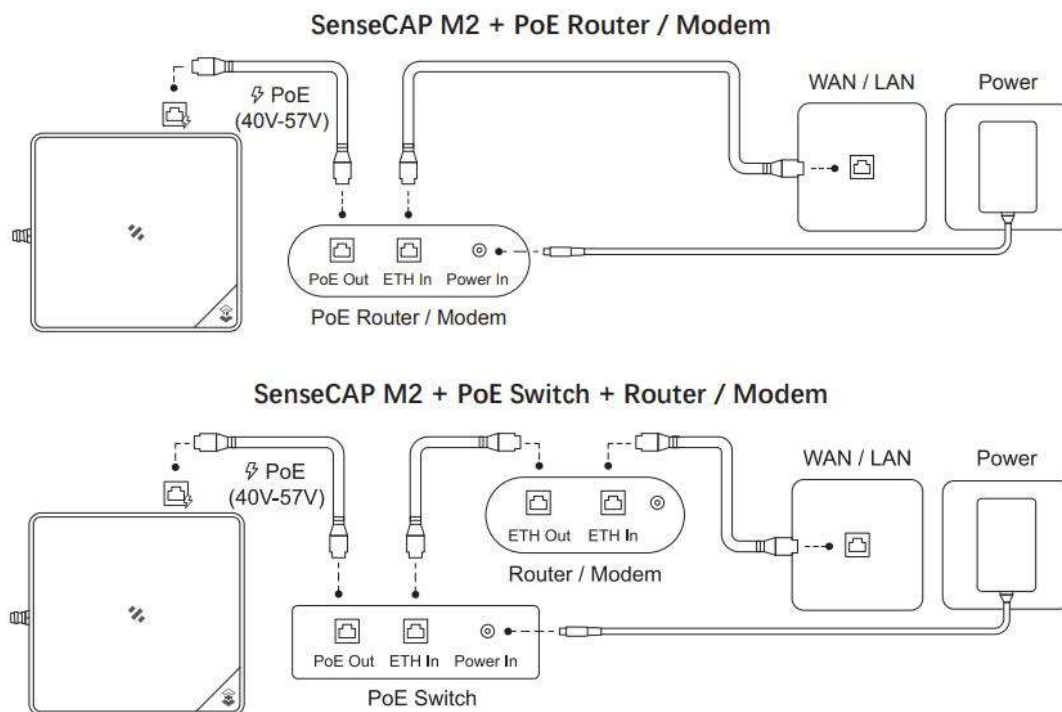

1.5 Checking the Gateway Connection Status

After powering on the gateway, there are two ways for you to check the gateway working status::

1) LED Indicator

	Mode	Description
Green	Solid	Gateway is healthy and the internet is well connected.
	Slow blinking	Gateway is booting, please wait.
Blue	Solid	The gateway is ready for internet connection. Further configuration is needed.
	Slow blinking	Configuration mode, and will auto exit after 5 mins if no activity.
	Fast blinking	Press the button for 30s until the indicator show fast flash will trigger the factory reset.
Orange	Slow blinking	Firmware is updating, and please do not power off the gateway or disconnect the internet.
White	Solid	Gateway is only with a factory firmware, and will be updated to the latest firmware automatically when it is connected to the internet.
Red	Solid	Hardware issue or internet connection failure.
	Slow blinking	Gateway not connected to the LNS.

2) SenseCAP Mate APP

In the SenseCAP Mate App, “Online status” indicates “Online” when the gateway is connected to the network and can receive and transfer sensor data.

Please refer to the next chapter for obtaining the SenseCAP App.

2. Bind the gateway

SenseCAP Mate APP supports device configuration and remote management.

- **Step 1:** Download the SenseCAP Mate APP

[SenseCAP Mate APP for iOS](#) on App Store

[SenseCAP Mate APP for Android](#) on the Google Play Store

You can also download App from [App Center](#)



Download SenseCAP Mate App

- **Step 2:** Login the APP

If it is your first time to use the SenseCAP platform, please register an account first.

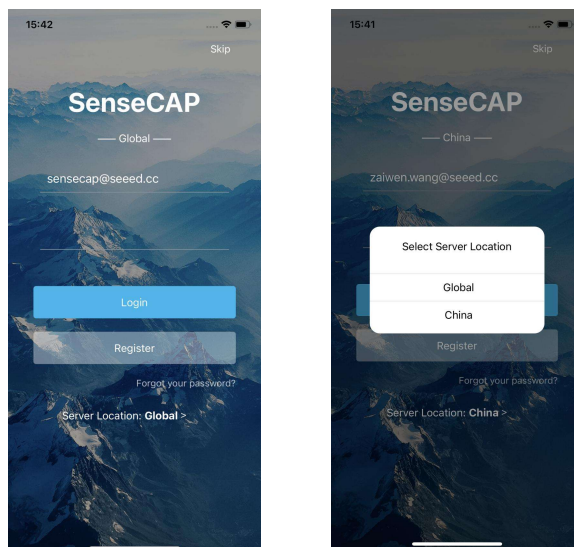

Note: Please select **Global** of Server Location.

- **Step 3:** Add device

Click the + in the upper right corner and select **Add device**

Then scan the QR code on your gateway label.

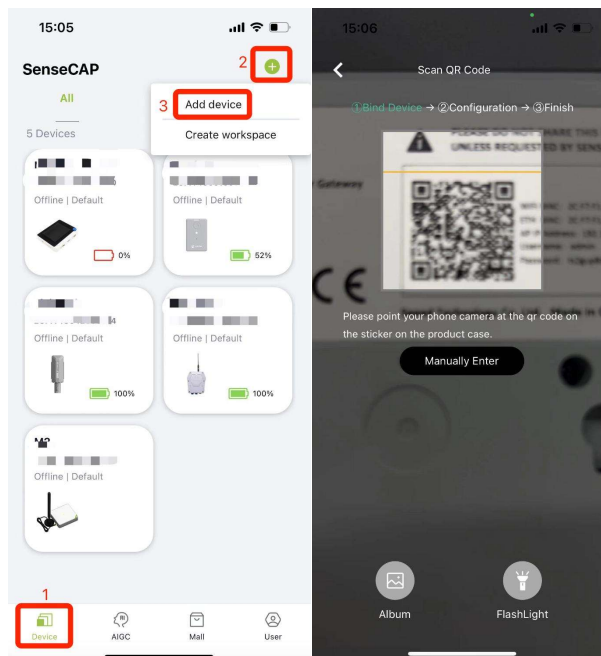

Set up your device name and location. Then confirm your settings.

After successful binding, you will see your gateway in the **Device** directory.



3. Connect the SenseCAP Sensors

- **Step 1:** Add device

Click the + in the upper right corner and select **Add device**

Then scan the QR code on your gateway label.

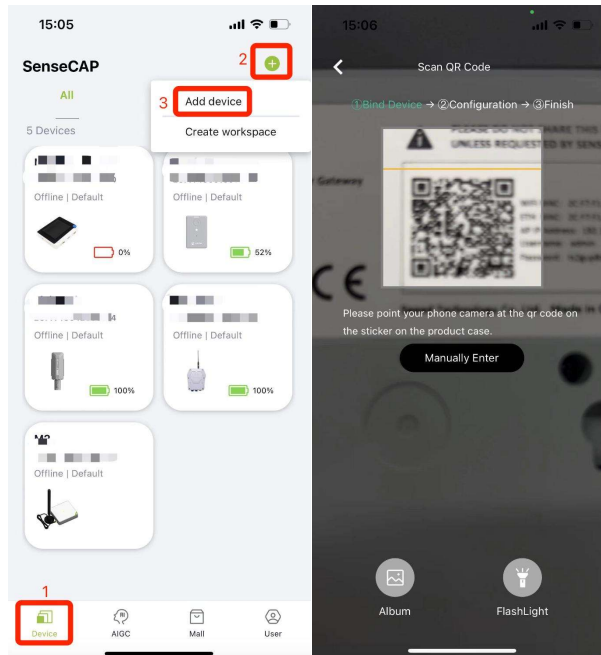

- **Step 2:** Select the frequency plan

Click on "Settings", set the platform and frequency, the frequency should match your gateway frequency.

eg: If your gateway is US915 version , then you need to set your sensor to US915 frequency.

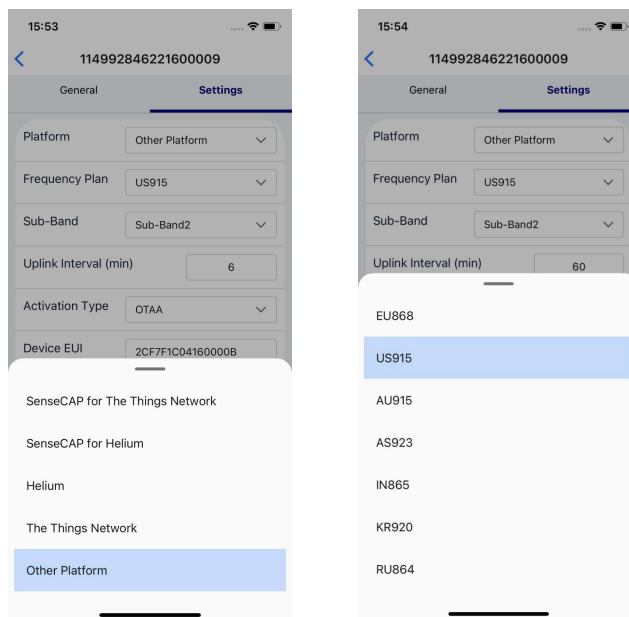

Note: SenseCAP M2 Multi-Platform Gateway can't connect to Helium network.

For more configurations about SenseCAP sensors, please refer to:

[SenseCAP Sensors](#)

4. SenseCAP Portal and Mate APP

SenseCAP Mate APP and SenseCAP Portal can be used to check your device status and device management.

- [SenseCAP Mate APP for iOS](#) on App Store
- [SenseCAP Mate APP for Android](#) on the Google Play Store
- [SenseCAP Portal](#)

4.1 Gateway Info

Check the gateway info on the SenseCAP Portal and SenseCAP Mate APP

SenseCAP Portal

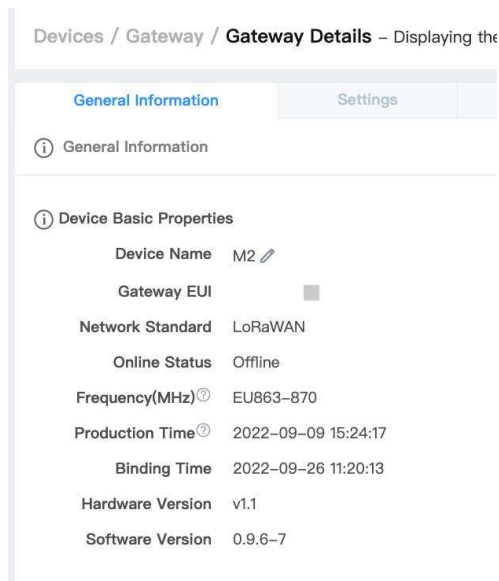

The screenshot shows the 'Gateway Details' page in the SenseCAP Portal. The breadcrumb is 'Devices / Gateway / Gateway Details - Displaying the'. There are two tabs: 'General Information' (selected) and 'Settings'. Under 'General Information', there is a section for 'Device Basic Properties' with the following details:

Device Name	M2
Gateway EUI	
Network Standard	LoRaWAN
Online Status	Offline
Frequency(MHz)	EU863-870
Production Time	2022-09-09 15:24:17
Binding Time	2022-09-26 11:20:13
Hardware Version	v1.1
Software Version	0.9.6-7

SenseCAP Mate APP

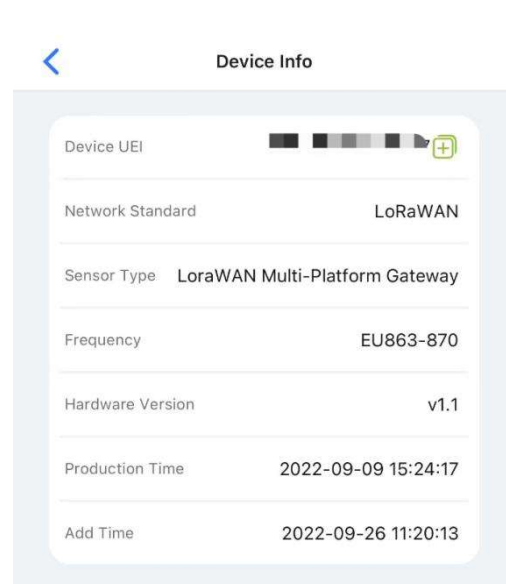

The screenshot shows the 'Device Info' page in the SenseCAP Mate APP. The breadcrumb is 'Device Info'. The page displays the following information:

Device UEI	
Network Standard	LoRaWAN
Sensor Type	LoraWAN Multi-Platform Gateway
Frequency	EU863-870
Hardware Version	v1.1
Production Time	2022-09-09 15:24:17
Add Time	2022-09-26 11:20:13

4.2 Sensor data

Check the sensor data on the SenseCAP Portal and SenseCAP Mate APP

SenseCAP Portal

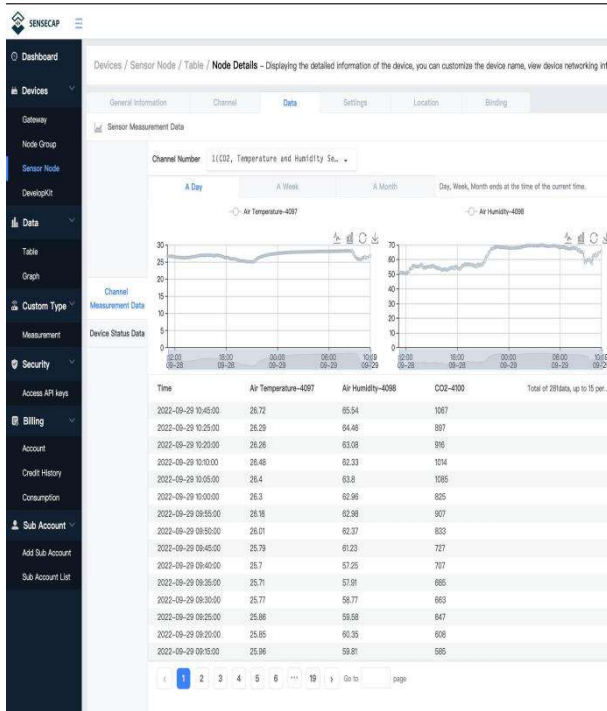

SenseCAP Mate APP

