

Made in France



● Simplify BMS

Installation Guide

Box



Table of contents

Part 1 - Safety Rules	3
EN 60730-1 Power supply considerations:	4
Markings:	5
Part 2 - The Wattsense box - Technical Datasheet	9
Power supply	9
Hardware	9
Interfaces	10
Drivers	10
Software	11
Security	11
Part 3 - Installation Guide	13
Provided material	13
Required material	13
Optional hardware depending on the type of connection	13
Computer access to the Wattsense console	13
The power supply of the box	14
GSM Antenna	18
Antenna Position (USA)	19
To connect the box to the BMS	20
In case of IP network (Except LON)	21
In case of LON IP-852 network	23
To connect the box directly to the technical equipment in the absence of a BMS	25
The equipment communicates in Modbus IP	26
The equipment communicates in Modbus RTU (RS485)	29
The equipment communicates in BACnet IP	34
The equipment communicates in LON IP-852	38
The equipment communicates in LPB	40
The equipment communicates in KNX	41
The equipment communicates in M-BUS	42
To connect the box to LoRaWAN sensors	42
Open Source Software	44
Support	45



Part 1 - Safety Rules:

**Incorrect wiring of this product may damage it and cause other hazards.
The product must be installed by a qualified professional.**

Make sure the product has been wired correctly before turning on the power.

Before wiring, removing, or mounting the product, be sure to turn off the power. Failure to do so may result in electric shock.

Do not touch electrically connected parts, such as power terminals. Doing so may result in electric shock.

Do not disassemble the product. Doing so may result in electric shock or malfunction. Use the product within the operating ranges recommended in the specifications (temperature, humidity, voltage, shock, mounting direction, atmosphere, etc.) Failure to do so may result in fire or malfunction.

Tighten the electrical wires on the connector. Insufficient tightening of the wires on the terminal may cause a fire.

Disconnect the power supply before installation or maintenance to avoid electric shock or property damage.

Use only copper conductors. Make all connections in accordance with local, state, and national electrical codes.

To reduce the risk of fire or electric shock, install the equipment in a controlled environment relatively free of contaminants.

This equipment is intended for use as a monitoring and control device only. To avoid loss of data or damage to the equipment, do not use it for any other purpose.

The cover or front panel of the device should not be removed. No configuration or maintenance action of the components (e.g. jumpers or battery) by the user requires the removal of the cover; all elements are accessible as connectors on the top, bottom, and side of the device.

The device must be mounted on a DIN rail in a cabinet or in an electrical box.

When the device is mounted inside an enclosure, make sure the enclosure is designed to maintain the required operating temperature range (allowing for 24 watts of dissipation by the controller). This is especially important if it is mounted inside an enclosure with other heat-producing equipment.

This device is intended for indoor use only.

Do not install the device in an area:

- Where there is excessive moisture, corrosive fumes, or explosive vapors,
- Where vibration or shock is likely to occur,
- Subject to electrical noise, e.g. near large electrical contractors, electrical machinery, welding equipment, etc.

This equipment is not suitable for use in areas where children may be present.

The device is not compatible with a Power-Over-Ethernet (POE) network. Connecting it to a network segment carrying power may cause a failure. In this case, you must disconnect the device from the POE network segment, turn it off and on again.

To avoid any risk of injury caused by a fall, the device should not be installed more than 2 meters from the ground.

EN 60730-1 Power supply considerations:

- Electrical safety in building automation and control systems relies primarily on the use of extra-low voltage, strictly separated from the mains voltage. This low voltage is either SELV or PELV, according to EN 60730-1.
- Protection against electric shocks is ensured by the following measures:
 - Voltage limitation (low voltage supply DC 24V DC +/-10%, SELV or PELV),
 - Protective separation of the SELV system from all circuits other than SELV and PELV,
 - Simple separation of the SELV system from other SELV systems, PELV systems and the ground.
- Field devices such as sensors, status contractors, or actuators connected to the low voltage inputs and outputs of the I/O modules must comply with SELV or PELV requirements. Interfaces to field devices and other systems must also comply with SELV or PELV requirements.
- When power for SELV or PELV circuits is obtained from higher voltage power systems, it shall be provided by a safety transformer or converter designed for continuous operation to power the SELV or PELV circuits.

● Markings:



Disposal and recycling

Electrical and electronic equipment may not be disposed of with household waste. This also applies to products that do not carry this logo. Electrical and electronic equipment contain materials and substances that can harm the environment and human health. At the end of their life, electrical and electronic equipment must therefore be disposed of in an appropriate way. The European WEEE Directive 2012/19/EU applies throughout the European Union. The directives and laws that transpose it into national law may vary from country to country. Environmentally sound disposal is good for your health and protects the environment from harmful substances in electrical and electronic equipment.

- Observe national and local regulations regarding the disposal of electrical and electronic equipment.
- Erase all data stored on electrical and electronic equipment.
- Drop off or send your electrical and electronic equipment to your local specialized collection point

This symbol is only valid in the European Union please contact your local authorities or dealer and ask for the correct method of disposal



CE Marking

Wattsense declares that this device is manufactured in accordance with the technical specifications of the product and is in compliance in all respects with the relevant standards and regulations



FCC-IC Compliance Statement

FCC ID : 2A2KQ-WSGW1

This equipment has been tested and found to comply with the limits for a Class B digital device, pursuant to part 15 of the FCC Rules. These limits are designed to provide reasonable protection against harmful interference in a residential installation. This equipment generates, uses and can radiate radio frequency energy and, if not installed and used in accordance with the instruction, may cause harmful interference to radio communications. However, there is no guarantee that interference will not occur in a particular installation. If this equipment does cause harmful interference to radio or television reception which can be determined by turning the equipment off and on, the user is encouraged to try to correct interference by one or more of the following measures

- Reorient or relocate the receiving antenna.
- Increase the separation between the equipment and receiver.
- Connect the equipment into an outlet on circuit different from that to which the receiver is connected.
- Consult the dealer or an experienced radio/TV technician for help.



WARNING : This product is only to be installed by qualified personnel.

Cellular RF

This device contains a cellular RF module with FCC ID : 2AJYU-8PYA004

This device contains a cellular RF module with IC : 23761-8PYA005

FCC Caution:

- 1 Exposure to Radio Frequency Radiation. This equipment must be installed and operated in accordance with provided instructions and the antenna(s) used for this transmitter must be installed to provide a separation distance of at least 20 cm from all persons and must not be collocated or operating in conjunction with any other antenna or transmitter. End-users and installers must be provided with antenna installation instructions and transmitter operating conditions for satisfying RF exposure compliance.
- 2 Any changes or modifications not expressly approved by the grantee of this device could void the user's authority to operate the equipment.
- 3 This transmitter must not be co-located or operating in conjunction with any other antenna or transmitter.
- 4 Changes or modifications to this unit not expressly approved by the party responsible for compliance could void the user authority to operate the equipment.

The cellular antenna delivered by Wattsense meets the FCC-IC regulations. If the installer makes the choice to use another antenna, it must follow the specifications listed below for the device used to comply with FCC/IC regulations limiting both maximum RF output power and human exposure to RF radiation.

- 1 Whip antenna type
- 2 50 Ohm typical impedance
- 3 Maximum antenna gain

Frequency Band	Antenna Gain (dBi)
GSM850	-1
GSM1900	6
GPRS850 4TS	-1
GPRS1900 4TS	6
WCDMA Band2	10
WCDMA Band4	9
WCDMA Band5	7
LTE Band2	10
LTE Band4	11
LTE Band5	7
LTE Band7	10
LTE Band12	6
LTE Band13	6
LTE Band25	10
LTE Band26	8
LTE Band41	9
LTE Band66	9



LoRaWAN RF

This device contains a cellular RF module with FCC ID : 2AJYU-8PYA004

This device contains a cellular RF module with IC : 23761-8PYA005

FCC Warning: This device complies with part 15 of the FCC Rules. Operation is subject to the following two conditions.

- (1) This device may not cause harmful interference.
- (2) This device must accept any interference received, including interference that may cause undesired operation.

Any changes or modifications not expressly approved by the party responsible for compliance could void the user's authority to operate the equipment.

This module complies with FCC radiation exposure limits set forth for an uncontrolled environment .This equipment should be installed and operated with minimum distance 20 cm between the radiator & your body.

The LoRaWAN antenna delivered by Wattsense meets the FCC-IC regulations. If the installer makes the choice to use another antenna, the maximum antenna gain allowed is 5.8 dBi to comply with FCC/IC regulations limiting both maximum RF output power and human exposure to RF radiation.

CAN ICES-003 Compliance

This device complies with FCC and ISED RF radiation exposure limits set forth for general population. This device must be installed to provide a separation distance of at least 20cm from all persons and must not be co-located or operating in conjunction with any other antenna or transmitter.

This radio transmitter (23761-8PYA005 and 25908-RAK2247) has been approved by Industry Canada to operate with the antenna types listed below with the maximum permissible gain and required antenna impedance for each antenna type indicated. Antenna types not included in this list, having a gain greater than the maximum gain indicated for that type, are strictly prohibited for use with this device.

This device contains license-exempt transmitter(s)/receiver(s) that comply with Innovation, Science and Economic Development Canada's licence-exempt RSS(s). Operation is subject to the following two conditions:

- 1 This device may not cause interference, and
- 2 This device must accept any interference, including interference that may cause undesired operation of the device.

Cellular antenna characteristics

- 1 Whip antenna type
- 2 50 Ohm typical impedance
- 3 Maximum antenna gain



LoRaWAN antenna characteristics

Gain: 5.8dB

Frequency Band	Antenna Gain (dBi)
GSM850	-1
GSM1900	6
GPRS850 4TS	-1
GPRS1900 4TS	6
WCDMA Band2	10
WCDMA Band4	9
WCDMA Band5	7
LTE Band2	10
LTE Band4	11
LTE Band5	7
LTE Band7	10
LTE Band12	6
LTE Band13	6
LTE Band25	10
LTE Band26	8
LTE Band41	9
LTE Band66	9

Radio common informations

GSM / GPRS / EDGE



850/900/1800/1900MHz 33dBm

LTE



850/900/1800/1900MHz 23dBm

LoRaWAN



WSG-EU-SC-14-00

WSG-NA-SC-14-00

EU868MHz

EU 915MHz / AS1 923MHz /
AS2 923MHz

14dBm

14dBm



● Part 2 - Technical Datasheet

The Tower and the Bridge rely on the exact same electronic device:

- Created to connect all equipment from all buildings: IoT sensors, meters, heating, air conditioning, air handling systems, building management systems (BMS)
- Easy and quick to install: accessible for all. If the building already has a BMS, the box connects to the main bus as the third party. If there's no BMS, a BMS network is directly created by the box.
- Telemetry and controls: collects data and controls equipment.
- Smart Converter: unifies the field communication protocols.
- Web-Connected: automatically connects to the cloud via 3G/4G or ethernet cable.
- Powerful IoT device: combines the functionality of a gateway, a PLC, a modem, and an edge device.

● Power supply

- Stabilized power supply input: 85-264 V AC output: DC 24 V +/-10% / 2 A
- The cable between the power supply and the device: 2 wires (red, black), 22 AWG, minimum section: 0.35 mm².
- Protection against overvoltage, undervoltage, and overcurrent from the power supply with indication by LED: green LED when the power supply is compatible, red LED if it is not suitable.

● Hardware

CPU	528MHz ARM Cortex A7
Memory	512MB RAM
Storage	4GB Flash
Consumption	5W
Dimension	160 × 110 × 55 mm (without antennas) 160 × 110 × 95 mm (with antennas)
Weight	350g - 385g with antenna
Operating temperature	From 0°C to +45°C
Humidity	5% to 95% humidity - No condensation
IP Code	IP2X
Mounting	-DIN rail Omega profile (TN35) DIN 1015 / 1070 / 3070- Wall mounted (2 screws)

Interfaces

Type of interface	Quantity	Operating LEDs	
Cellular modem	1	Yes	<ul style="list-style-type: none"> ● Not connected ☀ every 1.2s Connected ☀ every 0.4s Communicating
LoRaWAN module from 863MHz to 928MHz	1	No	
Ethernet RJ45	2	Yes	<ul style="list-style-type: none"> ● Communicating ● Not communicating
RS485	2	Yes	<ul style="list-style-type: none"> ● Communicating ● Not communicating
USB	2	No	
USB Micro	1	No	
KNX	1	Yes	<ul style="list-style-type: none"> ● Communicating ● Not communicating
M-Bus	1	Yes	<ul style="list-style-type: none"> ● Communicating ● Not communicating
LPB/BSB (X-Bus)	1	Yes	<ul style="list-style-type: none"> ● Communicating ● Not communicating

Protection of communication bus against ESD, short circuit, overconsumption.

Other LEDs

Power Supply	1	Yes	<ul style="list-style-type: none"> ● Power supply OK ● Power supply NOK
Heartbeat	1	Yes	<ul style="list-style-type: none"> ☀ Box working ● Box not working

Drivers

- BACnet IP
- BACnet IP Server
- Diematic
- KNX S et LTE
- LON IP-852
- LPB
- LoRaWAN 1.0 Local private - Frequency plans supported:
WSG-EU-SC-00-14 : EU863-870, IN865-867
WSG-NA-SC-00-14 :US902-928, AS923-925, AU915-928
- M-Bus (3UL Max.)
- Modbus RTU
- Modbus TCP/IP
- Modbus TCP/IP Server
- MQTT Client



Software

- Secured Linux Yocto distribution.
- Built-in drivers for all buses, protocols, and building equipment.
- Automatic discovery of equipment on BACnet.
- Remote and automated configuration.
- Secure server communication via MQTT.
- Automatic and secure software updates.
- LoRaWAN server remote backup.

Security

Enterprise-grade security based on SSL/TLS with the following properties:

- Two-way authentication between box and server with x509 certificates.
- End-to-end encryption.
- Message integrity checks.

Data frequency

Data is read by default at a 10-minute interval, excluding IoT sensors that have their own frequencies to minimize battery consumption. Commands (downlink) are sent instantly.



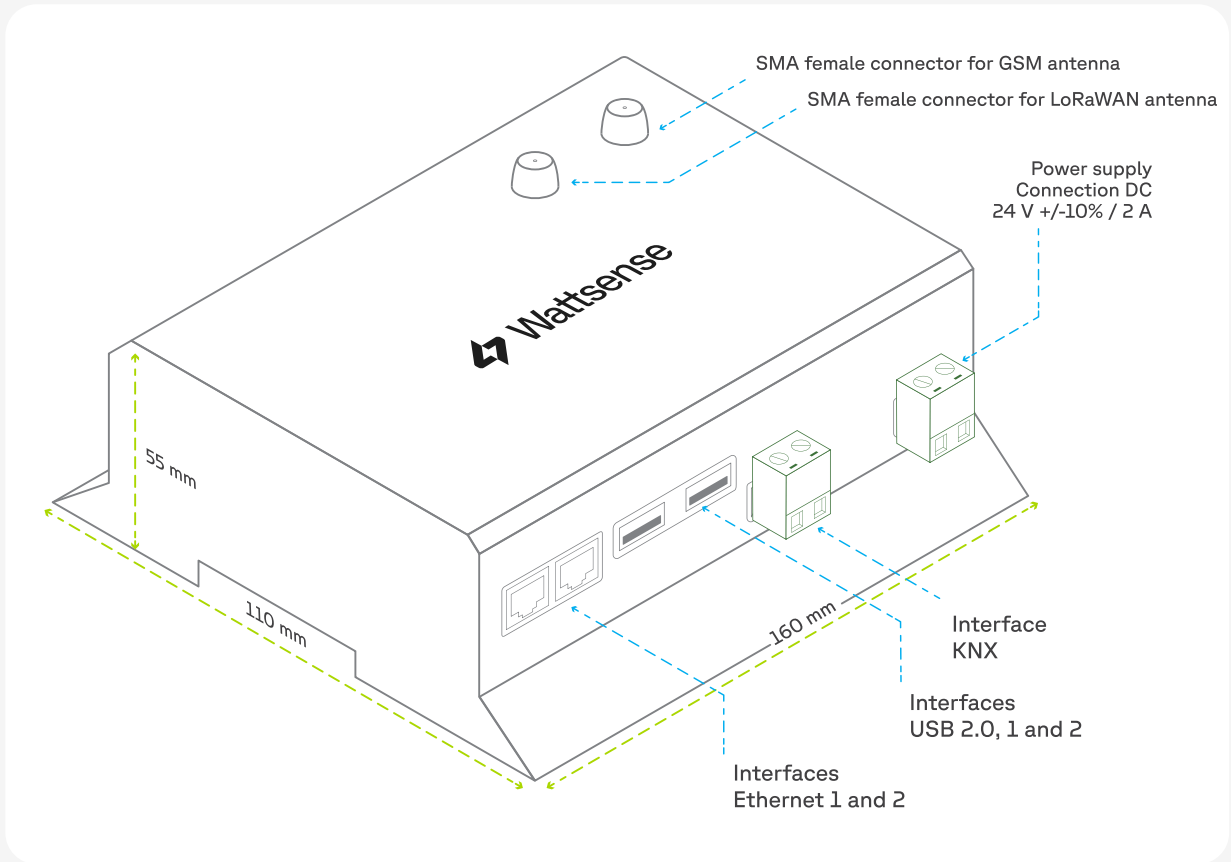
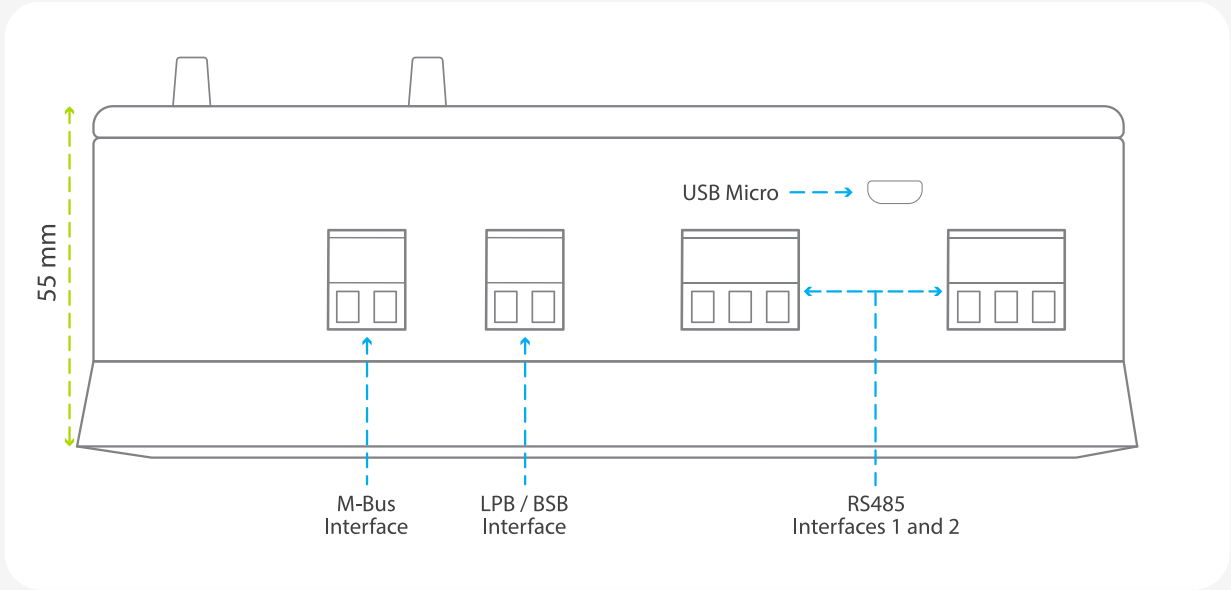

● Part 3 - Installation Guide

What do you need before starting?

● Provided material

1. Box
Dimensions: 160 x 110 x 55 mm (without antennas)
Weight: 350 g - 385 (with antennas)
2. GSM standard antenna
3. LoRa standard antenna
4. Info card

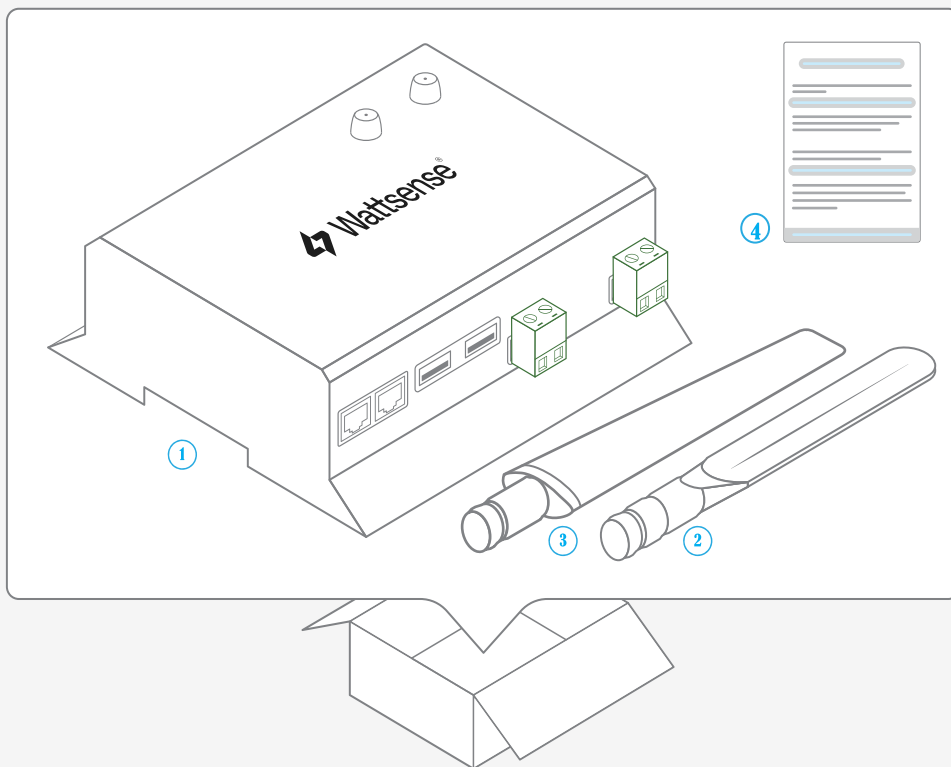

● Required material

- Stabilized power supply input: 85-264 V AC output: DC 24 V +/-10% / 2 A
- Cable between the power supply and the device: 2 wires (red, black), 22 AWG or 0.35 mm²
- Flat screwdriver
- Cutting pliers
- Wire stripper

● The power supply of the box

Make sure that the device has been activated beforehand on the user console.

- Ideally, place the box in an electrical enclosure or cabinet.
- This type of equipment is not suitable for installation in places that can accommodate children.
- Attach the box:

Mount the box on a DIN rail

Push the RAIL DIN lock

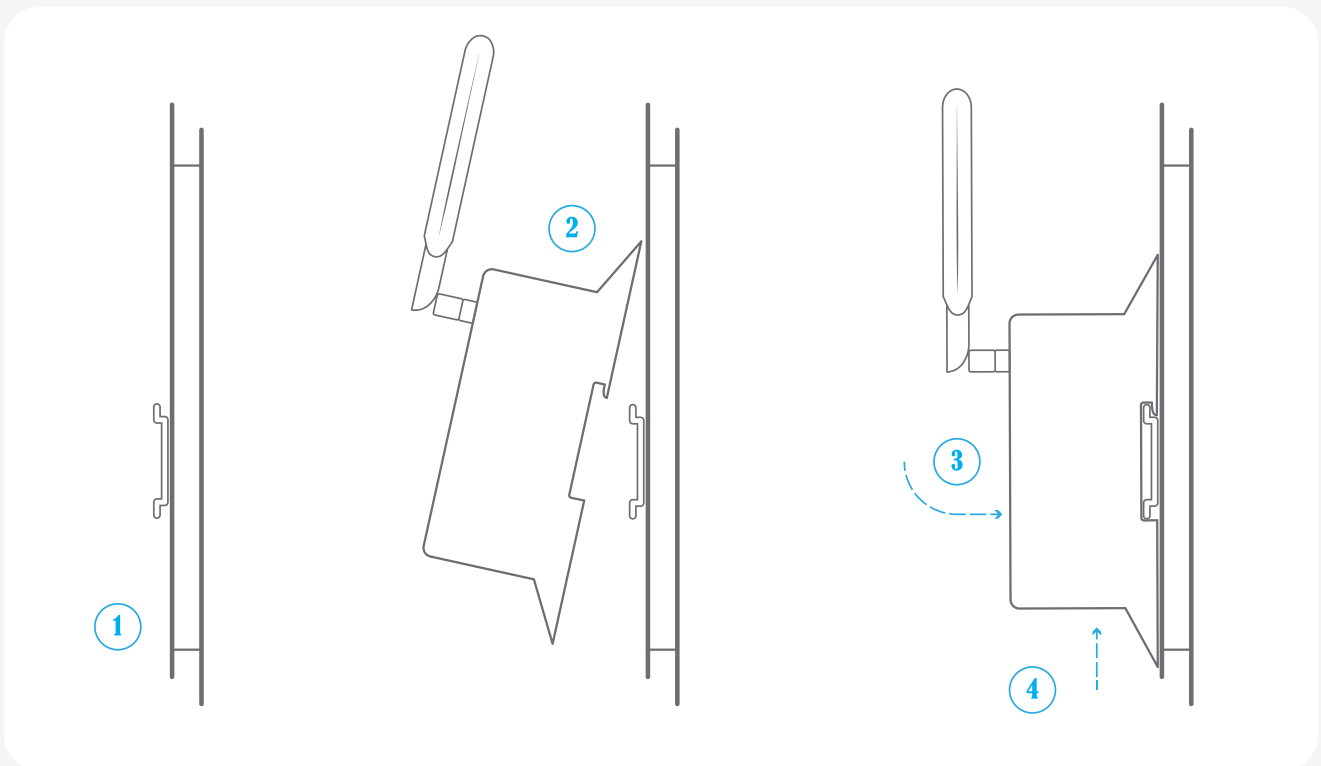

- To avoid any risk of injury caused by a fall, the box should not be installed more than 2 meters from the ground.
- Use a stabilized power supply input: 85-264 V AC output: DC 24 V +/-10% / 2 A
- Attach crimping ferrules to both wires
- Screw the cable into the power connector of the box

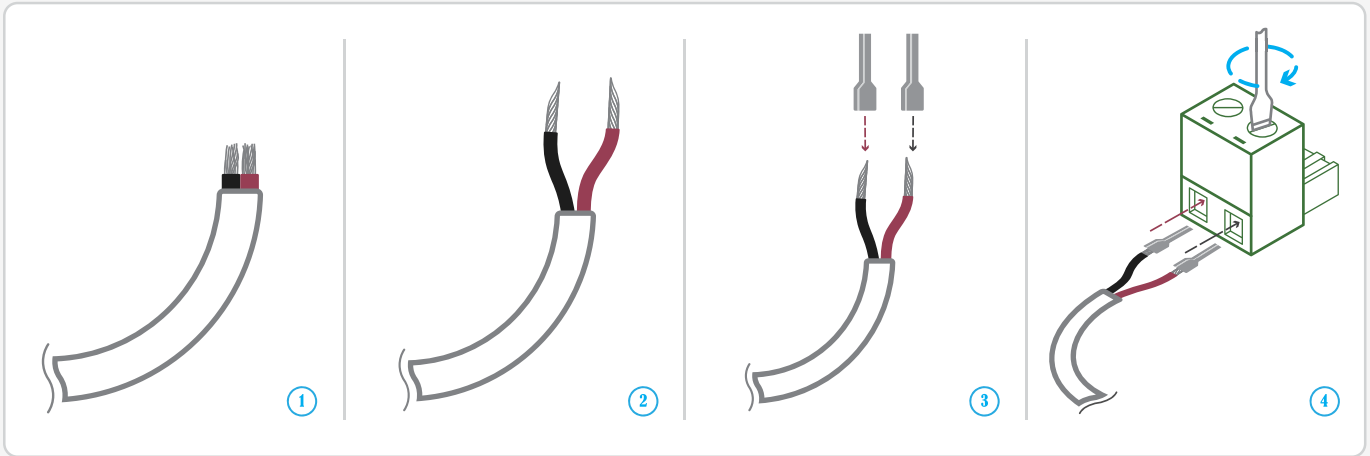

- Connect the cable to the power supply.

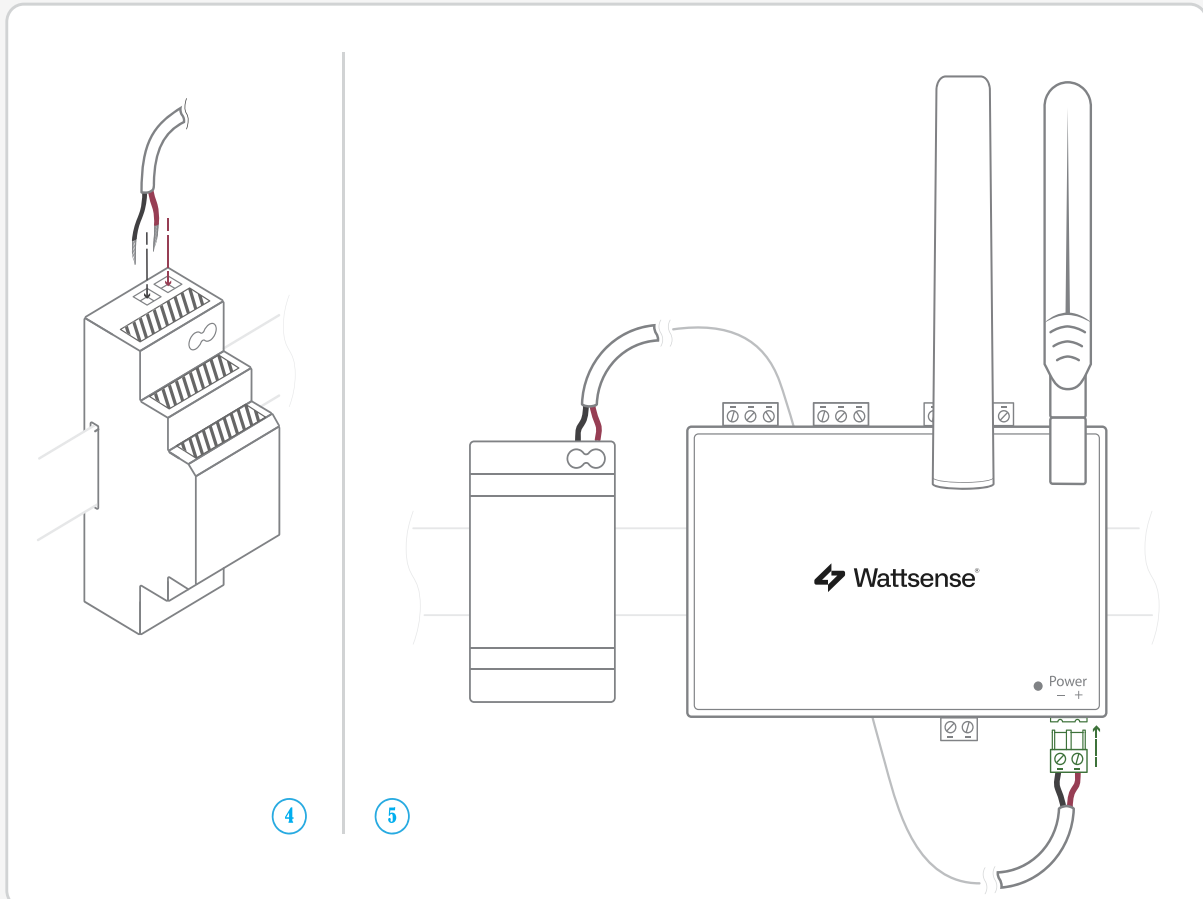

- Check that the "Power" LED is lit (steady green light).

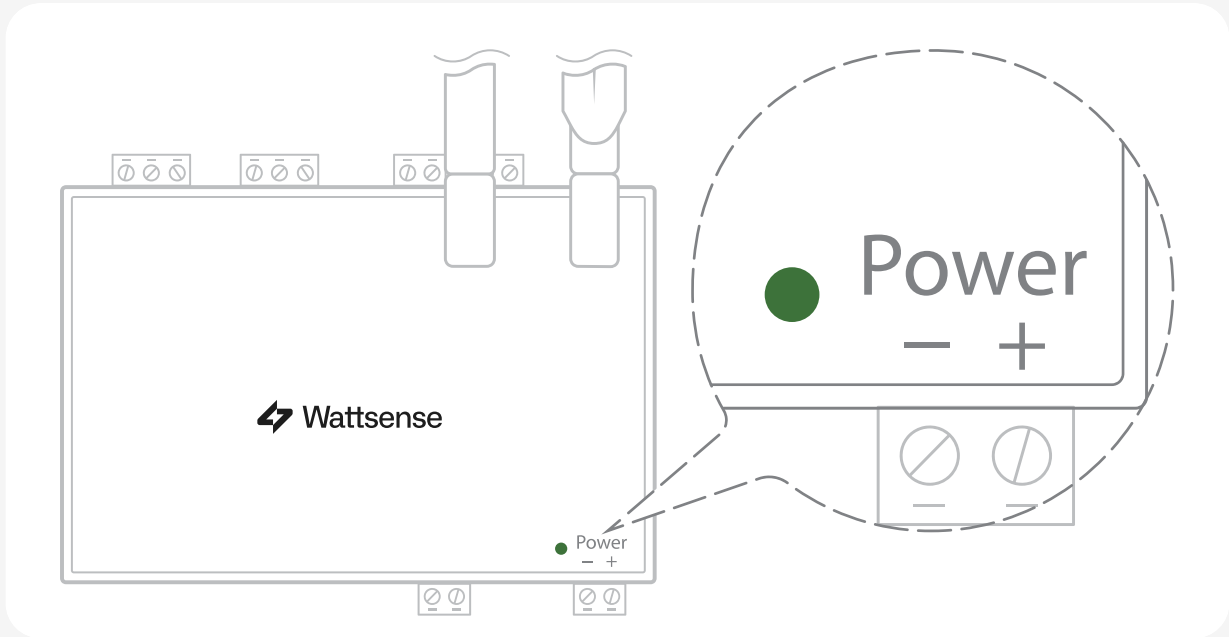

- Wait about 10 seconds: the "Heartbeat" LED flashes (green light).

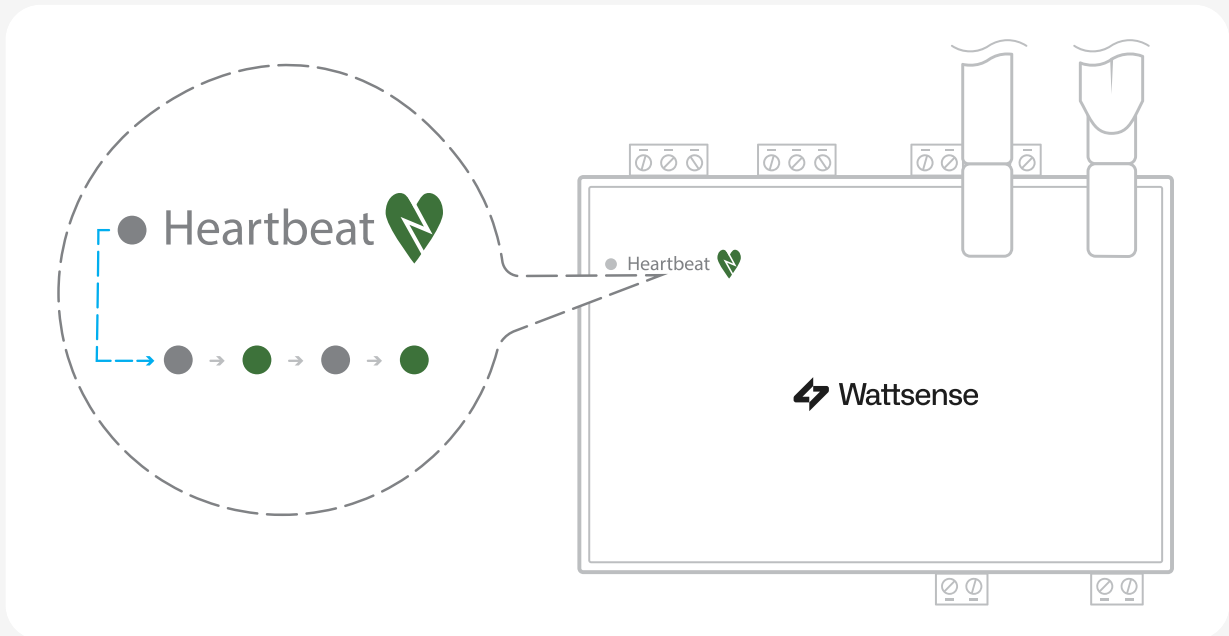

- Wait until the GSM LED flashes; if the LED does not flash after a few minutes, see the chapter of the GSM antenna.

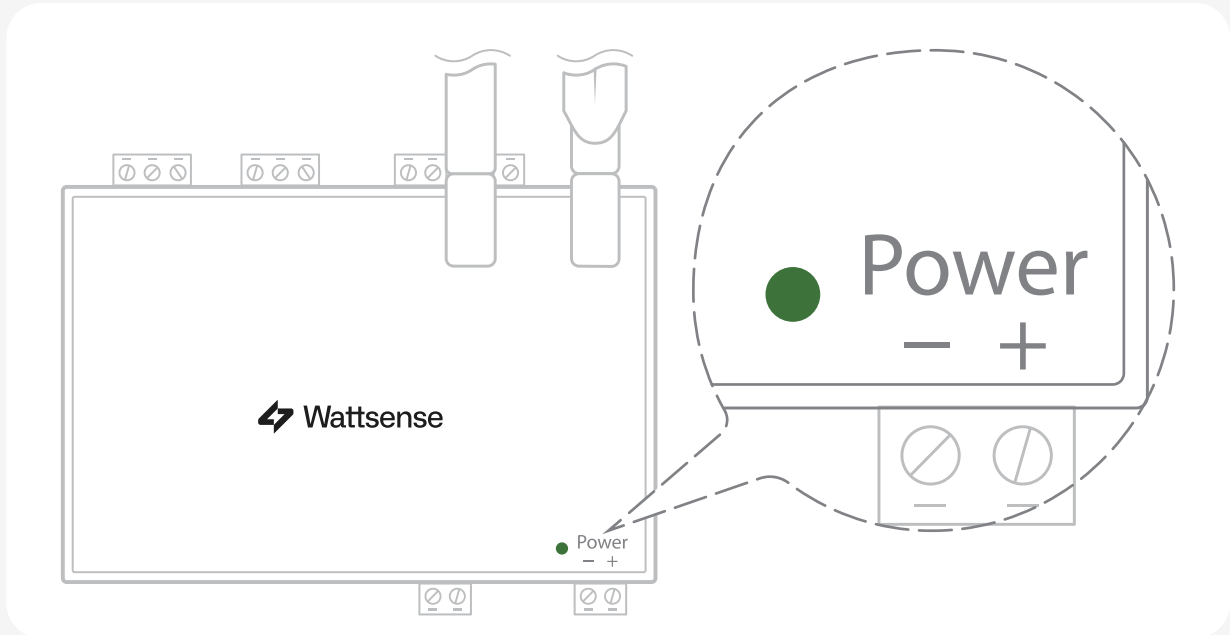

- Check that the box appears on the console: the presence indicator of the box changes from red to green.
- If the box appears on the console, it is functional; you can go to the connection step of the box to the equipment and/or the network of the building.
- If the box does not appear on the console, see the GSM Antenna chapter.

GSM Antenna

The box is supplied with a standard GSM antenna.

For the United States, please use an antenna with a gain not exceeding that shown in the table below:

Frequency Band	Antenna Gain (dBi)
GSM850	-1
GSM1900	6
GPRS850 4TS	-1
GPRS1900 4TS	6
WCDMA Band2	10
WCDMA Band4	9
WCDMA Band5	7
LTE Band2	10
LTE Band4	11
LTE Band5	7
LTE Band7	10
LTE Band12	6
LTE Band13	6
LTE Band25	10
LTE Band26	8
LTE Band41	9
LTE Band66	9

- If the quality of the GSM signal is good: keep the original antenna installed on the box.

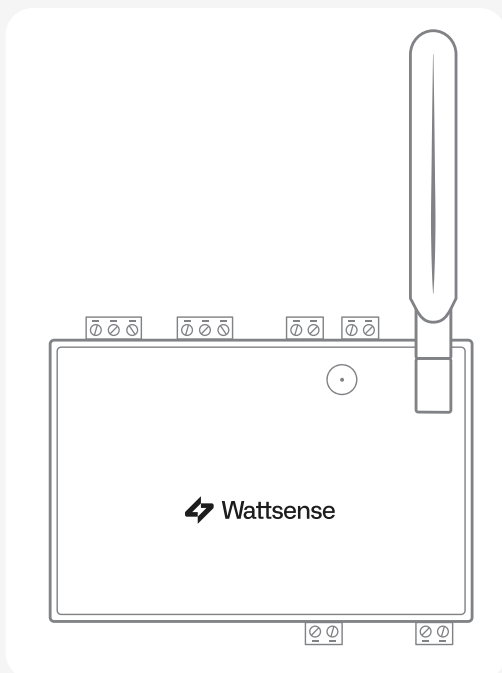

- If the signal quality is insufficient: move the original antenna out of the cabinet; use an RF extension cord with SMA connector, up to 2 meters, + 1 adhesive support to hold the antenna.
- If the signal quality is still insufficient: use a high-gain antenna with a maximum of 10 meters of cable; this antenna can, for example, be moved to the outside or to the other floors to obtain a better signal quality. Please note that, beyond 15 meters of cable, the GSM signal is significantly weakened.

● Antenna position (USA)

For an installation in the United States of America, the GSM antenna and the LoRa antenna must be positioned at 90° to each other.

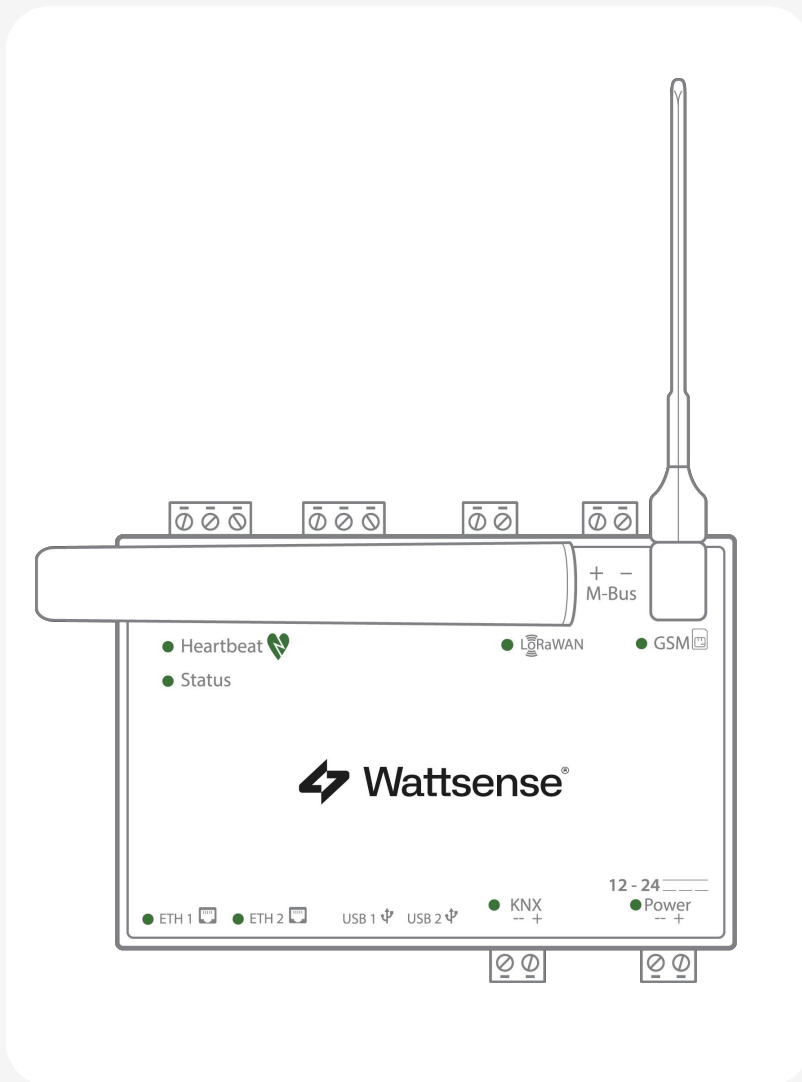

To connect the box to the BMS

- Determine the type(s) of network(s) associated with the BMS (communication protocols between the BMS server and the technical equipment).
- Obtain, if possible, the schematic of the communication network(s) of the BMS.
- Identify where and how the BMS server connects to the building's network.

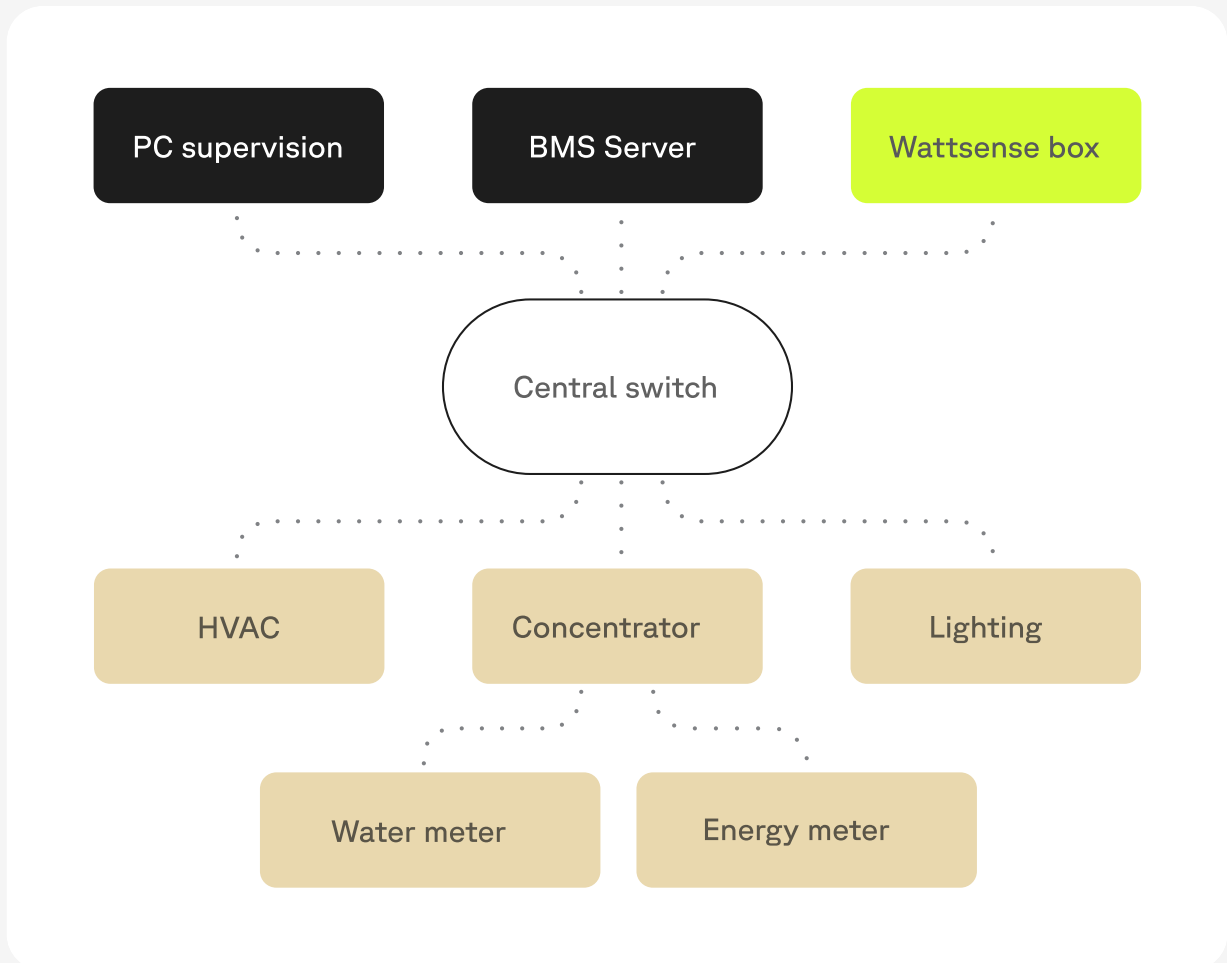

● In case of IP network (Except LON)

Connection:

- Make sure to have an Ethernet cable.
- Connect the cable to the Ethernet port of the box ETH1 or ETH2.

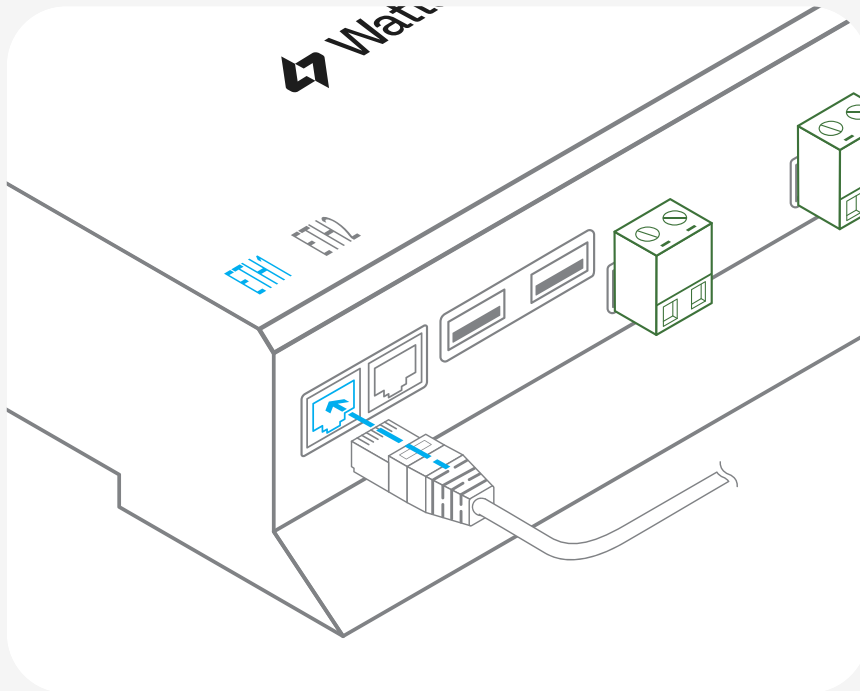

- Connect the box to the switch (IP network) on which the supervision PC/BMS server is connected.
- Check that the ETH1 or ETH2 LED lights up.

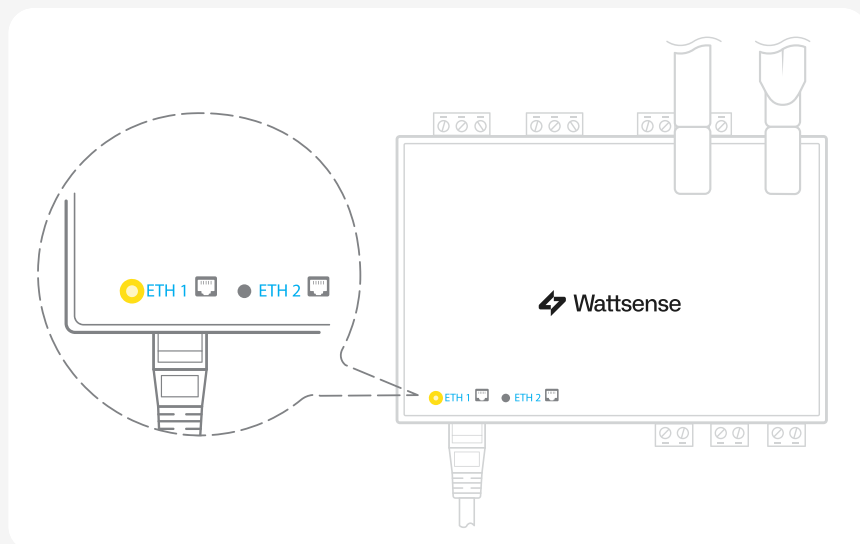

Configuration:

- If there is no DHCP server on the network, attribute a static IP address, its mask and the gateway if necessary to the box (Discuss with the building's IT manager).
- If there is a DHCP server on the network, the address is automatically assigned.

Information to retrieve in preparation for the configuration:

- For each device that communicates in Modbus IP
 - From the BMS software, perform an extract of the available properties: list the data types provided by the different devices to which the BMS has access.
 - If it is impossible to retrieve this information, get the IP address and TCP port (and if needed, for some devices, the slave address (Slave ID), the brand, and model of the equipment, and extra identifying information. This information is necessary for the installation configuration and to retrieve data.
- In the case of a BACnet IP network
 - Write down the BACnet port of the network. This information will be necessary for the installation configuration and to retrieve data.



● In case of LON IP-852

Connection:

- Make sure to have an Ethernet cable
- Connect the cable to the Ethernet port of the box ETH1 or ETH2.

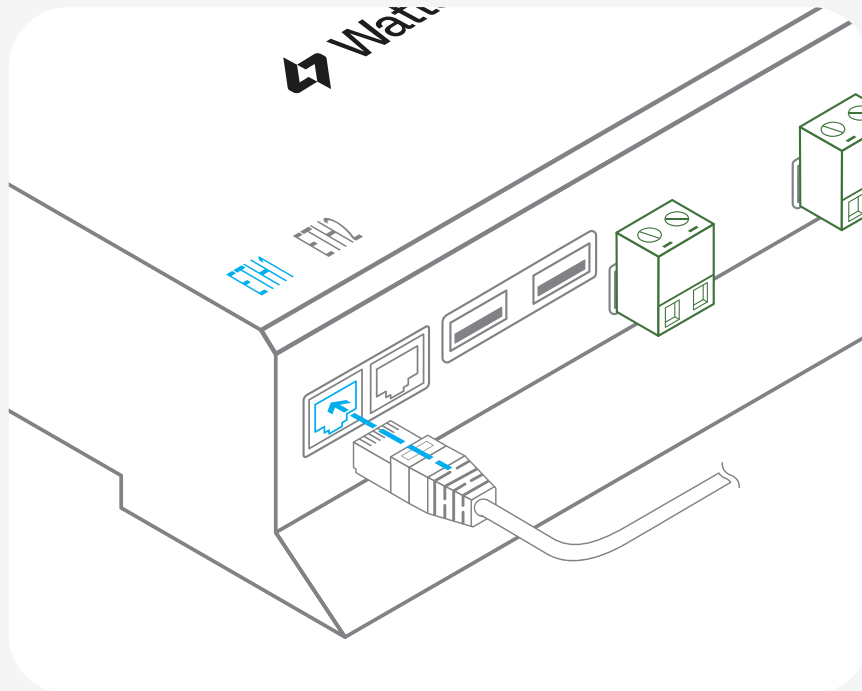

- Connect the other end of the cable to the IP-852 server on the LON network.

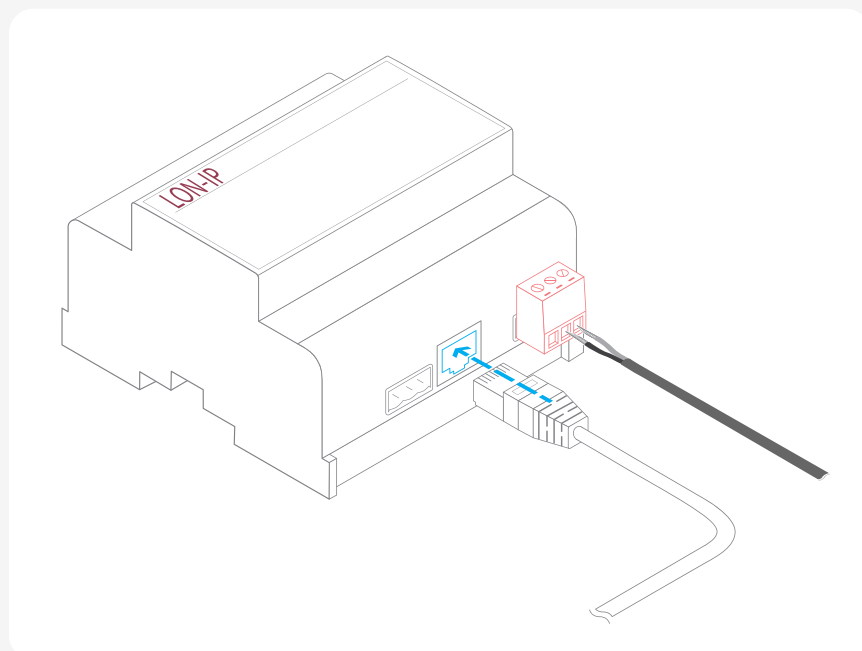

- Verify that the ETH1 or ETH2 LED lights up

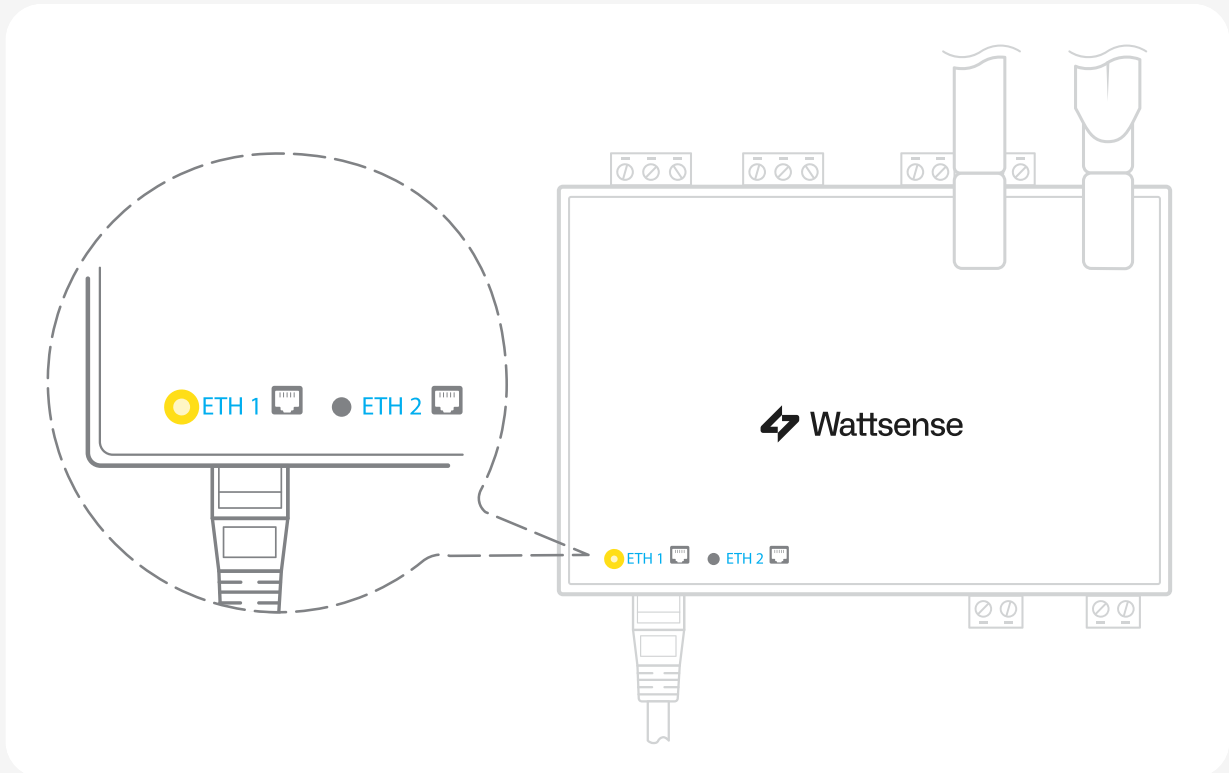

- Register the IP address of the box on the IP-852 server of the LON network; the IP-852 server's password is probably required.

Information to retrieve in preparation for the configuration phase:

- Write down the Neuron-ID, brand and model of the equipment, and any identifying information. This information will be necessary for the installation configuration and to retrieve data.
- If you have the NL220 software, export the LON database as an archive file or as an NLC file.

● To connect the box directly to the technical equipment in the absence of a BMS

- Prepare the list of equipment to be connected and their respective communication protocols.
- Collect the technical documentation of each manufacturer to know where and how to connect to its devices (user console, configuration wizard, manufacturer's site, etc.).
- Draw up an installation schematic.

• The equipment communicates in Modbus IP

To connect only one equipment

- Make sure to have an Ethernet cable.
- Connect the cable to the Ethernet port ETH1 or ETH2.

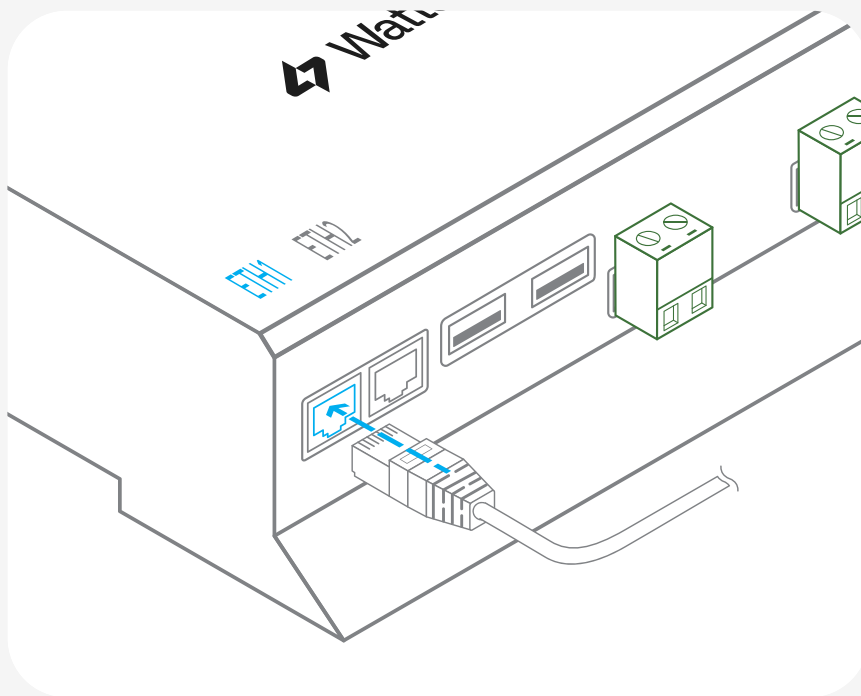

- Connect the other end of the cable to the equipment.
- Verify that the ETH1 or ETH2 LED lights up.

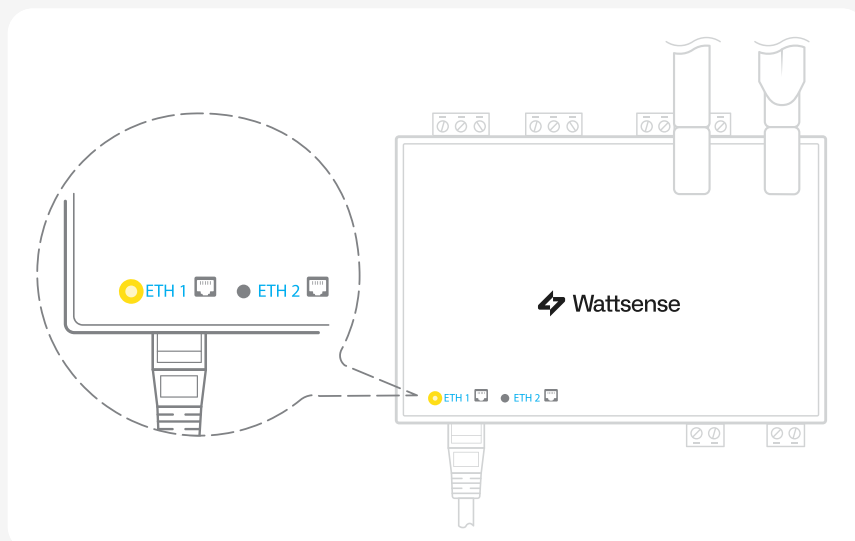

To connect two devices

- Make sure to have 2 Ethernet cables.
- Connect the cables to the Ethernet ports of the box ETH1 and ETH2.

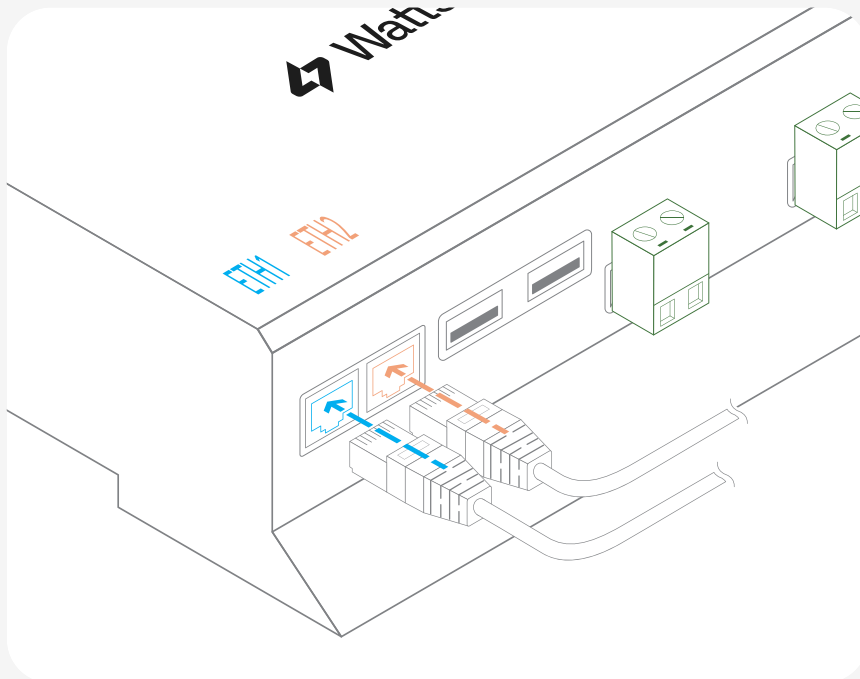

- Connect the cables to the 2 Modbus devices.
- Check that the ETH1 and ETH2 LEDs light up.

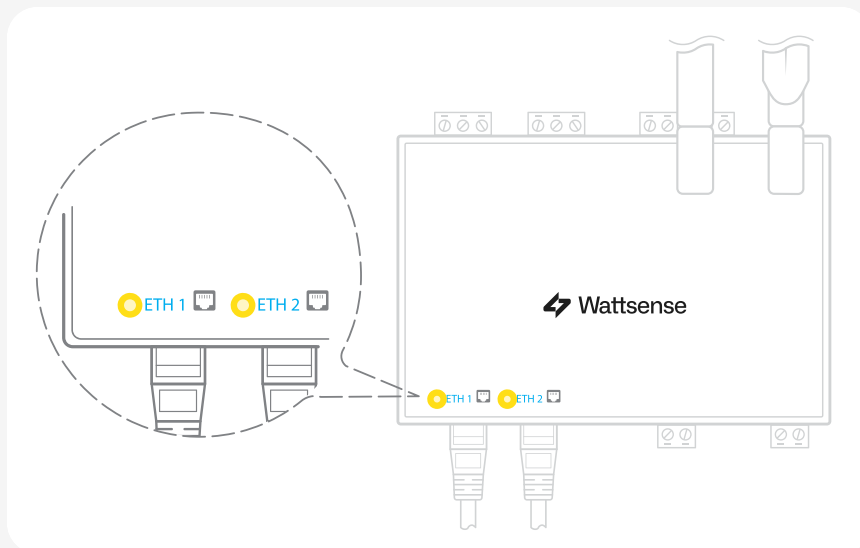

To connect three equipment or more make sure to:

- Have an Ethernet cable for the box.
- Have as many Ethernet cables as equipment to connect.
- Have an Ethernet switch.
- Connect the switch to the power supply

- Connect an Ethernet cable to the Ethernet port of the box ETH1 or ETH2.

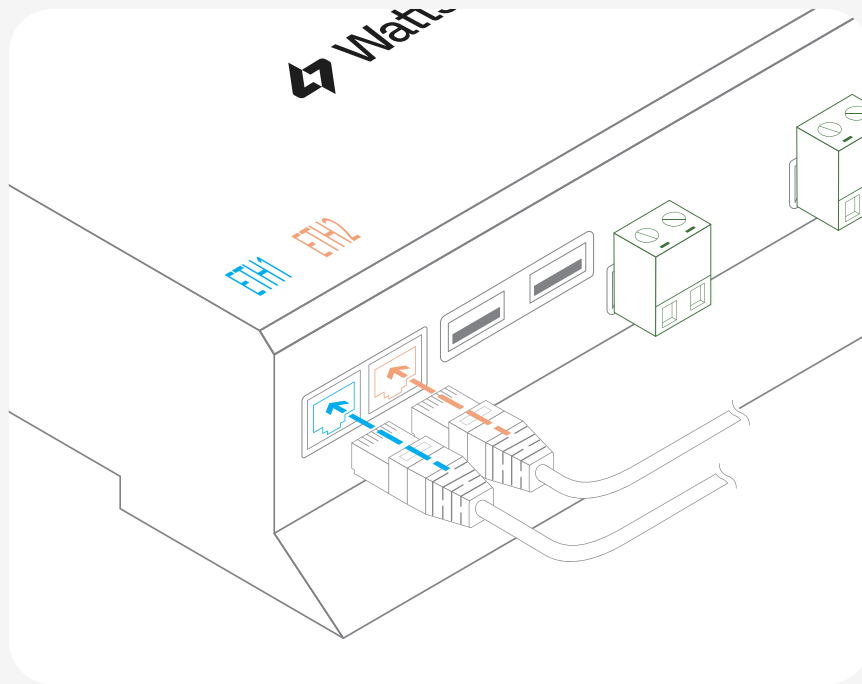

- Connect the other end of this cable to the Ethernet switch.

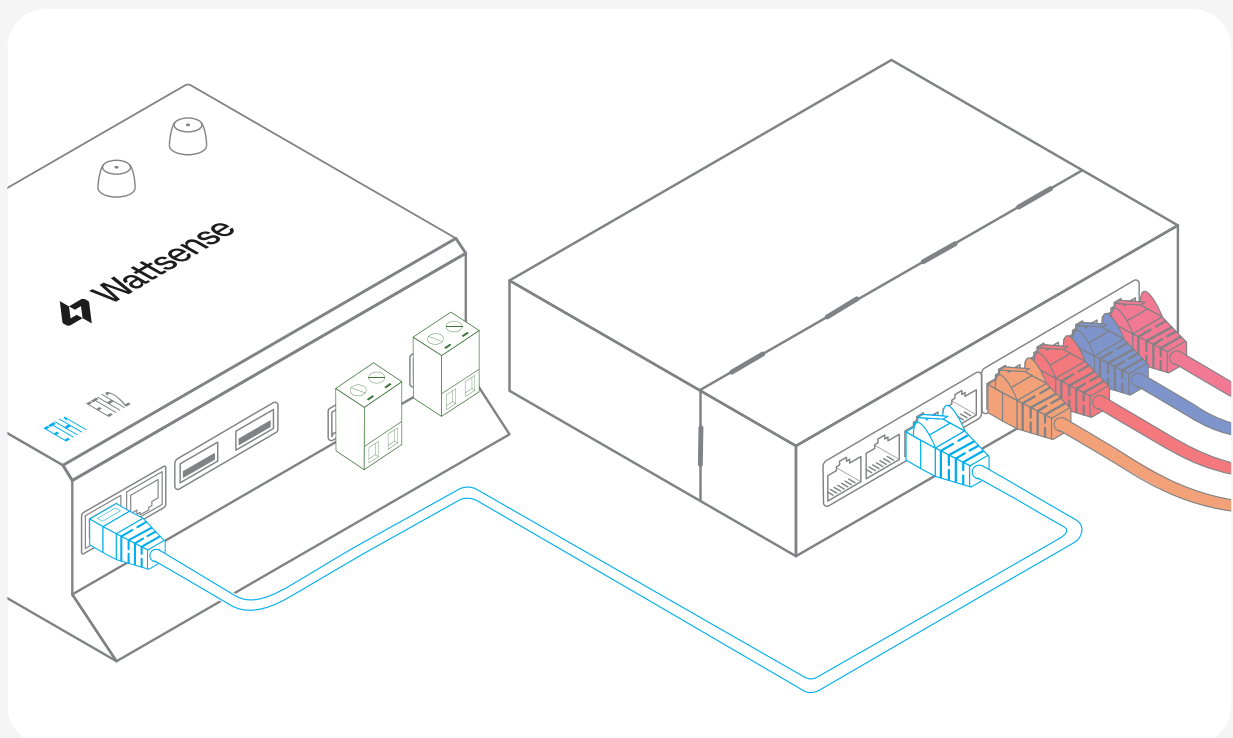

- Check that the ETH1 or ETH2 LED lights up.

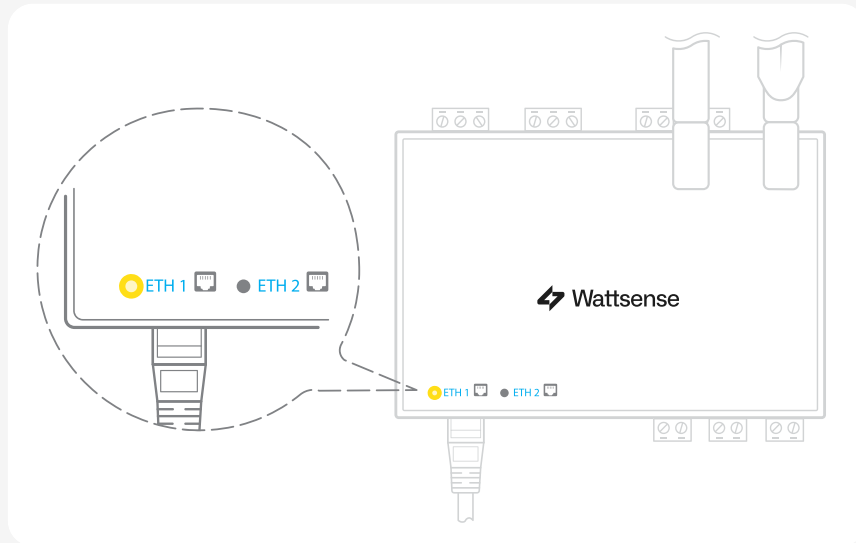

- Connect all equipment to the switch via the Ethernet cables.

To configure each one of the equipment:

- Using the technical documentation of the equipment, find its IP address and TCP port (and if necessary, for some devices, the address of the slave "Slave ID").
- If the equipment does not have an IP address, assign one to it, 192.168.1.1 for the first device, then 192.168.1.2 for the second device, 192.168.1.3 for the third device, and so on.
- Write down the IP address and TCP port (and if necessary, for certain devices, the address of the Slave ID), the brand and model of the equipment, and any information that allows it to be identified. This information will be necessary for the installation configuration and to retrieve data.

• The equipment communicates in Modbus RTU (RS485)

Organization of the Bus architecture:

- Gather the necessary information for each device: Bus speed, character size, parity bit, stop bit (from the user console's configuration wizard, from the manufacturer's technical documentation, or directly from the control panels of the equipment).
- The goal is to create a maximum of two networks, each grouping equipment with the same communication configuration and assign them to the two RS485 ports of the box.
- If the characteristics of the equipment require to set more than two homogeneous networks, it is necessary to order another box.

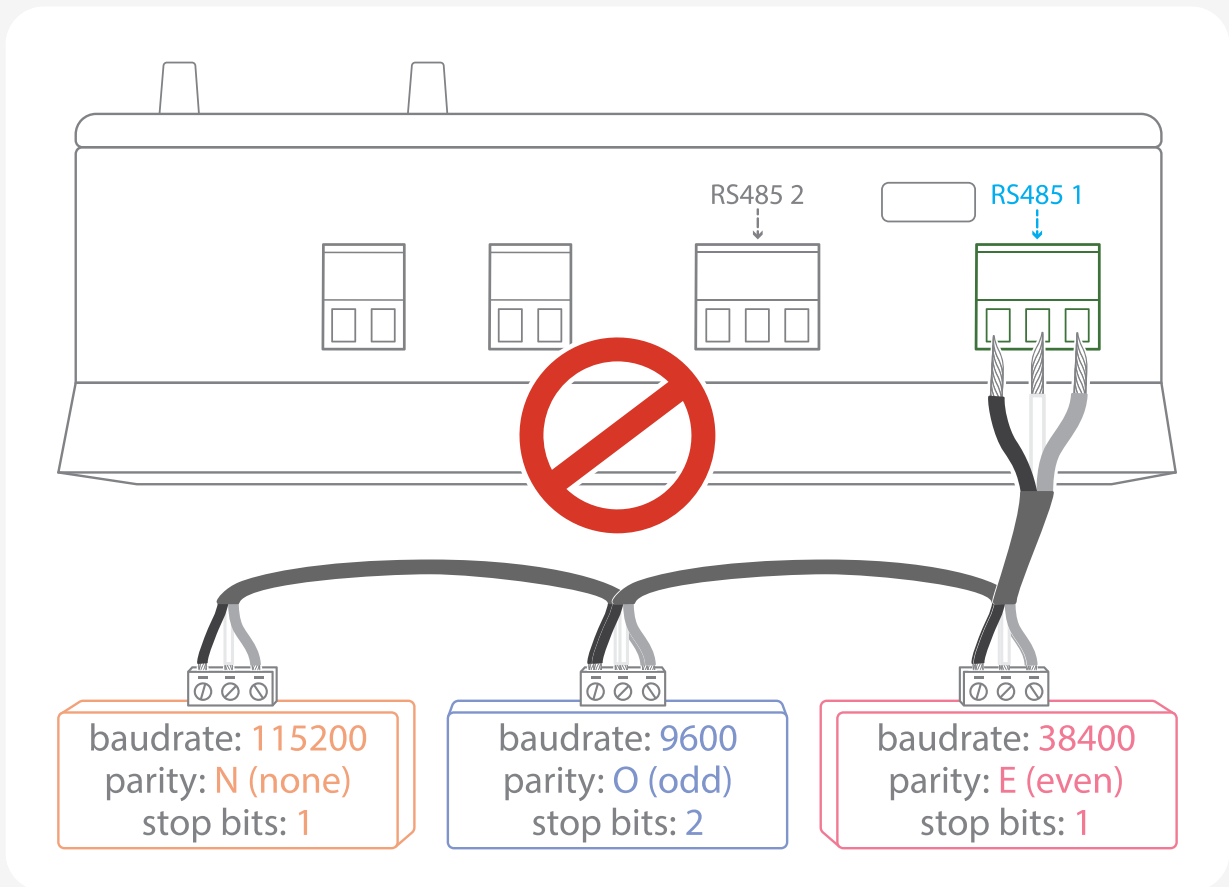
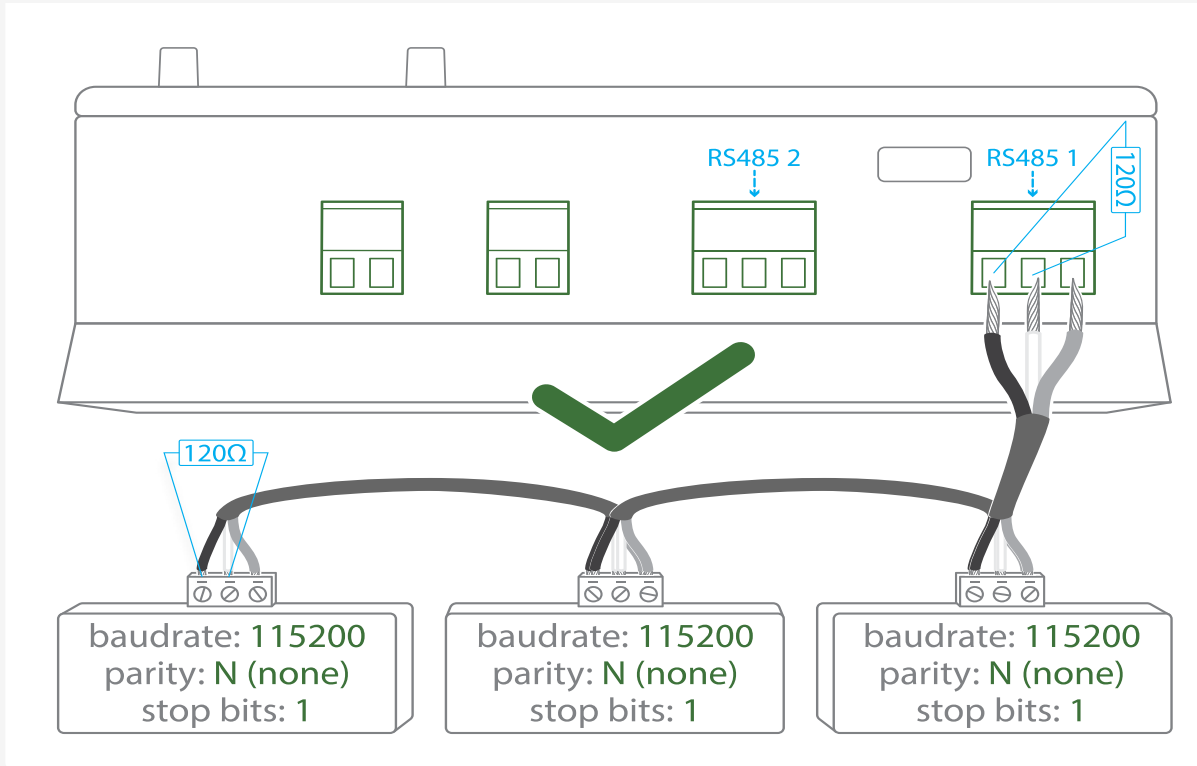

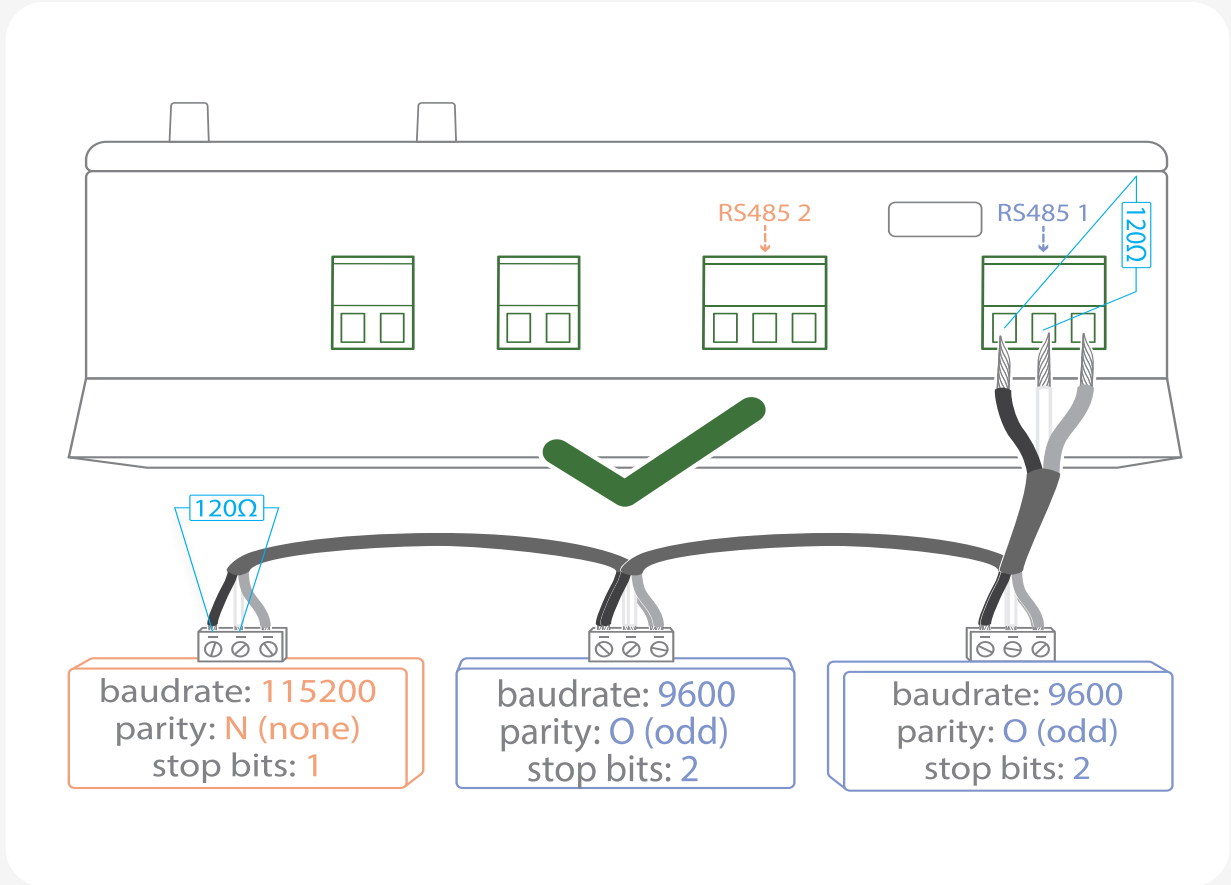

To connect the equipment:

- Caution: Do not group together devices with different communication parameters on the same Bus.

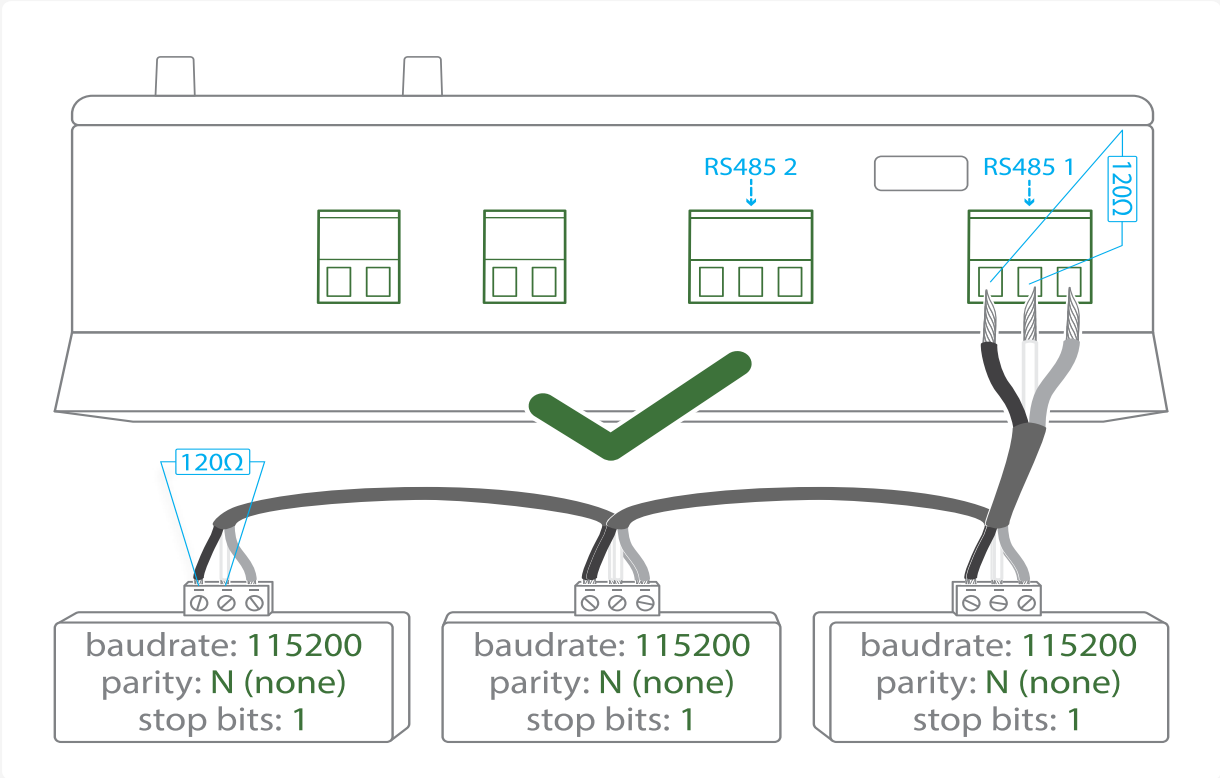

- Serial wire the network or each of the two networks.

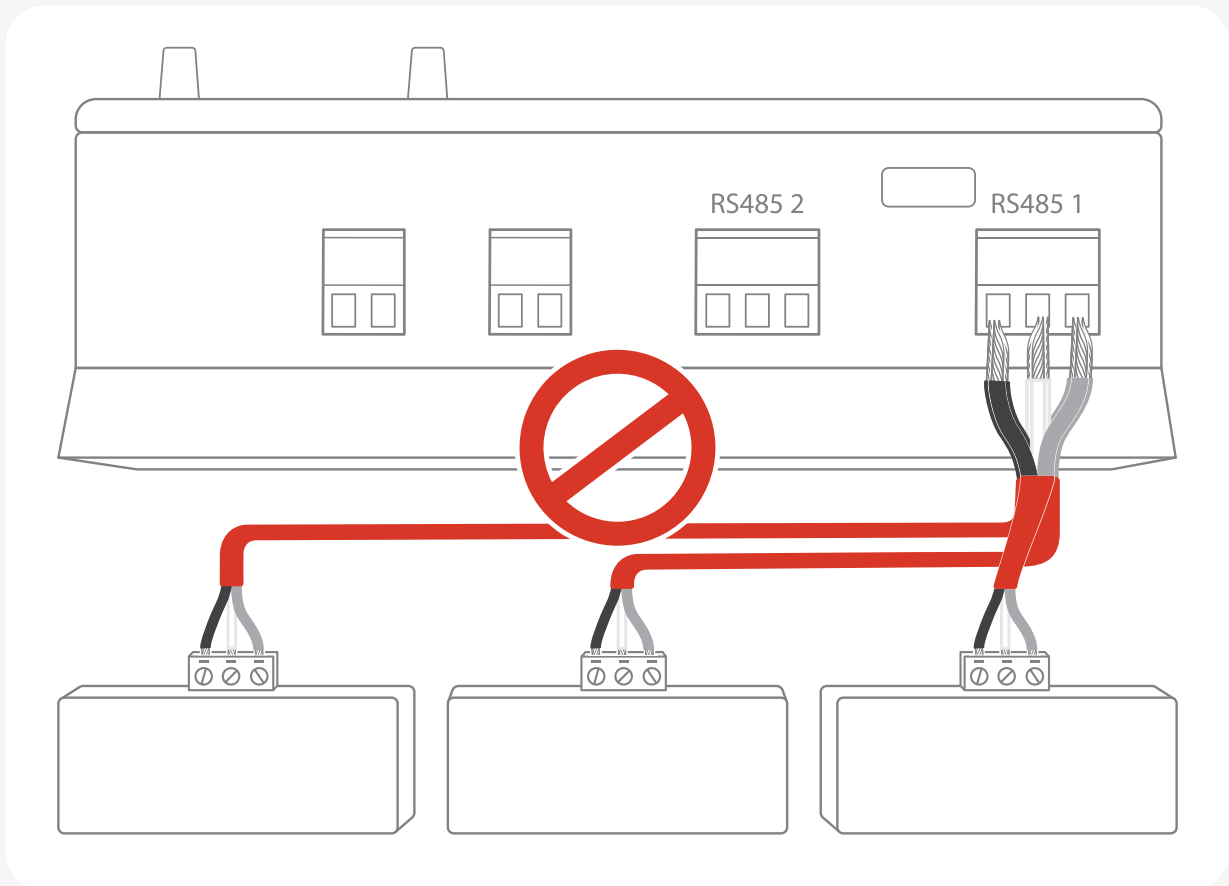
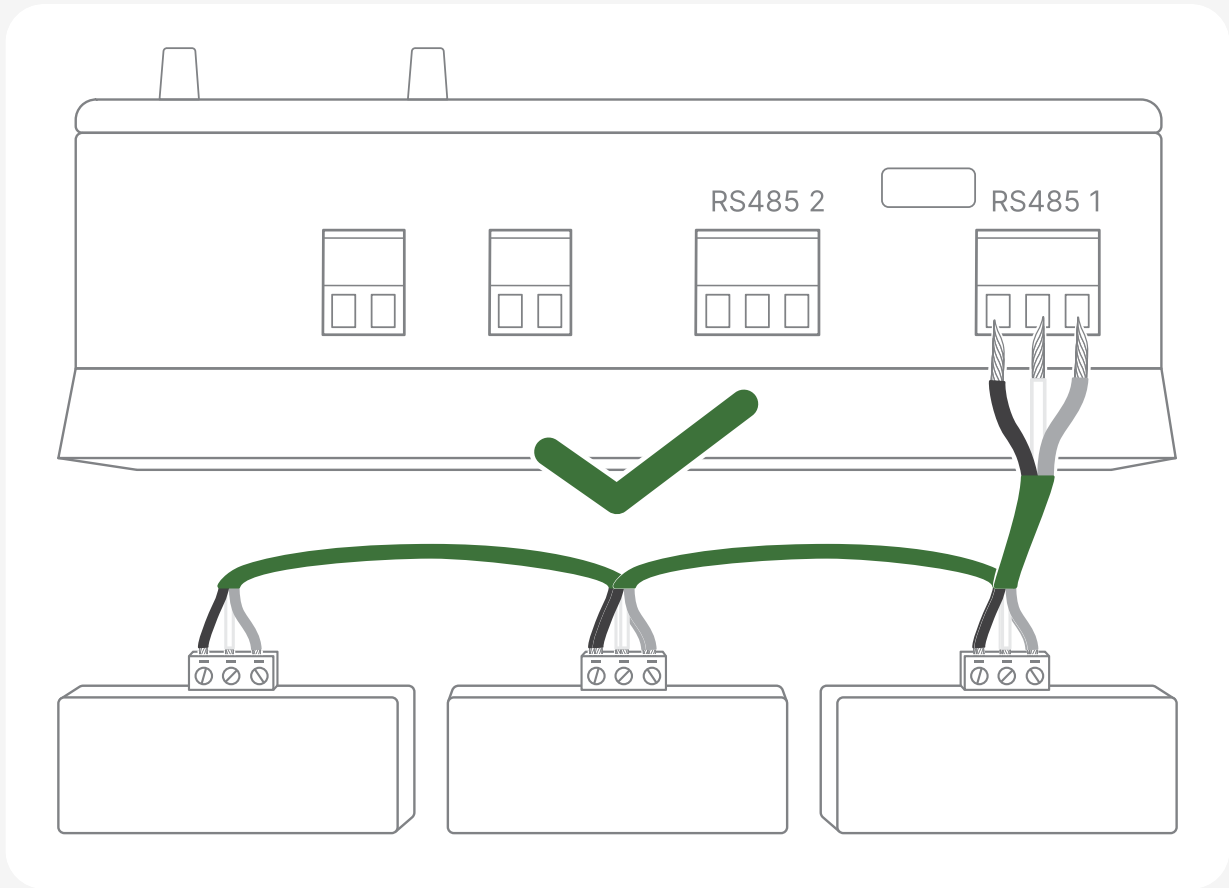

- Connect the network to one of the two RS485 ports of the box

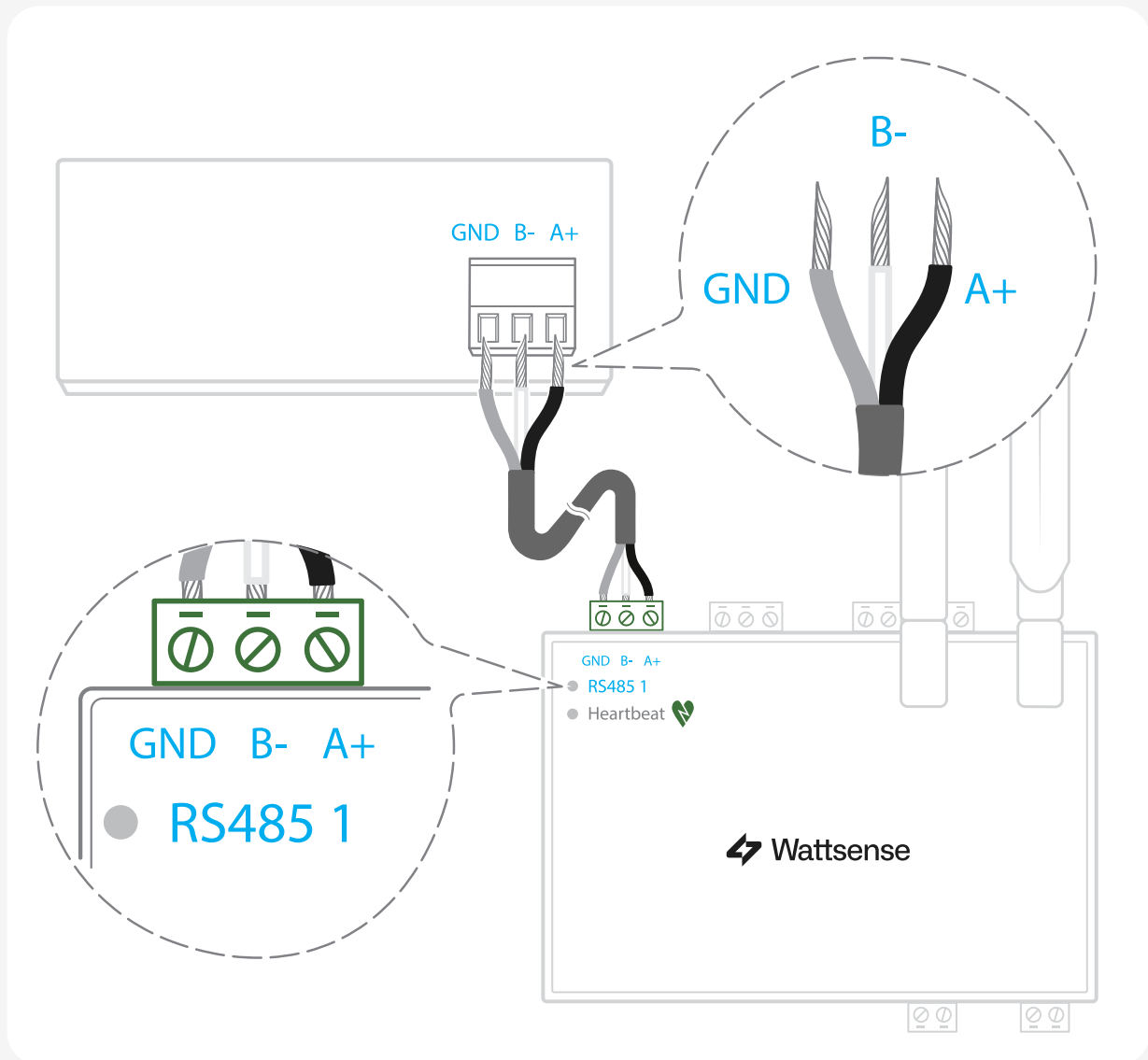

To configure each one of the equipment:

- Configure the address of the 1st Modbus slave to 1, the 2nd to 2, the 3rd to 3 and so on.
- Caution: a network must not contain multiple slaves with the same address.
- Write down the network to which the equipment is connected as well as its address, brand, and model of the equipment and any identifying information. This information will be necessary for the installation configuration and to retrieve data.

● The equipment communicates in BACnet IP

To connect one equipment

- Make sure to have an Ethernet cable.
- Connect the cable to the Ethernet port of the box ETH1 or ETH2.

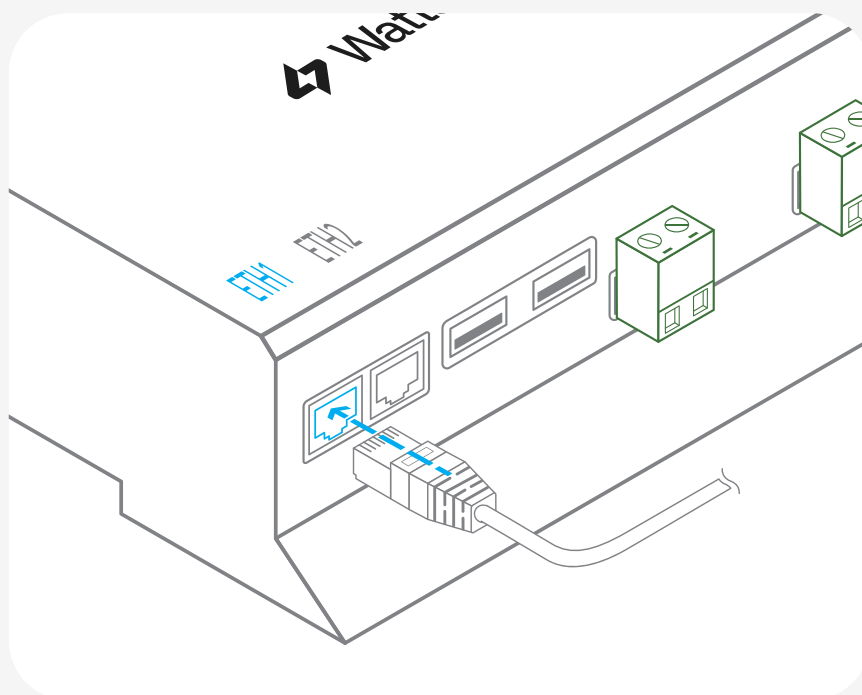

- Connect the other end of the cable to the equipment.

- Verify that the LED ETH1 or ETH2 lights up.

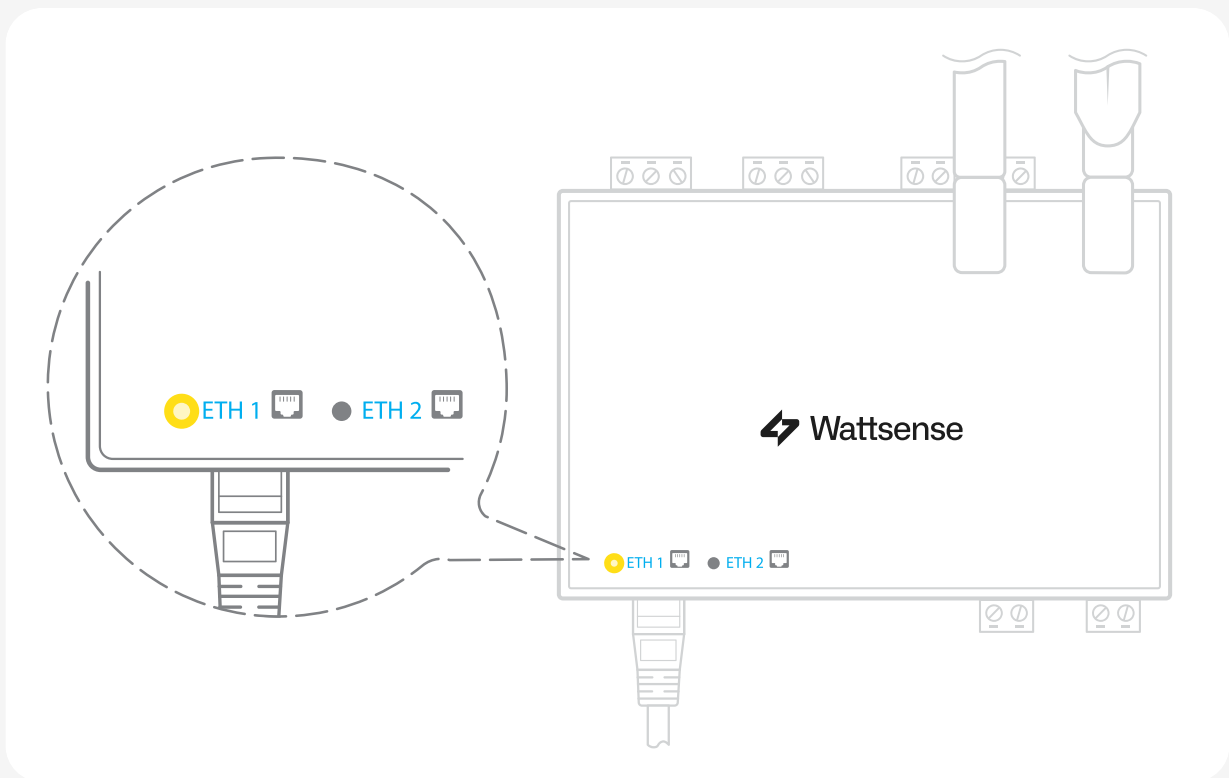

To connect two or more devices

- Make sure to have an Ethernet cable for the box.
- Make sure to have as many Ethernet cables as equipment to connect.
- Make sure to have an Ethernet switch.
- Connect the power supply to the switch.

- Connect an Ethernet cable to the Ethernet port ETH1 or ETH2 of the box.

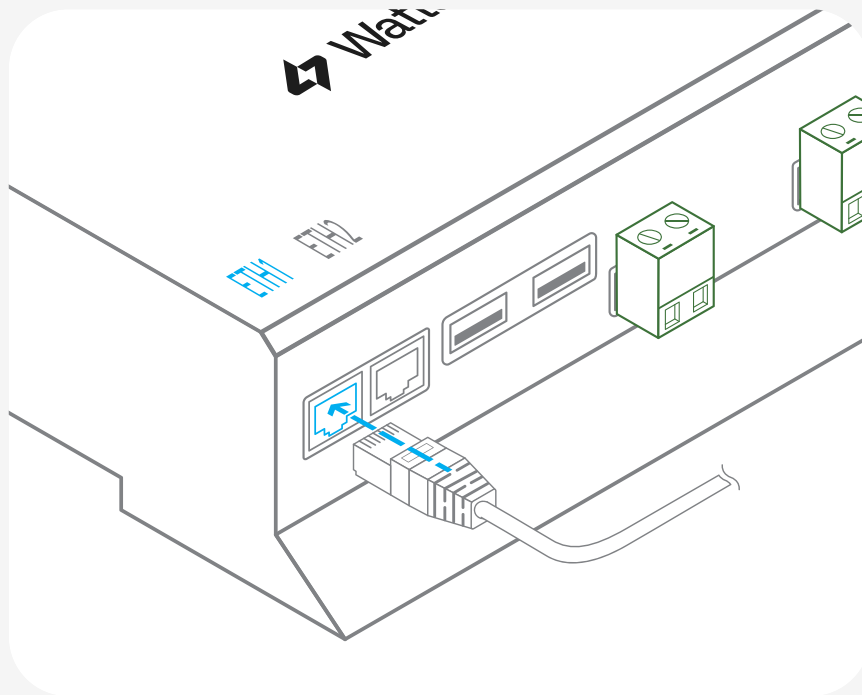

- Connect the other end of this cable to the Ethernet switch.
- Check that the ETH1 or ETH2 LED lights up.

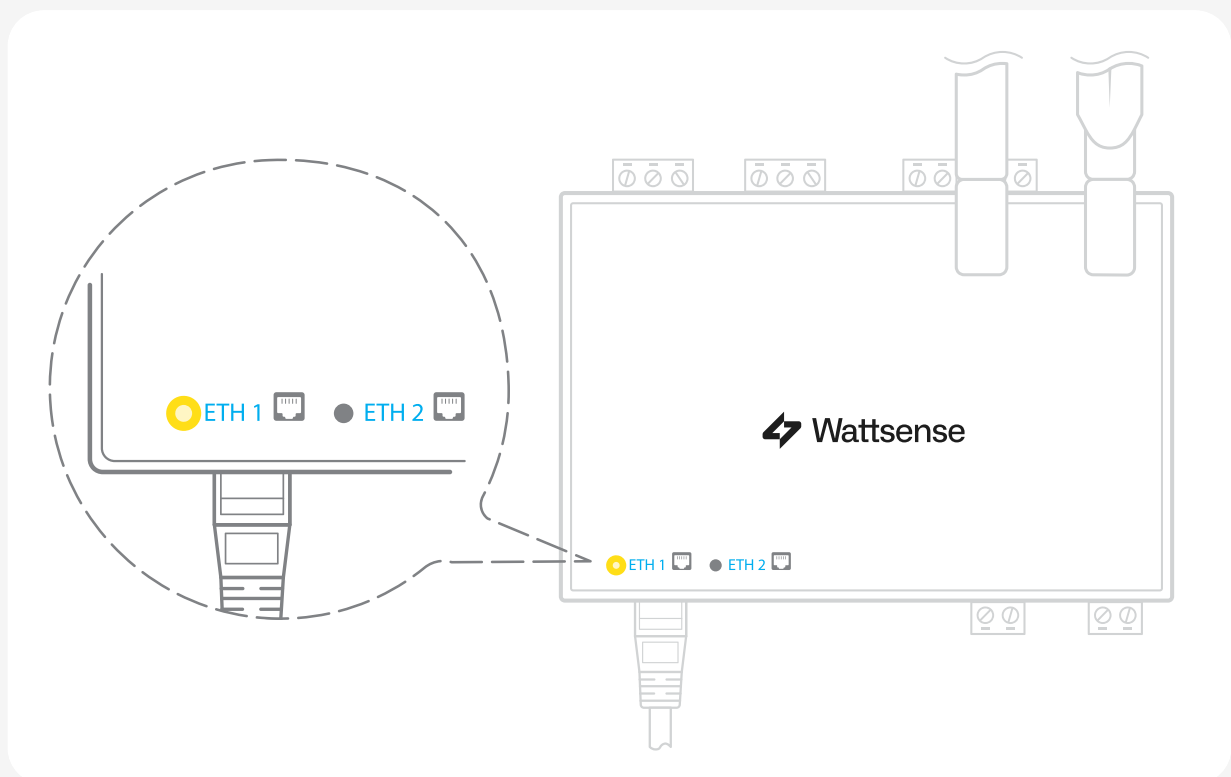

- Connect all equipment to the switch via the Ethernet cables.

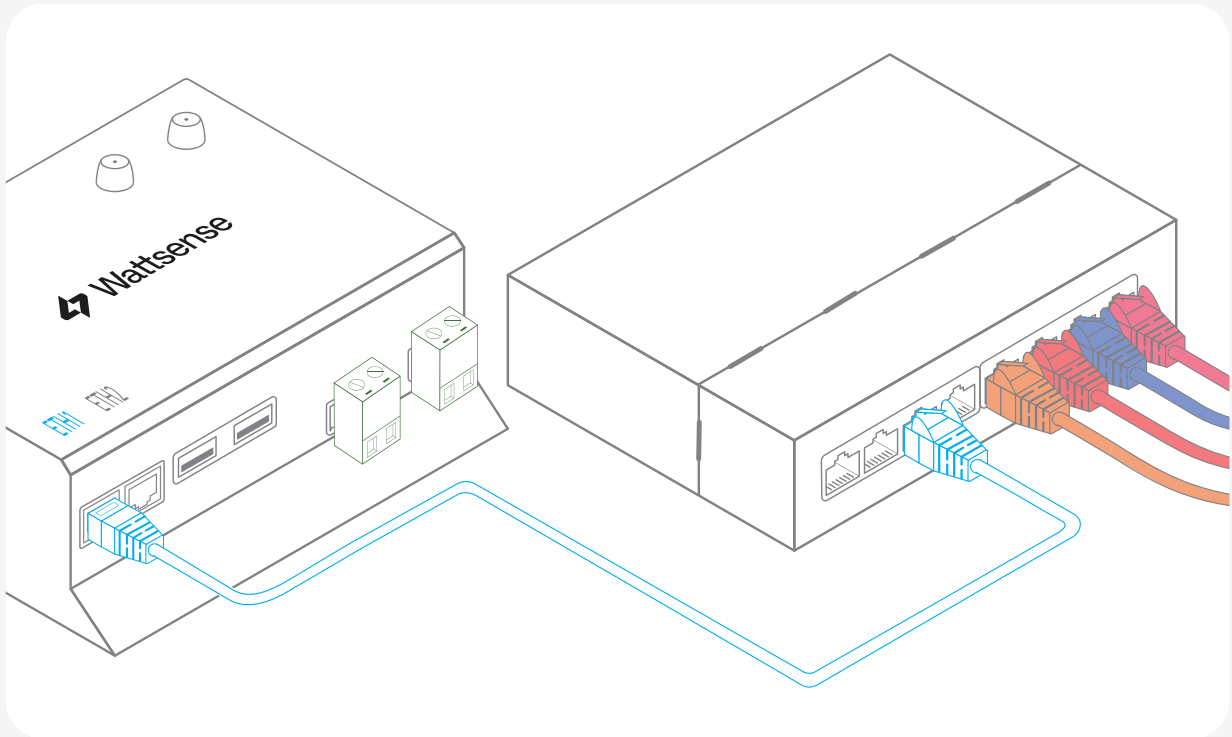

To configure each of the equipment:

- From the technical documentation of the equipment, retrieve its IP address and the BACnet port.
- If the equipment does not have an IP address, assign one to it, 192.168.1.1 for the first device, then 192.168.1.2 for the second device, 192.168.1.3 for the third device, and so on.
- Write down the IP address and BACnet port, the brand, and model of the equipment, and any other identifying information. This information will be required to configure the installation and to retrieve data.

● The equipment communicates in LON IP-852

To connect one or several types of equipment:

- Make sure to have an Ethernet cable.
- Connect the cable to the Ethernet port of the box ETH1 or ETH2.

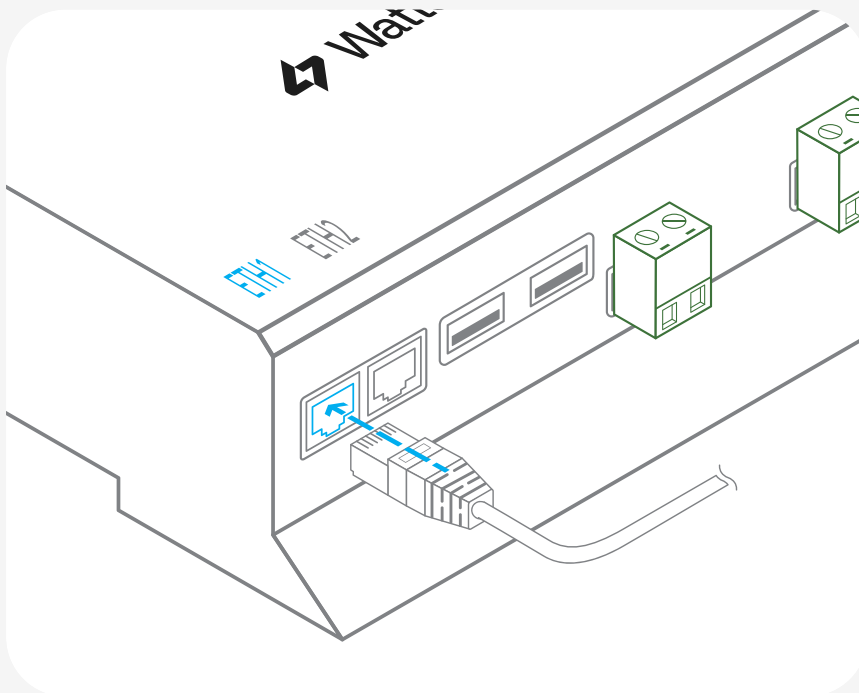

- Connect the other end of the cable to the IP-852 server of the LON network.

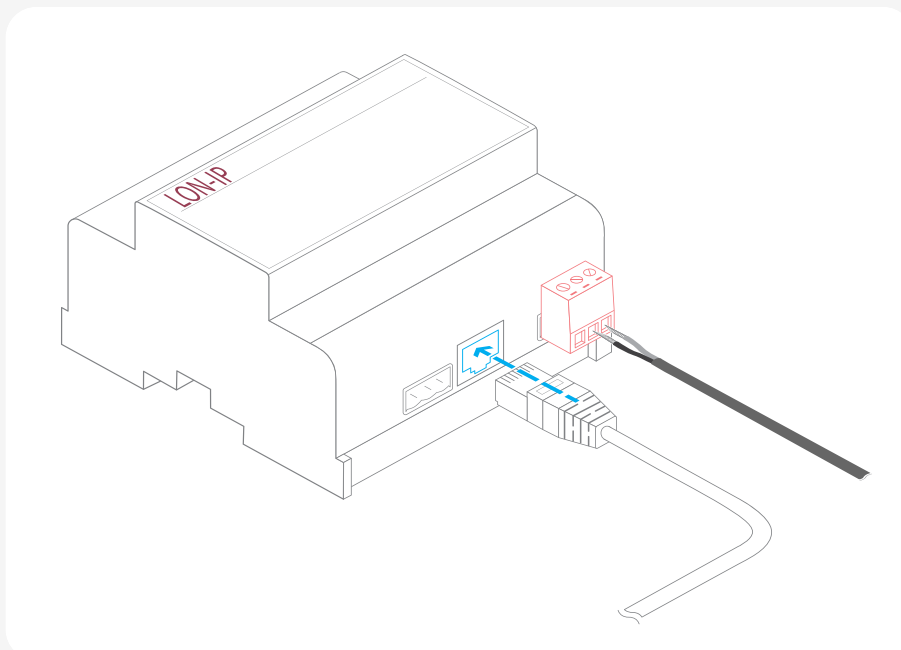

- Verify that the LED ETH1 or ETH2 lights up.

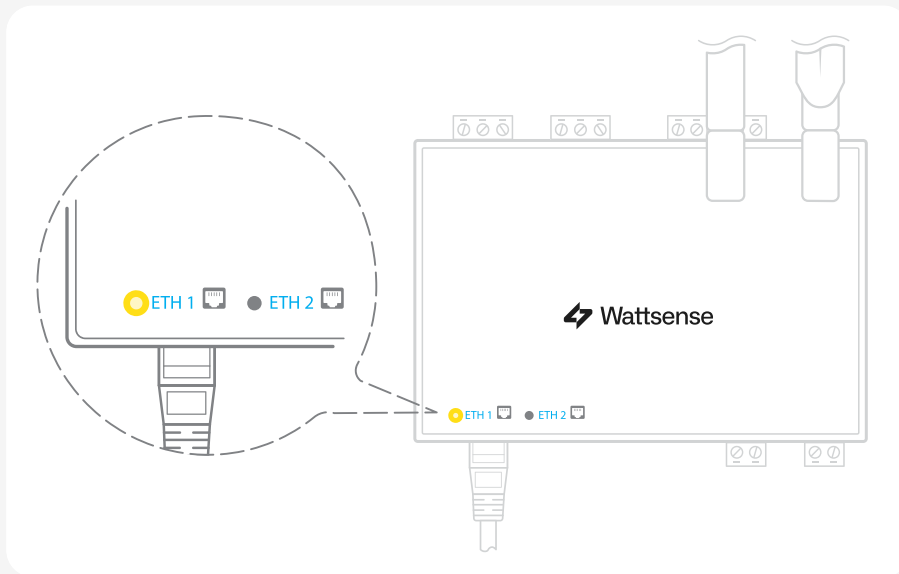

- Register the IP address of the box on the IP-852 server of the LON network.

To configure each of the different equipment:

- Write down the Neuron-ID, brand, model of the equipment, and any identifying information. This information will be necessary for the installation configuration and to retrieve data.
- If you have the NL220 software, export the LON database as an archive file or as a NLC file.

● The equipment communicates in LPB

To connect one or several equipment:

- Connect the LPB Bus to the X-Bus port of the box.
- For each device, connect its MB cable to the X-Bus (-) port and its DB cable to the X-Bus (+) port.

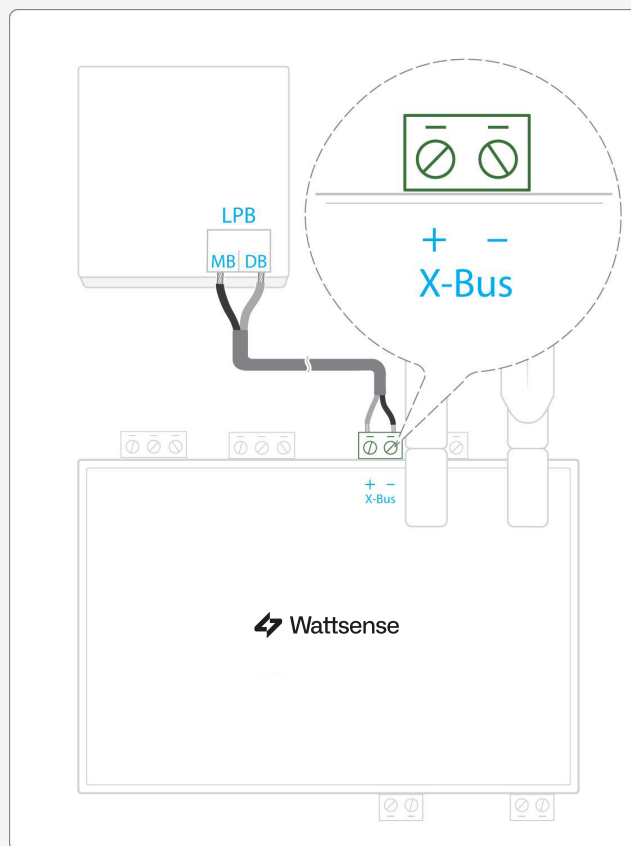

To configure each one of the equipment:

- Be sure that the LPB bus is not powered during your installation to avoid electrical issues. After your installation is completed remember to power it back.
- For each device, configure a unique device number (from 0 to 16).
- Proceed to make the connection as indicated.
- Designate one and only one equipment as the one that supplies the Bus.

● The equipment communicates in KNX

To connect one or several equipment:

- Connect the KNX Bus to the KNX Bus port of the box.
- Each device must connect its (-) signal to the (-) port and its (+) signal to the (+) port.

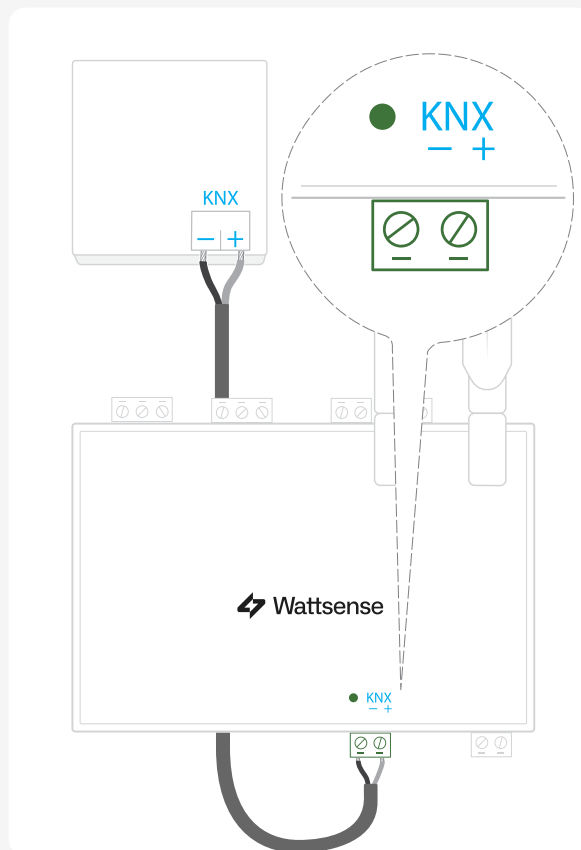

● The equipment communicates in M-BUS

To connect one or several equipments:

The maximum unit load that the device can handle is three devices (3,6mA). If you want to connect more than three M-Bus devices you'll have to use an M-Bus signal repeater.

- Connect the M-Bus device to the M-Bus port.
- Each M-Bus device must connect its (-) signal to the M-Bus (-) port and its (+) signal to the (+) port.

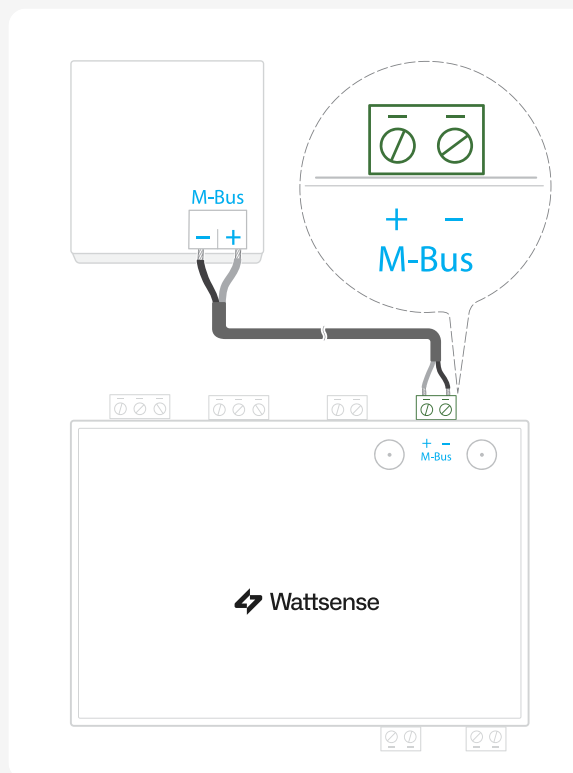

● To connect to LoRaWAN sensors

- Install the box in a central location to ensure the reception of all sensors.
- If the quality of the LoRa signal is good: keep the original antenna installed on the device. You can check the quality of the LoRa signal with:
 - A field tester

The Wattsense User Console. Once the device and the LoRa device are paired you can verify the quality of the signal.

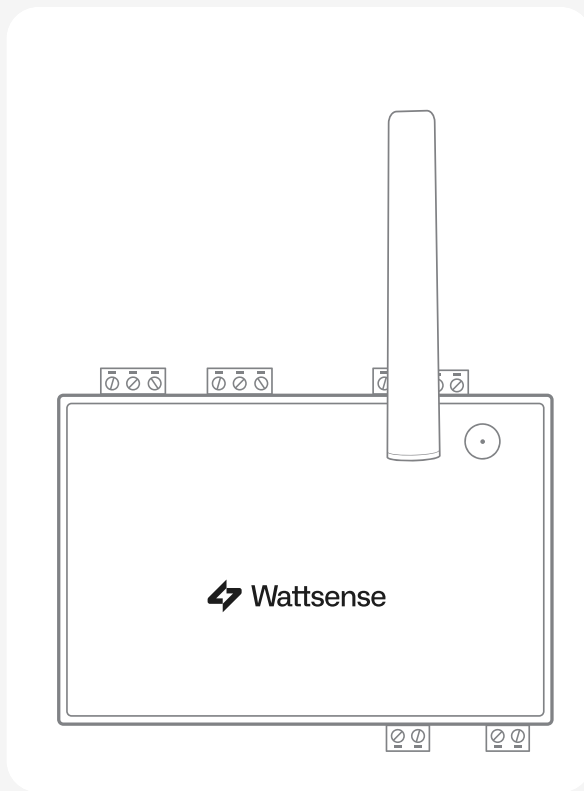

- If the signal quality is insufficient: move the original antenna out of the cabinet; use an RF extension cord with a SMA connector up to 2 meters + 1 adhesive support to hold the antenna.
- If the signal quality is still insufficient: use a High-gain antenna with a maximum of 10 meters of cable; this antenna can for example be used outside or in other floors to obtain the best signal quality

For each sensor, follow these steps:

- 1** Add the sensor to the user console (available at <https://console.wattsense.com>) by naming it to be identifiable.
- 2** Save and send the configuration to the box
- 3** Activate the sensor; to do this, use the manufacturer's technical documentation.
- 4** Check on the user console that the sensor is detected.

Open Source Software

This product, solution or service ("Product") contains third-party software components listed in this document. These components are Open Source Software licensed under a license approved by the Open Source Initiative (www.opensource.org) or similar licenses as determined by Wattsense ("OSS") and/or commercial or freeware software components. With respect to the OSS components, the applicable OSS license conditions prevail over any other terms and conditions covering the Product. The OSS portions of this Product are provided royalty-free and can be used at no charge.

If Wattsense has combined or linked certain components of the Product with/to OSS components licensed under the GNU LGPL version 2 or later as per the definition of the applicable license, and if use of the corresponding object file is not unrestricted ("LGPL Licensed Module", whereas the LGPL Licensed Module and the components that the LGPL Licensed Module is combined with or linked to is the "Combined Product"), the following additional rights apply, if the relevant LGPL license criteria are met:

(i) You are entitled to modify the Combined Product for your own use, including but not limited to the right to modify the Combined Product to relink modified versions of the LGPL Licensed Module, and

(ii) you may reverse-engineer the Combined Product, but only to debug your modifications. The modification right does not include the right to distribute such modifications and you shall maintain in confidence any information resulting from such reverse-engineering of a Combined Product.

Certain OSS licenses require Wattsense to make source code available, for example, the GNU General Public License, the GNU Lesser General Public License and the Mozilla Public License. If such licenses are applicable and this Product is not shipped with the required source code, a copy of this source code can be obtained by anyone in receipt of this information during the period required by the applicable OSS licenses by contacting the following address:

Wattsense - Immeuble Daytona,
4 Chemin du Tronchon
69410 Champagne-au-Mont-d'Or
France

Keyword: Open Source Request Wattsense Box

Wattsense may charge a handling fee of up to 5 EUR to fulfil the request. Warranty regarding further use of the Open Source Software:

Wattsense's warranty obligations are set forth in your agreement with Wattsense. Wattsense does not provide any warranty or technical support for this Product or any OSS components contained in it if they are modified or used in any manner not specified by Wattsense. The license conditions listed below may contain disclaimers that apply between you and the respective licensor. For the avoidance of doubt, Wattsense does not make any warranty commitment on behalf of or binding upon any third-party licensor.

All open-source software components used within the product copyright holders and the license conditions are contained on the website at: https://docs.wattsense.com/refs/LicenseInfo-WattSense%20Box-V6.1.7-2024-03_25.txt.

Support

The website support.wattsense.com/portal contains useful information about Wattsense's product (Tutorials, Knowledge base, etc..)

To alert the support team about any issues you are experiencing, please send an email to support@wattsense.com or create a ticket in our support platform.

Please click here: <https://support.wattsense.com/portal/en/newticket>

The support team will get back to you as soon as possible.

