



LoRaWAN Liquid Level Sensor User Manual

Document Version: 1.2.1

Image Version: v1.0

Version	Description	Date
1.0	Release	2020-Aug-08
1.1	Add different hardware UART Connection photo	2020-Nov-5
1.1.1	Typo for Payload format	2021-Mar-1
1.2.0	Update Example to TTN v3	2021-May-10
1.2.1	Add DS18B20 probe option	2022-Feb-4

1.	Introduction	3
1.1	What is LoRaWAN Ultrasonic liquid level sensor	3
1.2	Features	4
1.3	Suitable Container & Liquid	4
1.4	Mechanical	4
1.5	Install LDDS20	5
1.6	Applications	6
1.7	Precautions	6
1.8	Pin mapping and power on	7
2.	Configure LDDS20 to connect to LoRaWAN network	8
2.1	How it works	8
2.2	Quick guide to connect to LoRaWAN server (OTAA)	8
2.3	Uplink Payload	14
2.3.1	Battery Info	14
2.3.2	Liquid height	14
2.3.3	Digital Interrupt	14
2.3.4	DS18B20 Temperature sensor	15
2.3.5	Sensor Flag	15
2.3.6	Decode payload in The Things Network	15
2.4	Downlink Payload	15
2.5	Show Data in Datacake IoT Server	17
2.6	LED Indicator	20
2.7	Firmware Change Log	21
2.8	Battery Analysis	21
2.8.1	Battery Type	21
2.8.2	Battery Note	21
2.8.3	Replace the battery	21
2.8.4	Battery Life Analyze	22
3.	Using the AT Commands	23
3.1	Access AT Commands	23
3.2	Set Interrupt Mode	25
4.	FAQ	27
4.1	What is the frequency plan for LDDS20?	27
4.2	How to change the LoRa Frequency Bands/Region?	27
5.	Trouble Shooting	27
5.1	Why I can't join TTN V3 in US915 / AU915 bands?	27
5.2	AT Command input doesn't work	27
6.	Order Info	28
7.	Packing Info	28
8.	Support	28

1. Introduction

1.1 What is LoRaWAN Ultrasonic liquid level sensor

The Dragino LDDS20 is a **LoRaWAN Ultrasonic liquid level sensor** for Internet of Things solution. It uses **none-contact method** to measure the height of liquid in a container without opening the container, and send the value via LoRaWAN network to IoT Server

The LDDS20 sensor is installed directly below the container to detect the height of the liquid level. User doesn't need to open a hole on the container to be tested. The **none-contact measurement makes the measurement safety, easier and possible for some strict situation.**

LDDS20 uses ultrasonic sensing technology for distance measurement. LDDS20 is of high accuracy to measure various liquid such as: **toxic substances, strong acids, strong alkalis** and **various pure liquids** in high-temperature and high-pressure airtight containers.

The LoRa wireless technology used in LDDS20 allows device to send data and reach extremely long ranges at low data-rates. It provides ultra-long range spread spectrum communication and high interference immunity whilst minimizing current consumption.

LDDS20 is powered by **8500mA Li-SOCI2 battery**; It is designed for long term use up to 10 years*.

Each LDDS20 pre-loads with a set of unique keys for LoRaWAN registrations, register these keys to local LoRaWAN server and it will auto connect if there is network coverage, after power on.

*Actually lifetime depends on network coverage and uplink interval and other factors

LDDS20 in a LoRaWAN Network



1.2 Features

- ◇ LoRaWAN 1.0.3 Class A
- ◇ Ultra low power consumption
- ◇ Liquid Level Measurement by Ultrasonic technology
- ◇ Measure through container, No need to contact Liquid.
- ◇ Valid level range 20mm - 2000mm
- ◇ Accuracy: $\pm(5\text{mm}+S*0.5\%)$ (S: Measure Value)
- ◇ Cable Length : 25cm
- ◇ Bands: CN470/EU433/KR920/US915/EU868/AS923/AU915/IN865
- ◇ AT Commands to change parameters
- ◇ Uplink on periodically
- ◇ Downlink to change configure
- ◇ IP66 Waterproof Enclosure
- ◇ 8500mAh Battery for long term use

1.3 Suitable Container & Liquid

- ◇ Solid Wall container such as: steel, iron, glass, ceramics, non-foaming plastics etc.
- ◇ Container shape is regular, and surface is smooth.
- ◇ Container Thickness:
 - ✓ Pure metal material. 2~8mm, best is 3~5mm
 - ✓ Pure non metal material: <10 mm
- ◇ Pure liquid without irregular deposition.

1.4 Mechanical

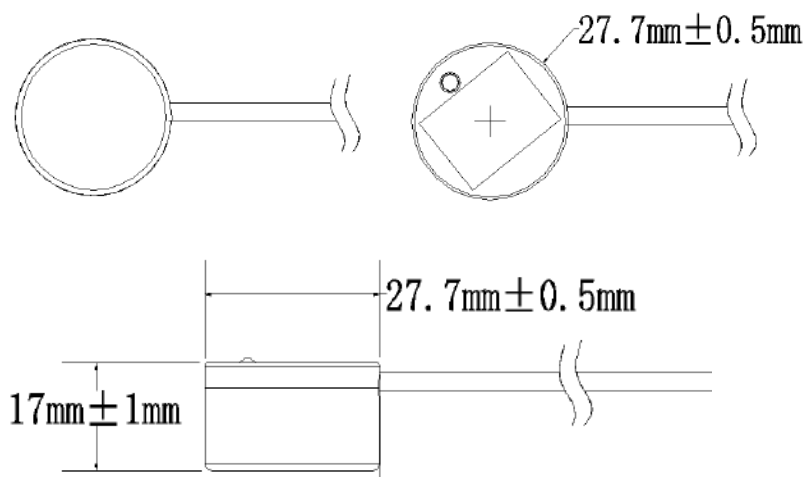

1.5 Install LDDS20

Step 1: Choose the installation point.

LDDS20 **MUST** be installed on the container bottom middle position.

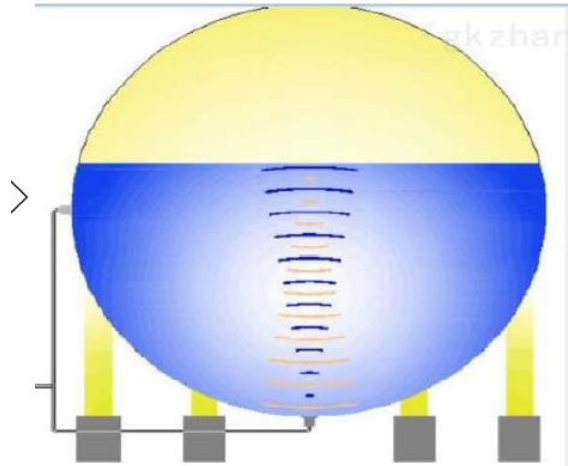

Step 2: Polish the installation point.

For Metal Surface with paint, it is important to polish the surface, first use crude sand paper to polish the paint level, then use exquisite sand paper to polish the metal level to make it shine & smooth. .

No polish needed if the container is shine metal surface without paint or non-metal container.



Step3: Test the installation point.

Power on LDDS75, check if the blue LED is on, If the blue LED is on, means the sensor works. Then put ultrasonic coupling paste on the sensor and put it tightly on the installation point.

It is necessary to put the coupling paste between the sensor and the container, otherwise LDDS20 won't detect the liquid level.

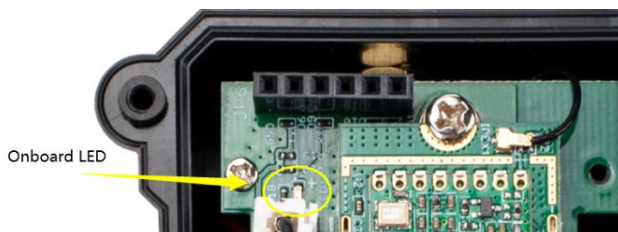

After paste the LDDS20 well, power on LDDS20. In the first 30 seconds of booting, device will check the sensors status and BLUE LED will show the status as below. After 30 seconds, BLUE LED will be off to save battery life.

LED Status:

- **Onboard LED:** When power on device, the onboard LED will fast blink 4 times which means detect the sensor well.
- **BLUE LED always ON:** Sensor is power on but doesn't detect liquid. There is problem in installation point.
- **BLUE LED slowly blinking:** Sensor detects Liquid Level, The installation point is good. LDDS20 will enter into low power mode at 30 seconds after system reset or power on, Blue LED will be off after that.

Note 2:

Ultrasonic coupling paste is subjected in most shipping way. So the default package doesn't include it and user needs to purchase locally.

Step4: Install use Epoxy ab glue.

Prepare Epoxy AB glue.

Put Epoxy AB glue in the sensor and press it hard on the container installation point.

Reset LDDS20 and see if the BLUE LED is slowly blinking.



Note1:

Epoxy AB glue needs 3~ 5 minutes to stable attached. we can use other glue material to keep it in the position.

Note 2:

Epoxy AB glue is subjected in most shipping way. So the default package doesn't include it and user needs to purchase locally.

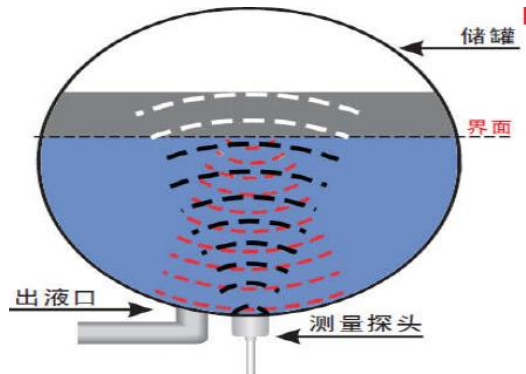

1.6 Applications

- ✧ Smart liquid control solution.
- ✧ Smart liquefied gas solution.

1.7 Precautions

- ✧ At room temperature, containers of different materials, such as steel, glass, iron, ceramics, non-foamed plastics and other dense materials, have different detection blind areas and detection limit heights.
- ✧ For containers of the same material at room temperature, the detection blind zone and detection limit height are also different for the thickness of the container.

- ✧ When the detected liquid level exceeds the effective detection value of the sensor, and the liquid level of the liquid to be measured shakes or tilts, the detected liquid height is unstable.

1.8 Pin mapping and power on

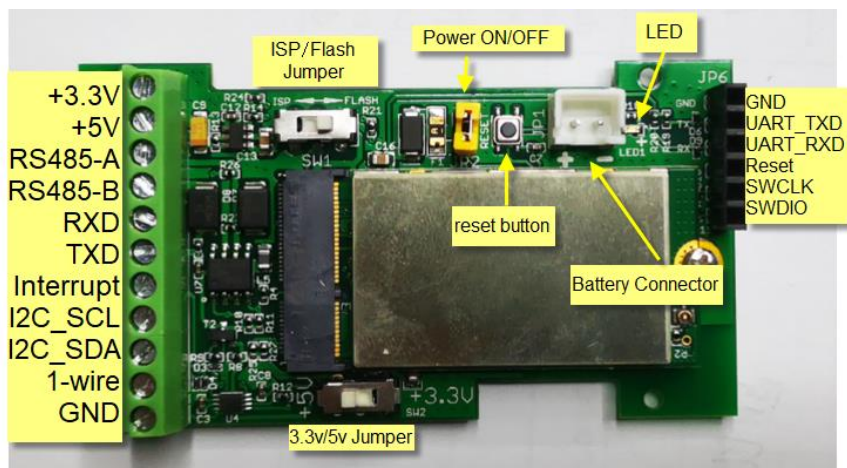

2. Configure LDDS20 to connect to LoRaWAN network

2.1 How it works

The LDDS20 is configured as LoRaWAN OTAA Class A mode by default. It has OTAA keys to join LoRaWAN network. To connect a LoRaWAN network, you need to input the OTAA keys in the LoRaWAN IoT server and power on the LDDS20. If there is coverage of the LoRaWAN network, it will automatically join the network via OTAA and start to send the sensor value

In case you can't set the OTAA keys in the LoRaWAN OTAA server, and you have to use the keys from the server, you can [use AT Commands](#) to set the keys in the LDDS20.

2.2 Quick guide to connect to LoRaWAN server (OTAA)

Following is an example for how to join the [TTN V3 LoRaWAN Network](#). Below is the network structure; we use the [LG308](#) as a LoRaWAN gateway in this example.

LDDS20 in a LoRaWAN Network



The LG308 is already set to connected to [TTN V3 network](#), so what we need to now is configure the TTN V3 server.

Step 1: Create a device in TTN V3 with the OTAA keys from LDDS20.

Each LDDS20 is shipped with a sticker with the default device keys, user can find this sticker in the box. it looks like below.



For OTAA registration, we need to set **APP EUI/ APP KEY/ DEV EUI**. Some server might no need to set APP EUI.

Enter these keys in the LoRaWAN Server portal. Below is TTN V3 screen shot:

Add APP EUI in the application

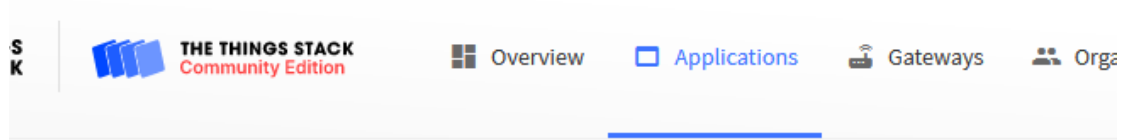

Add application

Owner*

Application ID*

Application name

Description

Optional application description; can also be used to save notes about the application

Create application

CCC
ID: 123

4 End devices 2 Collaborators 2 API keys Created 95 days ago

General information

Application ID	123
Created at	Feb 2, 2021 11:12:30
Last updated at	Apr 30, 2021 11:00:33

Live data See all activity →

- ↑ 10:09:42 1231234234... Forward data message to Application Server
- ⓘ 10:09:42 1231234234... Store upstream data message
- ↑ 10:09:42 1231234234... Forward uplink data message
- ↑ 10:09:42 1231234234... Receive uplink data message
- ↑ 10:09:42 1231234234... Successfully processed data message
- ↑ 10:09:42 1231234234... Drop data message

End devices (4)

Search by ID Import end devices **+ Add end device**

ID	Name	DevEUI	JoinEUI	Created
----	------	--------	---------	---------

Register end device

[From The LoRaWAN Device Repository](#) Manually

1. Select the end device

Brand*

Model*

Cannot find your exact end device? [Device registration.](#)

- LBT1
- LDL20
- LDL75
- LDS01
- LGT92
- LHT65
- LSE01
- LSN50-V2

2. Enter registration data

Please choose an end device first to

2. Enter registration data

Frequency plan*

The frequency plan used by the end device

AppEUI*

The AppEUI uniquely identifies the owner of the end device. If no AppEUI is provided by the device manufacturer (usually for development), it can be filled with zeros.

You can also choose to create the device manually.

Register end device

From The LoRaWAN Device Repository

Manually

Preparation

Activation mode *

- Over the air activation (OTAA)
- Activation by personalization (ABP)
- Multicast
- Do not configure activation

LoRaWAN version ? *

Network Server address

Application Server address

External Join Server ?

Add APP KEY and DEV EUI

2. Enter registration data

Frequency plan ⓘ *

Europe 863-870 MHz (SF12 for RX2)

The frequency plan used by the end device

AppEUI ⓘ *

..... 00

The AppEUI uniquely identifies the owner of the end device. If no AppEUI is provided by the device manufacturer (usually for dev

DevEUI ⓘ *

.....

The DevEUI is the unique identifier for this end device

AppKey ⓘ *

.....

The root key to derive session keys to secure communication between the end device and the application

End device ID *

my-new-device

After registration

Step 2: Power on LDDS20

Put a Jumper on JP2 to power on the device. (The switch must be set in FLASH position).



Step 3: The LDDS20 will auto join to the TTN V3 network. After join success, it will start to upload messages to TTN V3 and you can see the messages in the panel.

↑ 10:35:00	Forward data message to Applic...	DevAddr: 26 08 52 6E	MAC payload: 17 BF BD 86 C1	FPort: 2	SNR: 9.5	RSSI: -53	Bandwidth: 125000		
↑ 10:35:00	Forward uplink data message	DevAddr: 26 08 52 6E	Payload: { bat: 3.35, distance: 2671 }	80 16 8A 6F 00	FPort: 2	SNR: 9.5	RSSI: -53	Bandwidth: 125000	
↑ 10:35:00	Receive uplink data message	DevAddr: 26 08 52 6E							
↑ 10:35:00	Successfully processed data me...	DevAddr: 26 08 52 6E	FCnt: 14770	FPort: 2	MAC payload: 17 BF BD 86 C1	Bandwidth: 125000	SNR: 9.5	RSSI: -53	Raw payload: 40 6
↑ 10:35:00	Drop data message	Uplink is a duplicate							
↑ 10:35:00	Receive data message	DevAddr: 26 08 52 6E	FCnt: 14770	FPort: 2	MAC payload: 17 BF BD 86 C1	Bandwidth: 125000	SNR: 9.5	RSSI: -58	Raw payload: 40 6
↑ 10:35:00	Receive data message	DevAddr: 26 08 52 6E	FCnt: 14770	FPort: 2	MAC payload: 17 BF BD 86 C1	Bandwidth: 125000	SNR: 9.5	RSSI: -53	Raw payload: 40 6

2.3 Uplink Payload

LDDS20 will uplink payload via LoRaWAN with below payload format:

Uplink payload includes in total 8 bytes.

Payload for firmware version v1.1.4. . Before v1.1.3, there is only 5 bytes: BAT and Distance(Please check manual v1.2.0 if you have 5 bytes payload).

Size(bytes)	2	2	1	2	1
Value	BAT	Distance (unit: mm)	Digital Interrupt (Optional)	Temperature (Optional)	Sensor Flag

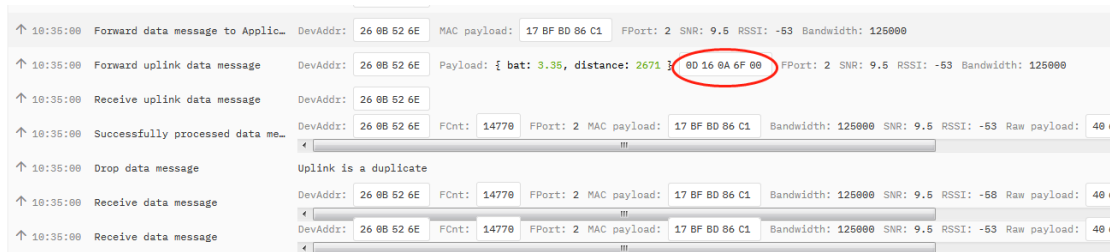

2.3.1 Battery Info

Check the battery voltage for LDDS20.

Ex1: 0x0B45 = 2885mV

Ex2: 0x0B49 = 2889mV

2.3.2 Liquid height

Get the distance. Flat object range 20mm - 2000mm.

For example, if the data you get from the register is 0x06 0x05, the distance between the sensor and the measured object is

$$0605(H) = 1541 (D) = 1541 \text{ mm.}$$

If the sensor value is 0x0000, it means system doesn't detect ultrasonic sensor.

If the sensor value lower than 0x0014 (20mm), the sensor value will be invalid.

2.3.3 Digital Interrupt

This data field shows if this packet is generated by interrupt or not. [Click here](#) for the hardware and software set up.

Example:

0x00: Normal uplink packet.

0x01: Interrupt Uplink Packet.

2.3.4 DS18B20 Temperature sensor

This is optional, user can connect external DS18B20 sensor to the [+3.3v, 1-wire and GND pin](#) and this field will report temperature.

Example:

If payload is: 0105H: (0105 & FC00 == 0), temp = 0105H /10 = 26.1 degree

If payload is: FF3FH : (FF3F & FC00 == 1) , temp = (FF3FH - 65536)/10 = -19.3 degrees.

Note: DS18B20 feature is supported in the hardware version > v1.3 which made since early of 2021.

2.3.5 Sensor Flag

0x01: Detect Ultrasonic Sensor

0x00: No Ultrasonic Sensor

2.3.6 Decode payload in The Things Network

While using TTN V3 network, you can add the payload format to decode the payload.

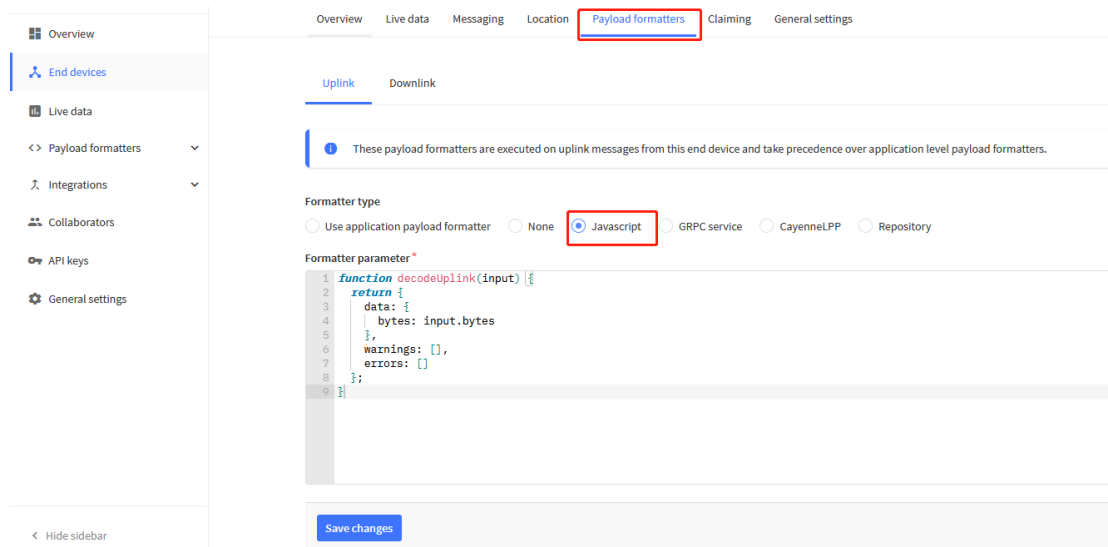

The payload decoder function for TTN V3 is here:

LDDS20 TTN V3 Payload Decoder:

http://www.dragino.com/downloads/index.php?dir=LoRa_End_Node/LDDS20/Payload_Decoder/

2.4 Downlink Payload

By default, LDDS20 prints the downlink payload to console port.

Downlink Control Type	FPort	Type Code	Downlink payload size(bytes)
-----------------------	-------	-----------	------------------------------

TDC (Transmit Time Interval)	Any	01	4
RESET	Any	04	2
AT+CFM	Any	05	4
INTMOD	Any	06	4

Examples

Set TDC

If the payload=0100003C, it means set the END Node's TDC to 0x00003C=60(S), while type code is 01.

Payload: 01 00 00 1E TDC=30S

Payload: 01 00 00 3C TDC=60S

Reset

If payload = 0x04FF, it will reset the LDDS20

CFM

Downlink Payload: 05000001, Set AT+CFM=1 or 05000000 , set AT+CFM=0

2.5 Show Data in Datacake IoT Server

Datacake provides a human friendly interface to show the sensor data, once we have data in TTN V3, we can use Datacake to connect to TTN V3 and see the data in Datacake. Below are the steps:

Step 1: Be sure that your device is programmed and properly connected to the network at this time.

Step 2: To configure the Application to forward data to Datacake you will need to add integration. To add the Datacake integration, perform the following steps:

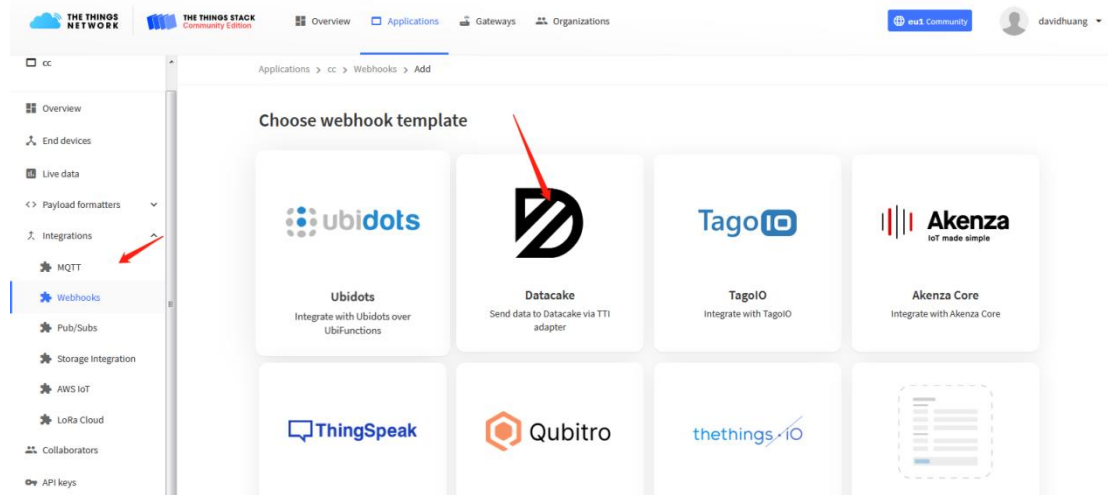

Add custom webhook

Template information



Datacake

Send data to Datacake via TTI adapter

[About Datacake](#) | [Documentation](#)

Template settings

Webhook ID*

Token*

Datacake API Token

Create datacake webhook

Step 3: Create an account or log in Datacake.

Step 4: Search the LDDS75 and add DevEUI. (Note: LDDS20 use same payload as LDDS75)

Complex configuration and setup.

All Manufacturers
⌵

Dragino LSE01
Dragino

Dragino LT-22222-L
Dragino

Dragino LWL01
Dragino

ESP32-Paxcounter
cyberman54

Elsys ELT-2
Elsys.se

Showing 26 to 30 of 79 results

Previous
Next

Next

After added, the sensor data arrive TTN V3, it will also arrive and show in Datacake.

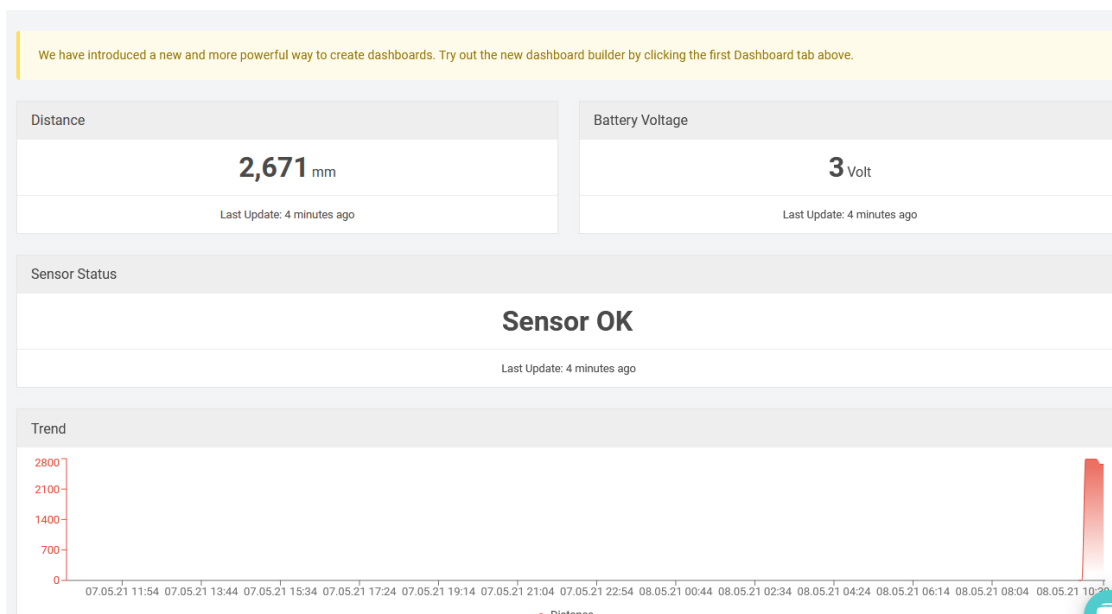

2.6 LED Indicator

The LDDS20 has an internal LED which is to show the status of different state.

- Blink once when device power on.
- The device detects the sensor and flashes 5 times.
- Solid ON for 5 seconds once device successful Join the network.
- Blink once when device transmit a packet.

2.7 Firmware Change Log

Firmware download link:

http://www.dragino.com/downloads/index.php?dir=LoRa_End_Node/LSE01/Firmware/

Firmware Upgrade Method:

http://wiki.dragino.com/index.php?title=Firmware_Upgrade_Instruction_for_STM32_base_products#Introduction

2.8 Battery Analysis

2.8.1 Battery Type

The LDDS20 battery is a combination of a 8500mAh Li/SOCI2 Battery and a Super Capacitor. The battery is non-rechargeable battery type with a low discharge rate (<2% per year). This type of battery is commonly used in IoT devices such as water meter.

The battery is designed to last for more than 10 years for the LDDS20.

The battery related documents as below:

- [Battery Dimension](#),
- [Lithium-Thionyl Chloride Battery datasheet](#)
- [Lithium-ion Battery-Capacitor datasheet](#),



2.8.2 Battery Note

The Li-SICO battery is designed for small current / long period application. It is not good to use a high current, short period transmit method. The recommended minimum period for use of this battery is 5 minutes. If you use a shorter period time to uplink data, then the battery life may be decreased.

2.8.3 Replace the battery

You can change the battery in the NBSN95. The type of battery is not limited as long as the output is between 3v to 3.6v. On the main board, there is a diode (D1) between the battery and the main circuit. If you need to use a battery with less than 3.3v, please remove the D1

and shortcut the two pads of it so there won't be voltage drop between battery and main board.

The default battery pack of NBSN95 includes a ER26500 plus super capacitor. If user can't find this pack locally, they can find ER26500 or equivalence without the SPC1520 capacitor, which will also work in most case. The SPC can enlarge the battery life for high frequency use (update period below 5 minutes)

2.8.4 Battery Life Analyze

Dragino battery powered products are all run in Low Power mode. User can check the guideline from this link to calculate the estimate battery life:

https://www.dragino.com/downloads/downloads/LoRa_End_Node/Battery_Analyze/DRAGINO_Battery_Life_Guide.pdf

3. Using the AT Commands

3.1 Access AT Commands

LDDS20 supports AT Command set in the stock firmware. You can use a USB to TTL adapter to connect to LDDS20 for using AT command, as below.



Or if you have below board, use below connection:



In the PC, you need to set the serial baud rate to **9600** to access the serial console for LDDS20. LDDS20 will output system info once power on as below:

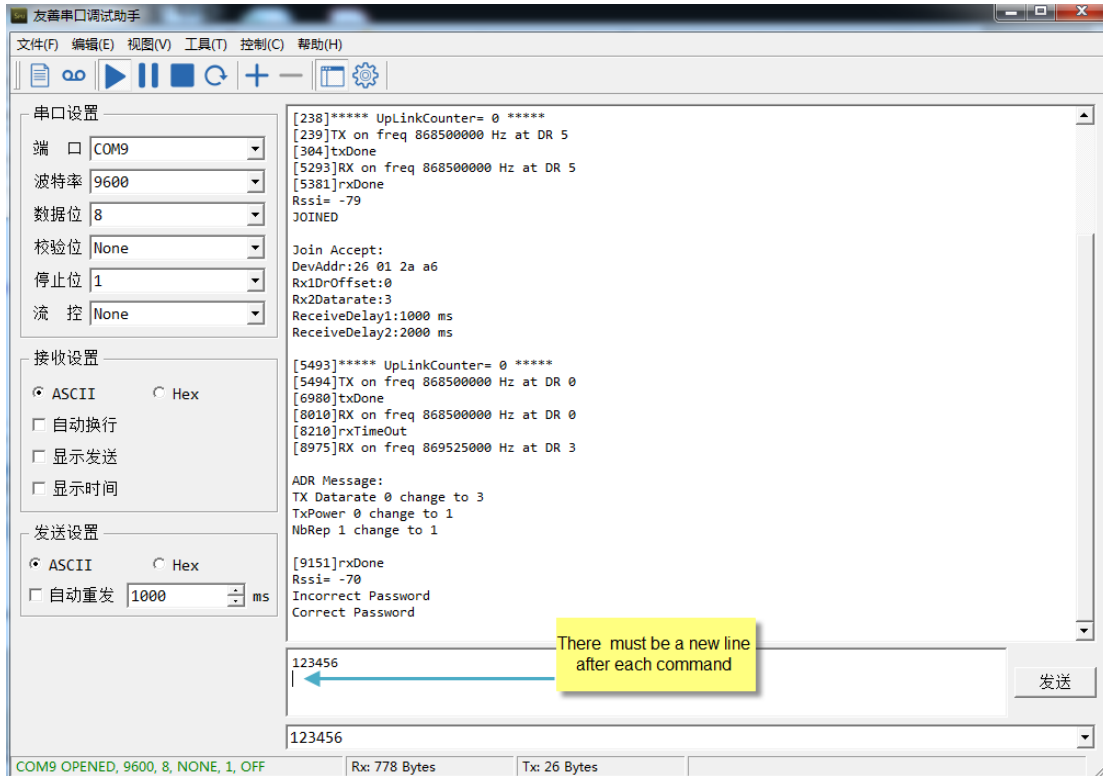

Below are the available commands, a more detailed AT Command manual can be found at

[AT Command Manual:](#)

http://www.dragino.com/downloads/index.php?dir=LoRa_End_Node/LDDS20/

AT+<CMD>?	: Help on <CMD>
AT+<CMD>	: Run <CMD>
AT+<CMD>=<value>	: Set the value
AT+<CMD>=?	: Get the value

General Commands

AT	: Attention
AT?	: Short Help
ATZ	: MCU Reset
AT+TDC	: Application Data Transmission Interval

Keys, IDs and EUIs management

AT+APPEUI	: Application EUI
AT+APPKEY	: Application Key
AT+APPSKEY	: Application Session Key
AT+DADDR	: Device Address
AT+DEUI	: Device EUI
AT+NWKID	: Network ID (You can enter this command change only after successful network connection)
AT+NWKSKEY	: Network Session Key Joining and sending date on LoRa network
AT+CFM	: Confirm Mode
AT+CFS	: Confirm Status
AT+JOIN	: Join LoRa? Network
AT+NJM	: LoRa? Network Join Mode
AT+NJS	: LoRa? Network Join Status
AT+RECV	: Print Last Received Data in Raw Format

AT+RECVB : Print Last Received Data in Binary Format
 AT+SEND : Send Text Data
 AT+SENB : Send Hexadecimal Data

LoRa Network Management

AT+ADR : Adaptive Rate
 AT+CLASS : LoRa Class(Currently only support class A)
 AT+DCS : Duty Cycle Setting
 AT+DR : Data Rate (Can Only be Modified after ADR=0)
 AT+FCD : Frame Counter Downlink
 AT+FCU : Frame Counter Uplink
 AT+JN1DL : Join Accept Delay1
 AT+JN2DL : Join Accept Delay2
 AT+PNM : Public Network Mode
 AT+RX1DL : Receive Delay1
 AT+RX2DL : Receive Delay2
 AT+RX2DR : Rx2 Window Data Rate
 AT+RX2FQ : Rx2 Window Frequency
 AT+TXP : Transmit Power

Information

AT+RSSI : RSSI of the Last Received Packet
 AT+SNR : SNR of the Last Received Packet
 AT+VER : Image Version and Frequency Band
 AT+FDR : Factory Data Reset
 AT+PORT : Application Port
 AT+CHS : Get or Set Frequency (Unit: Hz) for Single Channel Mode
 AT+CHE : Get or Set eight channels mode, Only for US915, AU915, CN470

3.2Set Interrupt Mode

Feature, Set Interrupt mode for GPIO_EXIT.

AT Command: AT+INTMOD

Command Example	Function	Response
AT+INTMOD=?	Show current interrupt mode	0 OK the mode is 0 = No interruption
AT+INTMOD=2	Set Transmit Interval 0- (Disable Interrupt), 1- (Trigger by rising and falling edge), 2- (Trigger by falling edge) 3- (Trigger by rising edge)	OK Set transmit interval to 60000ms = 60 seconds

Downlink Command: 0x06

Format: Command Code (0x06) followed by 3 bytes.

This means that the interrupt mode of the end node is set to 0x000003=3 (rising edge trigger), and the type code is 06.

➤ Example 1: Downlink Payload: 06000000 // Turn off interrupt mode

- Example 2: Downlink Payload: 06000003 // Set the interrupt mode to rising edge trigger

4. FAQ

4.1 What is the frequency plan for LDDS20?

LDDS20 use the same frequency as other Dragino products. User can see the detail from this link:

http://wiki.dragino.com/index.php?title=End_Device_Frequency_Band#Introduction

4.2 How to change the LoRa Frequency Bands/Region?

You can follow the instructions for [how to upgrade image](#).

When downloading the images, choose the required image file for download.

5. Trouble Shooting

5.1 Why I can't join TTN V3 in US915 / AU915 bands?

It is due to channel mapping. Please see below link:

http://wiki.dragino.com/index.php?title=LoRaWAN_Communication_Debug#Notice_of_US915.2FCN470.2FAU915_Frequency_band

5.2 AT Command input doesn't work

In the case if user can see the console output but can't type input to the device. Please check if you already include the **ENTER** while sending out the command. Some serial tool doesn't send **ENTER** while press the send key, user need to add ENTER in their string.

6. Order Info

Part Number: **LDDS20-XX**

XX: The default frequency band

- **AS923**: LoRaWAN AS923 band
- **AU915**: LoRaWAN AU915 band
- **EU433**: LoRaWAN EU433 band
- **EU868**: LoRaWAN EU868 band
- **KR920**: LoRaWAN KR920 band
- **US915**: LoRaWAN US915 band
- **IN865**: LoRaWAN IN865 band
- **CN470**: LoRaWAN CN470 band

7. Packing Info

Package Includes:

- LDDS20 LoRaWAN Liquid Level Sensor x 1

Note:

Ultrasonic coupling paste and Eproxy AB glue are subjected in most shipping way. So the default package doesn't include it and user needs to purchase locally.

Dimension and weight:

- Device Size: cm
- Device Weight: g
- Package Size / pcs : cm
- Weight / pcs : g

8. Support

- Support is provided Monday to Friday, from 09:00 to 18:00 GMT+8. Due to different timezones we cannot offer live support. However, your questions will be answered as soon as possible in the before-mentioned schedule.
- Provide as much information as possible regarding your enquiry (product models, accurately describe your problem and steps to replicate it etc) and send a mail to

support@dragino.com