

DDS75-NB -- NB-LoT Distance Detection Sensor User Manual

Last modified by Mengting Qiu (/xwiki/bin/view/XWiki/ting) on 2023/11/02 11:17



Table of Contents:

- 1. Introduction
 - 1.1 What is DDS75-NB NB-LoT Distance Detection Sensor
 - 1.2 Features
 - 1.3 Specification
 - 1.4 Rated environmental conditions
 - 1.5 Effective measurement range Reference beam pattern
 - 1.6 Applications
 - 1.7 Sleep mode and working mode
 - 1.8 Button & LEDs
 - 1.9 BLE connection
 - 1.10 Pin Definitions & Switch
 - 1.10.1 Jumper JP2
 - 1.10.2 BOOT MODE / SW1
 - 1.10.3 Reset Button
 - 1.11 Mechanical
- 2. Use DDS75-NB to communicate with IoT Server
 - 2.1 Send data to IoT server via NB-LoT network
 - 2.2 Payload Types
 - 2.2.1 General Json Format(Type=5)
 - 2.2.2 HEX format Payload(Type=0)
 - 2.2.3 ThingsBoard Payload(Type=3)
 - 2.2.4 ThingSpeak Payload(Type=1)
 - 2.3 Uplink Payload
 - 2.3.1 Battery Info
 - 2.3.2 Interrupt
 - 2.3.3 Distance
 - 2.4 Test Uplink and Change Update Interval
 - 2.5 Multi-Samplings and One uplink
 - 2.6 Trggier an uplink by external interrupt
- 3. Configure DDS75-NB
 - 3.1 Configure Methods
 - 3.2 AT Commands Set

- 4. Battery & Power Consumption
- 5. Firmware update
- 6. FAQ
 - 6.1 How can I access the BC660K-GL AT Commands?
 - 6.2 Can I use DDS75-NB in condensation environment?
- 7. Trouble Shooting
 - 7.1 Why does the sensor reading show 0 or "No sensor"?
 - 7.2 Abnormal readings The gap between multiple readings is too large or the gap between the readings and the actual value is too large
- 8. Order Info
- 9. Packing Info
- 10. Support

1. Introduction

1.1 What is DDS75-NB NB-IoT Distance Detection Sensor

The Dragino DDS75-NB is a **NB-IoT Distance Detection Sensor** for Internet of Things solution. It is used to measure the distance between the sensor and a flat object. The detection sensor is a module that uses **ultrasonic sensing technology** for distance measurement, and **temperature compensation** is performed internally to improve accuracy. The DDS75-NB can be applied to scenarios such as horizontal distance measurement, liquid level measurement, parking management system, object proximity and pres-intelligent trash can management system, robot obstacle avoidance, automatic control, sewer, bottom water level monitoring, etc.

It detects the distance **between the measured object and the sensor**, and sends IoT platform via NB-IoT network.

DDS75-NB supports different uplink methods including **MQTT, MQTTs, UDP & TCP** for different application requirements, and supports uplinks to various IoT Servers.

DDS75-NB **supports BLE configure** and **OTA update** which make user easy to use.

DDS75-NB is powered by **8500mAh Li-SOCI2 battery**, it is designed for long-term use up to several years.

DDS75-NB has optional built-in SIM card and default IoT server connection version. Which makes it work with simple configuration.

DDS75-NB in a NB-IoT Network

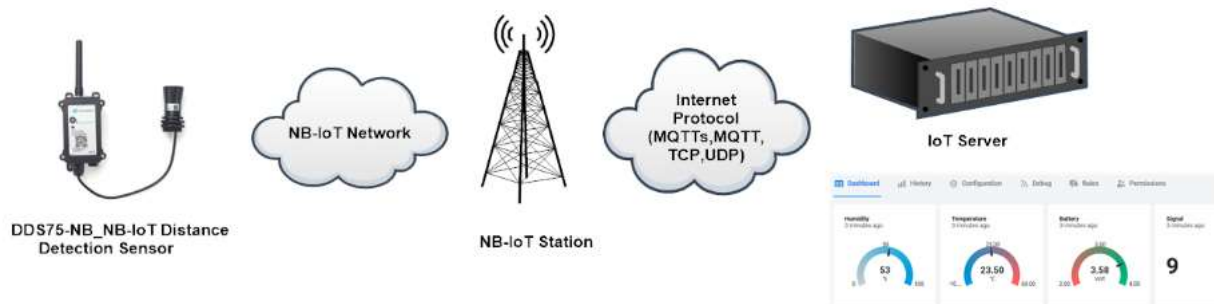

1.2 Features

- NB-IoT Bands: B1/B2/B3/B4/B5/B8/B12/B13/B17/B18/B19/B20/B25/B28/B66/B70/B85 @H-FDD
- Ultra-low power consumption
- Distance Detection by Ultrasonic technology
- Flat object range 280mm - 7500mm
- Accuracy: $\pm(1\text{cm}+S*0.3\%)$ (S: Distance)
- Measure Angle: 40°
- Multiply Sampling and one uplink
- Support Bluetooth v5.1 remote configure and update firmware
- Uplink on periodically
- Downlink to change configure
- IP66 Waterproof Enclosure
- 8500mAh Battery for long term use
- Nano SIM card slot for NB-IoT SIM

1.3 Specification

Common DC Characteristics:

- Supply Voltage: 2.5v ~ 3.6v
- Operating Temperature: -40 ~ 85°C

NB-IoT Spec:

NB-IoT Module: BC660K-GL

Support Bands:

- B1 @H-FDD: 2100MHz
- B2 @H-FDD: 1900MHz
- B3 @H-FDD: 1800MHz
- B4 @H-FDD: 2100MHz
- B5 @H-FDD: 860MHz
- B8 @H-FDD: 900MHz
- B12 @H-FDD: 720MHz
- B13 @H-FDD: 740MHz
- B17 @H-FDD: 730MHz
- B18 @H-FDD: 870MHz
- B19 @H-FDD: 870MHz
- B20 @H-FDD: 790MHz
- B25 @H-FDD: 1900MHz
- B28 @H-FDD: 750MHz
- B66 @H-FDD: 2000MHz
- B70 @H-FDD: 2000MHz
- B85 @H-FDD: 700MHz

Battery:

- Li/SOCI2 un-chargeable battery
- Capacity: 8500mAh
- Self Discharge: <1% / Year @ 25°C
- Max continuously current: 130mA
- Max boost current: 2A, 1 second

Power Consumption

- STOP Mode: 10uA @ 3.3v
- Max transmit power: 350mA@3.3v

1.4 Rated environmental conditions

Item	Minimum value	Typical value	Maximum value	Unit	Remarks
Storage temperature	-25	25	80	°C	
Storage humidity		65%	90%	RH	(1)
Operating temperature	-15	25	60	°C	
Working humidity		65%	80%	RH	(1)

Remarks: (1) a. When the ambient temperature is 0-39 °C, the maximum humidity is 90% (non-condensing);

b. When the ambient temperature is 40-50 °C, the highest humidity is the highest humidity in the natural world at the current temperature (no con

1.5 Effective measurement range Reference beam pattern

1. The tested object is a white cylindrical tube made of PVC, with a height of 100cm and a diameter of 7.5cm.

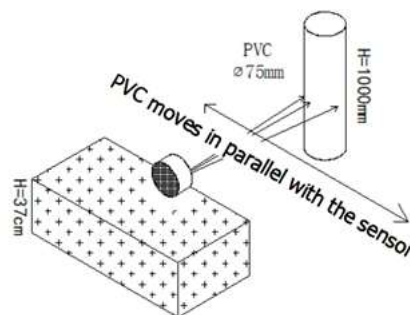
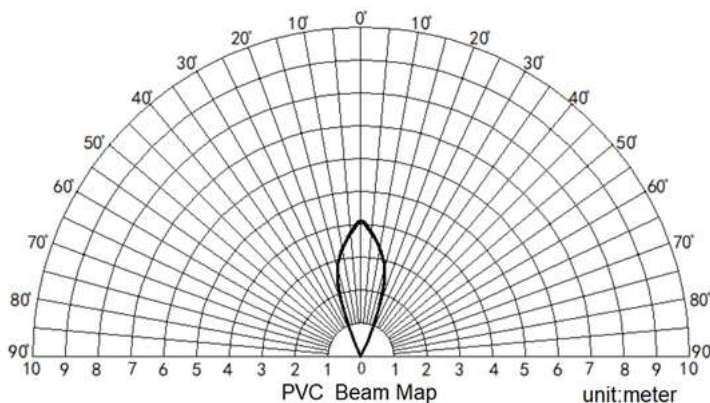

2. The object to be tested is a "corrugated cardboard box" perpendicular to the central axis of 0°, and the length * width is 60cm * 50cm.

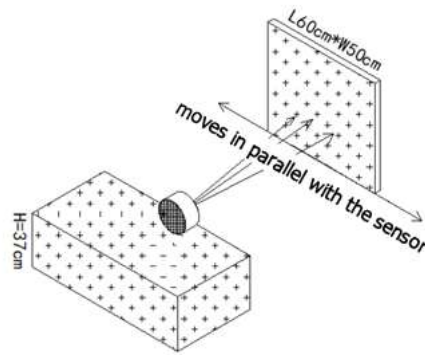
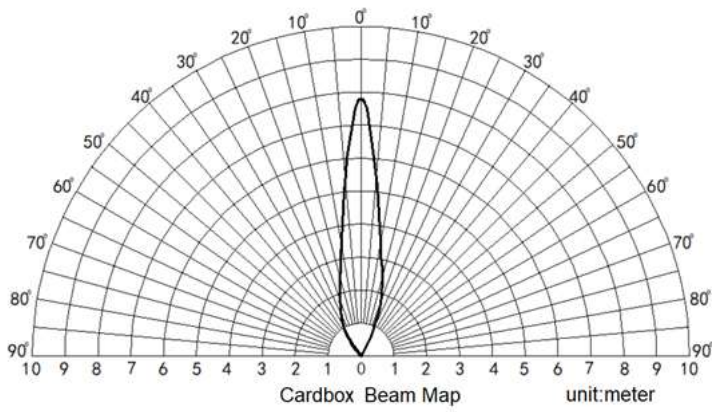

1.6 Applications

- Horizontal distance measurement
- Liquid level measurement
- Parking management system
- Object proximity and presence detection
- Intelligent trash can management system
- Robot obstacle avoidance
- Automatic control
- Sewer
- Bottom water level monitoring

1.7 Sleep mode and working mode

Deep Sleep Mode: Sensor doesn't have any NB-IoT activate. This mode is used for storage and shipping to save battery life.

Working Mode: In this mode, Sensor will work as NB-IoT Sensor to Join NB-IoT network and send out sensor data to server. Between each sampling/tx/rx periodically, sensor has the same power consumption as Deep Sleep mode.

1.8 Button & LEDs

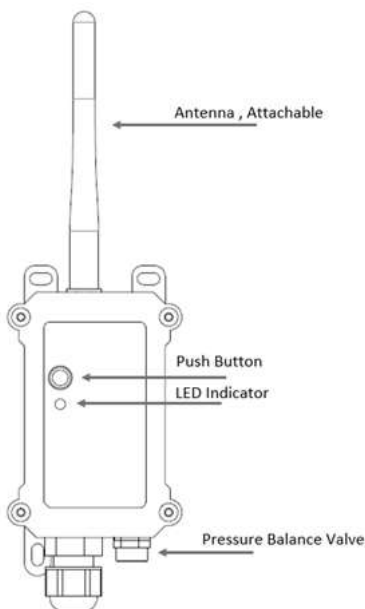

Behavior on ACT	Function	Action
Pressing ACT between 1s < time < 3s	Send an uplink	If sensor has already attached to NB-IoT network, sensor will send an uplink packet, blue led will blink once. Meanwhile, BLE module will be active and user can connect via BLE to configure device.

Pressing ACT for more than 3s	Active Device	<p>Green led will fast blink 5 times, device will enter OTA mode for 3 seconds. And then start to attach NB-IoT network.</p> <p>Green led will solidly turn on for 5 seconds after joined in network.</p> <p>Once sensor is active, BLE module will be active and user can connect via BLE to configure device, no matter if device attach NB-IoT network or not.</p>
Fast press ACT 5 times.	Deactivate Device	<p>Red led will solid on for 5 seconds. Means device is in Deep Sleep Mode.</p>

Note: When the device is executing a program, the buttons may become invalid. It is best to press the buttons after the device has completed the program execution.

1.9 BLE connection

DDS75-NB support BLE remote configure and firmware update.

BLE can be used to configure the parameter of sensor or see the console output from sensor. BLE will be only activate on below case:

- Press button to send an uplink
- Press button to active device.
- Device Power on or reset.

If there is no activity connection on BLE in 60 seconds, sensor will shut down BLE module to enter low power mode.

1.10 Pin Definitions & Switch

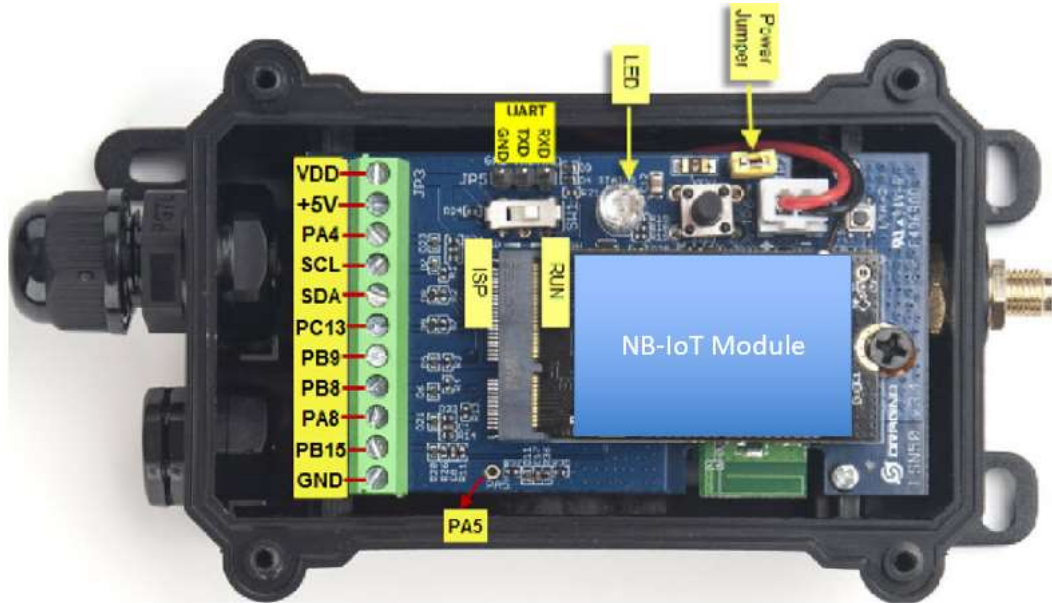

1.10.1 Jumper JP2

Power on Device when put this jumper.

1.10.2 BOOT MODE / SW1

- 1) **ISP:** upgrade mode, device won't have any signal in this mode. but ready for upgrade firmware. LED won't work. Firmware won't run.
- 2) **Flash:** work mode, device starts to work and send out console output for further debug

1.10.3 Reset Button

Press to reboot the device.

1.11 Mechanical

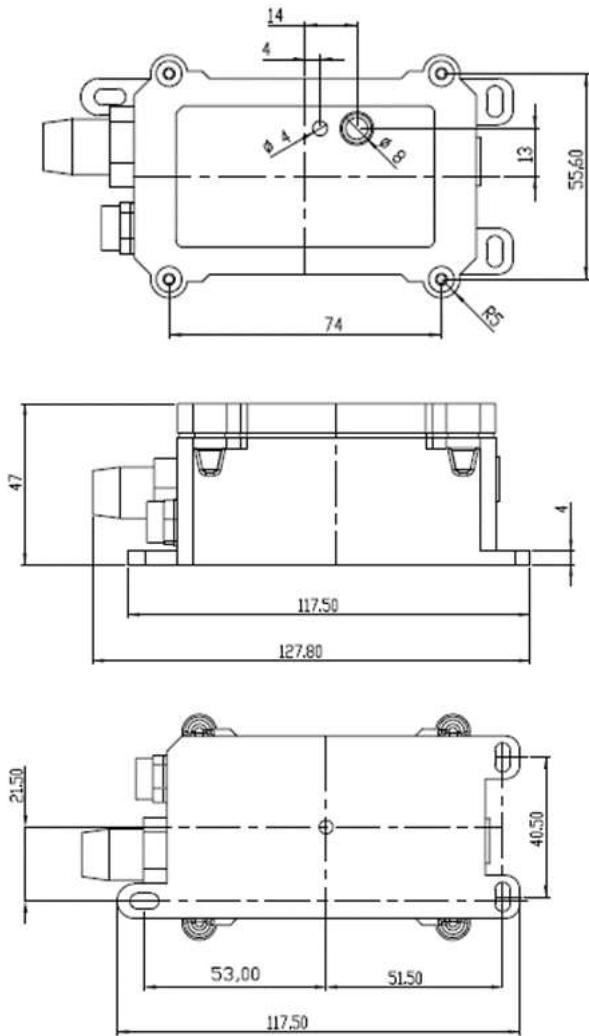

Probe Mechanical:

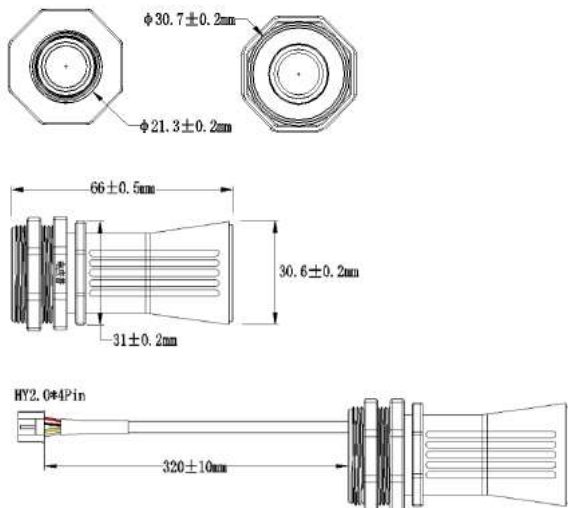

2. Use DDS75-NB to communicate with IoT Server

2.1 Send data to IoT server via NB-IoT network

The DDS75-NB is equipped with a NB-IoT module, the pre-loaded firmware in DDS75-NB will get environment data from sensors and send the value to local NB-IoT network module. The NB-IoT network will forward this value to IoT server via the protocol defined by DDS75-NB.

Below shows the network structure:

DDS75-NB in a NB-IoT Network

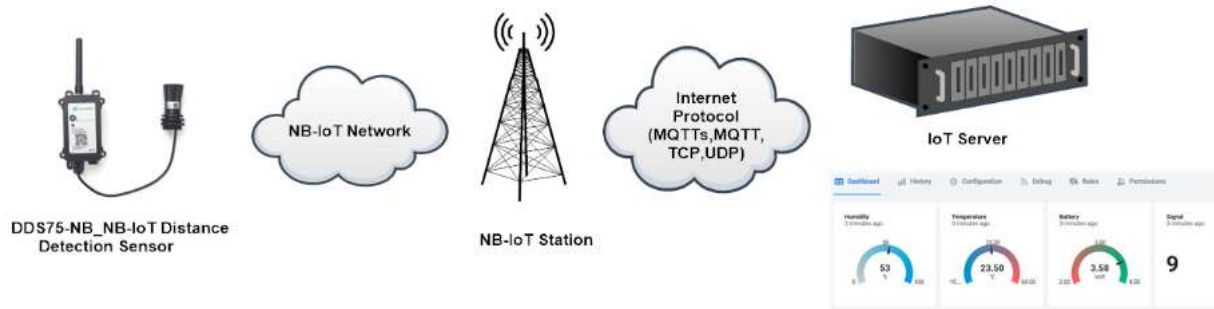

There are two version: **-GE** and **-1D** version of DDS75-NB.

GE Version: This version doesn't include SIM card or point to any IoT server. User needs to use AT Commands to configure below two steps to set DDS75-NB send data

- Install NB-IoT SIM card and configure APN. See instruction of Attach Network (<http://wiki.dragino.com/xwiki/bin/view/Main/General%20Configure%20to%20Connect%20to%20IoT%20server%20for%20NB%20%26%20NS%20NB-IoT%20models/#H2.AttachNetwork>) .
- Set up sensor to point to IoT Server. See instruction of Configure to Connect Different Servers (<http://wiki.dragino.com/xwiki/bin/view/Main/General%20Configure%20to%20Connect%20to%20IoT%20server%20for%20NB%20%26%20NS%20NB-IoT%20models/#H3.Configuretoconnecttodifferentservers>) .

Below shows result of different server as a glance.

Servers	Dash Board	Comments
Node-Red (http://wiki.dragino.com/xwiki/bin/view/Main/General%20Configure%20to%20Connect%20to%20IoT%20server%20for%20NB%20%26%20NS%20NB-IoT%20models/#H3.5A0Node-RedA028viaA0MQTT29)		
DataCake (http://wiki.dragino.com/xwiki/bin/view/Main/General%20Configure%20to%20Connect%20to%20IoT%20server%20for%20NB%20%26%20NS%20NB-IoT%20models/#H3.4Datacake)		
Tago.IO (http://wiki.dragino.com/xwiki/bin/view/Main/General%20Configure%20to%20Connect%20to%20IoT%20server%20for%20NB%20%26%20NS%20NB-IoT%20models/#H3.7A0Tago.ioA028viaA0MQTT29)		
General UDP (http://wiki.dragino.com/xwiki/bin/view/Main/General%20Configure%20to%20Connect%20to%20IoT%20server%20for%20NB%20%26%20NS%20NB-IoT%20models/#H3.1GeneralA0UDPA0Connection)	Raw Payload. Need Developer to design Dash Board	
General MQTT (http://wiki.dragino.com/xwiki/bin/view/Main/General%20Configure%20to%20Connect%20to%20IoT%20server%20for%20NB%20%26%20NS%20NB-IoT%20models/#H3.2GeneralA0MQTTA0connection)	Raw Payload. Need Developer to design Dash Board	
ThingSpeak (http://wiki.dragino.com/xwiki/bin/view/Main/General%20Configure%20to%20Connect%20to%20IoT%20server%20for%20NB%20%26%20NS%20NB-IoT%20models/#H3.3A0ThingSpeakA028viaA0MQTT29)		
ThingsBoard (http://wiki.dragino.com/xwiki/bin/view/Main/General%20Configure%20to%20Connect%20to%20IoT%20server%20for%20NB%20%26%20NS%20NB-IoT%20models/#H3.6A0ThingsBoard.CloudA028viaA0MQTT29)		

1D Version: This version has 1NCE SIM card pre-installed and configure to send value to DataCake. User Just need to select the sensor type in DataCake and Activate [will be able to see data in DataCake. See here for DataCake Config Instruction (<http://wiki.dragino.com/xwiki/bin/view/Main/General%20Configure%20to%20Connect%20to%20IoT%20server%20for%20NB%20%26%20NS%20NB-IoT%20models/#>)

2.2 Payload Types

To meet different server requirement, DDS75-NB supports different payload type.

Includes:

- General JSON format payload. (Type=5)
- HEX format Payload. (Type=0)
- ThingSpeak Format. (Type=1)
- ThingsBoard Format. (Type=3)

User can specify the payload type when choose the connection protocol. Example:

AT+PRO=2,0 // Use UDP Connection & hex Payload

AT+PRO=2,5 // Use UDP Connection & Json Payload

AT+PRO=3,5 // Use MQTT Connection & Json Payload

2.2.1 General Json Format(Type=5)

This is the General Json Format. As below:

```
{
  "IMEI": "866207058378443",
  "Model": "DDS75-NB",
  "distance": 396,
  "battery": 3.50,
  "signal": 22,
  "1": {748,2023/09/21 08:36:55},
  "2": {911,2023/09/21 07:44:35},
  "3": {702,2023/09/21 07:07:19},
  "4": {705,2023/09/21 06:52:19},
  "5": {705,2023/09/21 06:37:19},
  "6": {705,2023/09/21 06:20:49},
  "7": {256,2023/09/21 02:49:51},
  "8": {221,2023/09/20 09:47:01}
}
```

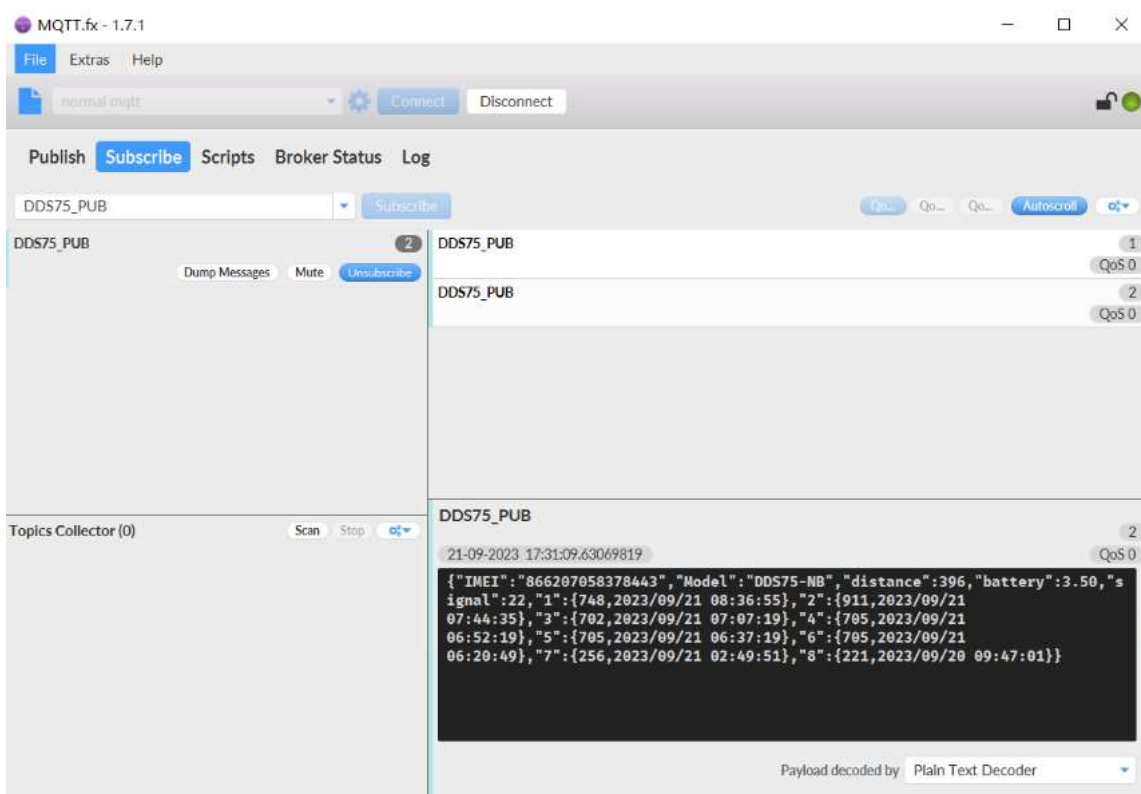

Notice, from above payload:

- Distance , Battery & Signal are the value at uplink time.
- Json entry 1 ~ 8 are the last 1 ~ 8 sampling data as specify by **AT+NOUD=8** Command. Each entry includes (from left to right): Temperature, Humidity, Sampling ti

2.2.2 HEX format Payload(Type=0)

This is the HEX Format. As below:

f86620705837844309640db41201000159650c02e702ec650c00a7038f650bf46302be650beba702c1650be82302c1650be49f02c1650be0c10100650baf4f00dd650abf1

HEX Format for DDS75-NB (AT+NOUD=8)		0964	0df4	11	01	00	0138	64f02eb0
f866207058386669		Version	BAT	Singal	Mod	Interrupt	Distance	Timestamp
8 Bytes								
0000	64efe919	000064efe868	000064efe79d	000064efe6e9				
Distance	Timestamp	last 2nd data	last 3rd data	last 4th data				
6 Bytes		6 Bytes		6 Bytes				
000064efe835	000064efe581	000064efe4cd	000064efe419					
last 5th data	last 6th data	last 7th data	last 8th data					
6 Bytes		6 Bytes		6 Bytes				

If we use the MQTT client to subscribe to this MQTT topic, we can see the following information when the NB sensor uplink data.

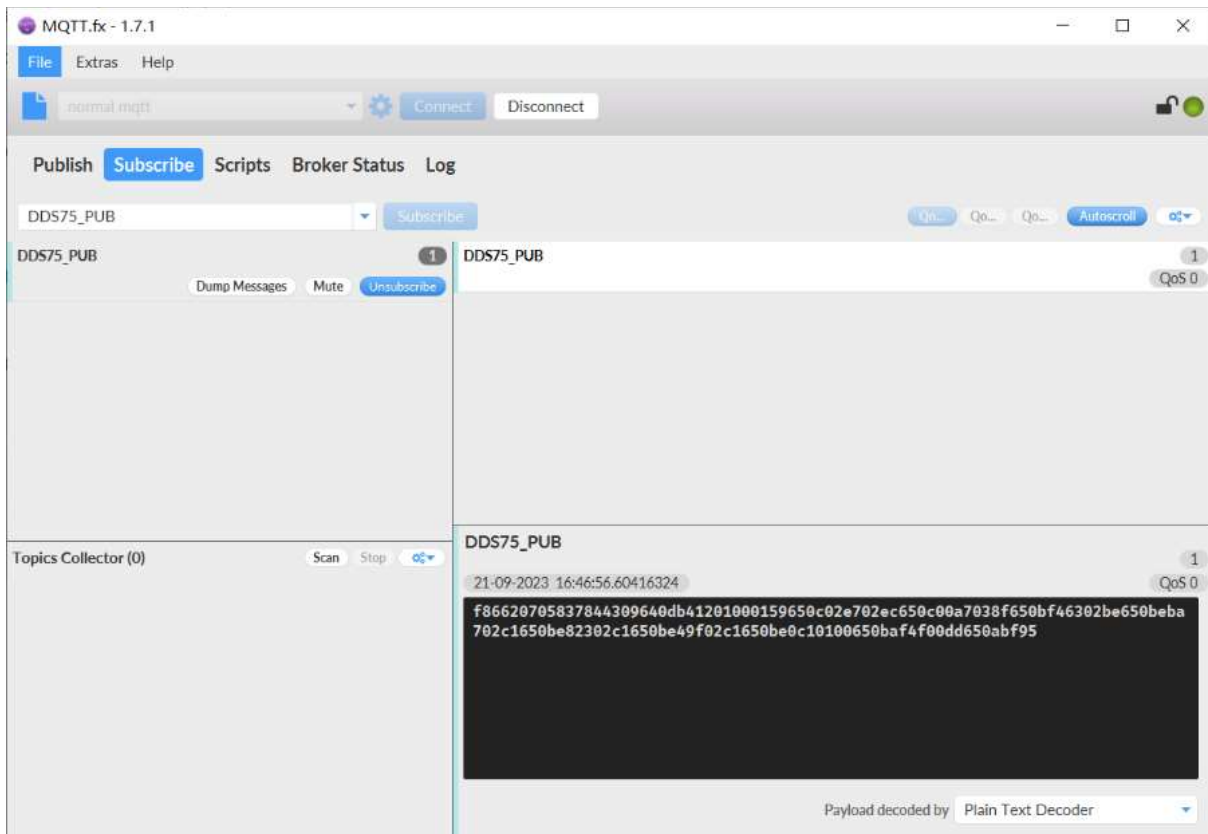

Version:

These bytes include the hardware and software version.

Higher byte: Specify Sensor Model: 0x09 for DDS75-NB

Lower byte: Specify the software version: 0x64=100, means firmware version 1.0.0

BAT (Battery Info):

Ex1: 0x0DB4 = 3508mV

Signal Strength:

NB-IoT Network signal Strength.

Ex1: 0x12 = 18

0 -113dBm or less

1 -111dBm

2...30 -109dBm... -53dBm

31 -51dBm or greater

99 Not known or not detectable

Distance:

Ex1: 0x00fb = 251mm

Timestamp:

Unit Timestamp Example: 650c0af9(H) = 1695288057(D)

Put the decimal value into this link(<https://www.epochconverter.com>) (<https://www.epochconverter.com>)) to get the time.

2.2.3 ThingsBoard Payload(Type=3)

Type3 payload special design for ThingsBoard, it will also configure other default server to ThingsBoard.

```
{"IMEI": "866207058378443", "Model": "DDS75-NB", "distance": 491, "battery": 3.57, "signal": 22}
```

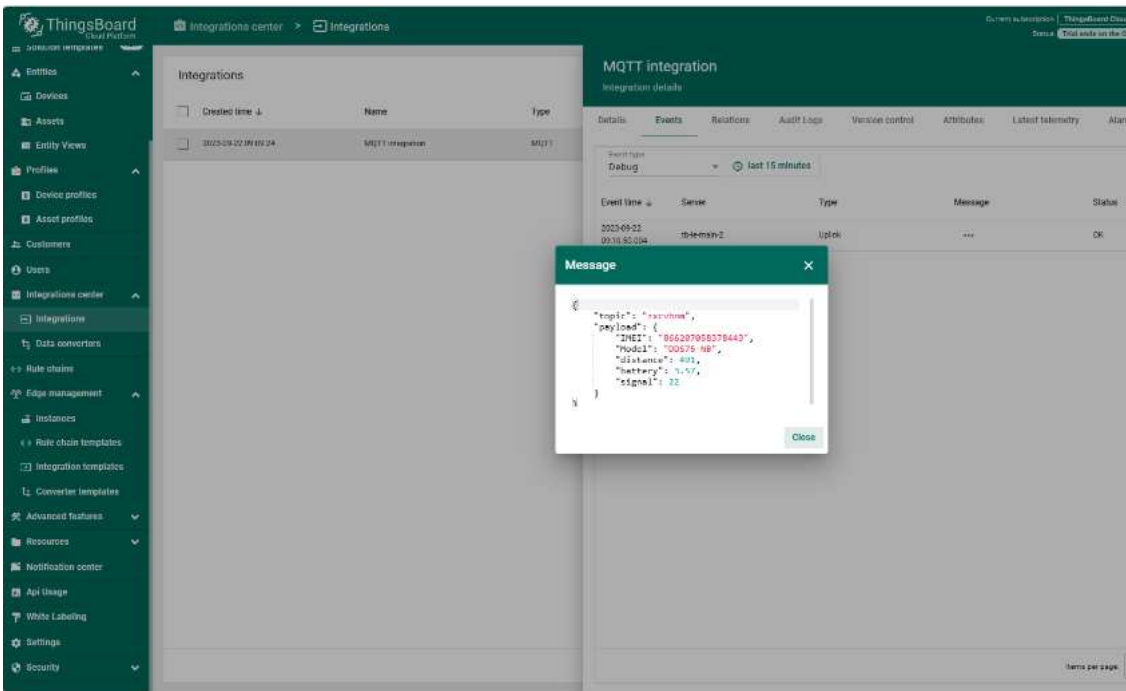

2.2.4 ThingSpeak Payload(Type=1)

This payload meets ThingSpeak platform requirement. It includes only four fields. Form 1~3 are:

Distance, Battery & Signal. This payload type only valid for ThingsSpeak Platform.

As below:

field1=Distance value&field2=Battery value&field3=Signal value

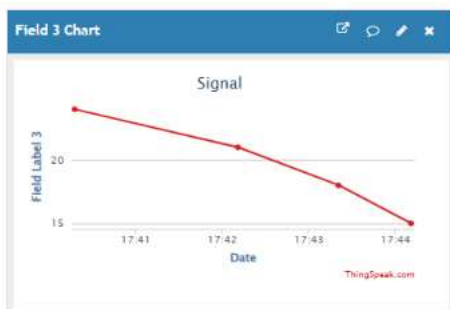

2.3 Uplink Payload

DDS75-NB will uplink payload via NB-IoT with below payload format:

Uplink payload includes in total 21 bytes.

Size(bytes)	8	2	2	1	1	1	2	4
Value	f+IMEI	Ver	BAT	Signal Strength	Mod	Digital Interrupt	Distance(unit: mm)	Timestamp

If the cache upload mechanism is turned on, you will receive the payload shown in the figure below.

Frame header	Frame data(1)	Frame data(2)	F...	Frame data(X)
--------------	---------------	---------------	------	---------------

2.3.1 Battery Info

Check the battery voltage for DDS75-NB.

Ex1: 0x0B45 = 2885mV

Ex2: 0x0B49 = 2889mV

2.3.2 Interrupt

This data field shows if this packet is generated by interrupt or not.

Example:

0x00: Normal uplink packet.

0x01: Interrupt Uplink Packet.

2.3.3 Distance

Get the distance. Flat object range 280mm - 7500mm.

For example, if the data you get from the register is **0x0B 0x05**, the distance between the sensor and the measured object is

0B05(H) = 2821 (D) = 2821 mm.

- If the sensor value is 0x0000, it means system doesn't detect ultrasonic sensor.
- If the sensor value lower than 0x0118 (280mm), the sensor value will be invalid. All value lower than 280mm will be set to 0x0014(20mm) which means the value is

2.4 Test Uplink and Change Update Interval

By default, Sensor will send uplinks **every 2 hours** & AT+NOUD=8

User can use below commands to change the **uplink interval**.

AT+TDC=600 // Set Update Interval to 600s

User can also push the button for more than 1 seconds to activate an uplink.

2.5 Multi-Samplings and One uplink

To save battery life, DDS75-NB will sample distance data every 15 minutes and send one uplink every 2 hours. So each uplink it will include 8 stored data + 1 real-time data by:

- **AT+TR=900** // The unit is seconds, and the default is to record data once every 900 seconds (15 minutes, the minimum can be set to 180 seconds)
- **AT+NOUD=8** // The device uploads 8 sets of recorded data by default. Up to 32 sets of record data can be uploaded.

The diagram below explains the relationship between TR, NOUD, and TDC more clearly:

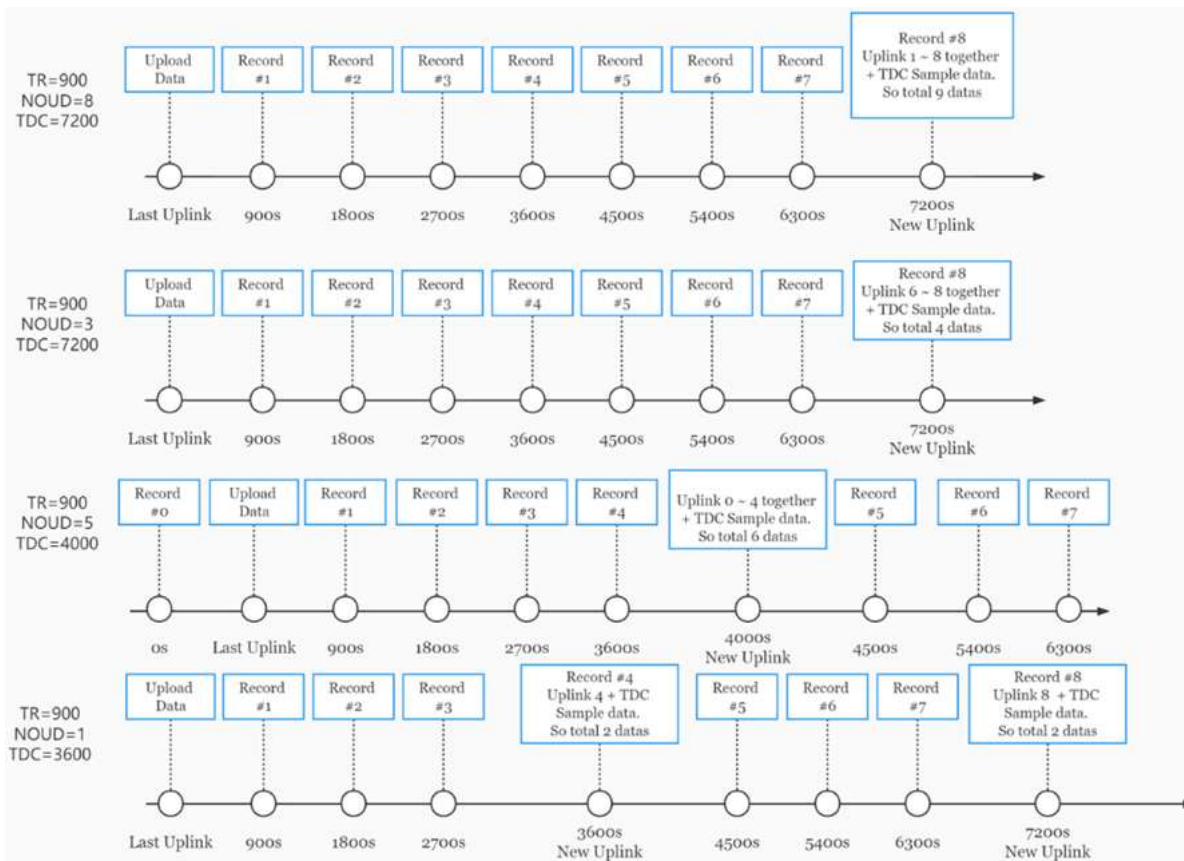

2.6 Trggier an uplink by external interrupt

DDS75-NB has an external trigger interrupt function. Users can use the PB15 pin to trigger the upload of data packets.

AT command:

- **AT+INTMOD** // Set the trigger interrupt mode
- **AT+INTMOD=0** // Disable Interrupt
- **AT+INTMOD=1** // Trigger by rising and falling edge
- **AT+INTMOD=2** // Trigger by falling edge
- **AT+INTMOD=3** // Trigger by rising edge

3. Configure DDS75-NB

3.1 Configure Methods

DDS75-NB supports below configure method:

- AT Command via Bluetooth Connection (**Recommended**): BLE Configure Instruction (<http://wiki.dragino.com/xwiki/bin/view/Main/BLE%20Bluetooth%20Remote%20Access%20Instruction>)
- AT Command via UART Connection : See UART Connection (<http://wiki.dragino.com/xwiki/bin/view/Main/UART%20Access%20for%20LoRa%20ST%20v4%20base%20model/#H2.3UARTConnectionforSN50v3basemotherboard>)

3.2 AT Commands Set

AT+<CMD>? : Help on <CMD>
 AT+<CMD> : Run <CMD>
 AT+<CMD>=<value> : Set the value
 AT+<CMD>=? : Get the value

General Commands

AT : Attention
 AT? : Short Help
 ATZ : MCU Reset
 AT+TDC : Application Data Transmission Interval
 AT+CFG : Print all configurations
 AT+CFGMOD : Working mode selection

AT+DEUI : Get or set the Device ID
AT+INTMOD : Set the trigger interrupt mode
AT+5VT : Set extend the time of 5V power
AT+PRO : Choose agreement
AT+RXDL : Extend the sending and receiving time
AT+DNSCFG : Get or Set DNS Server
AT+GETSENSORVALUE : Returns the current sensor measurement
AT+NOUD : Get or Set the number of data to be uploaded
AT+CDP : Read or Clear cached data
AT+SHTEMP: Get or Set alarm of temp
AT+SHHUM: Get or Set alarm of moisture
AT+SERVADDR : Server Address

UDP Management

AT+CFM : Upload confirmation mode (only valid for UDP)

MQTT Management

AT+CLIENT : Get or Set MQTT client
AT+UNAME : Get or Set MQTT Username
AT+PWD : Get or Set MQTT password
AT+PUBTOPIC : Get or Set MQTT publish topic
AT+SUBTOPIC : Get or Set MQTT subscription topic

Information

AT+FDR : Factory Data Reset
AT+PASSWORD : Serial Access Password
AT+LDATA : Get the last upload data
AT+CDP : Read or Clear cached data

4. Battery & Power Consumption

DDS75-NB use ER26500 + SPC1520 battery pack. See below link for detail information about the battery info and how to replace.

Battery Info & Power Consumption Analyze (<http://wiki.dragino.com/xwiki/bin/view/Main/How%20to%20calculate%20the%20battery%20life%20of%20Dragino%20sens>)

5. Firmware update

User can change device firmware to::

- Update with new features.
- Fix bugs.

Firmware and changelog can be downloaded from : **Firmware download link** (<https://www.dropbox.com/sh/spr33jrw3x45qnm/AADljOsDG-DesaL2WwTWSV55a?dl=1>)

Methods to Update Firmware:

- (Recommended way) OTA firmware update via BLE: **Instruction** (http://wiki.dragino.com/xwiki/bin/view/Main/BLE_Firmware_Update_NB_Sensors_BC660K-GL/)
- Update through UART TTL interface : **Instruction** (<http://8.211.40.43/xwiki/bin/view/Main/Firmware%20Upgrade%20Instruction%20for%20STM32%20base%20products/#H4.2.FirmwareupgradeusingSTM32>)

6. FAQ

6.1 How can I access t BC660K-GL AT Commands?

User can access to BC660K-GL directly and send AT Commands.

See BC660K-GL AT Command set (<https://www.dropbox.com/sh/5f6ssda5fum8rvs/AABT68l8ZzWOvZ5eg2qwOoFda?dl=0>)

6.2 Can I use DDS75-NB in condensation environment?

DDS75-NB is not suitable to be used in condensation environment. Condensation on the DDS75-NB probe will affect the reading and always got 0.

7. Trouble Shooting

7.1 Why does the sensor reading show 0 or "No sensor"

1. The measurement object is very close to the sensor, but in the blind spot of the sensor.
2. Sensor wiring is disconnected
3. Not using the correct decoder

7.2 Abnormal readings The gap between multiple readings is too large or the gap between readings and the actual value is too large

- 1) Please check if there is something on the probe affecting its measurement (condensed water, volatile oil, etc.)
- 2) Does it change with temperature, temperature will affect its measurement
- 3) If abnormal data occurs, you can turn on DEBUG mode, Please use downlink or AT COMMAN to enter DEBUG mode.

downlink command: **F1 01**, AT command: **AT+DDEBUG=1**

- 4) After entering the debug mode, it will send 20 pieces of data at a time, and you can send its uplink to us for analysis



Its original payload will be longer than other data. Even though it is being parsed, it can be seen that it is abnormal data.

Please send the data to us for check.

8. Order Info

Part Number: **DDS75-NB-XX**

XX:

- **GE:** General version (Exclude SIM card)
- **1D:** with 1NCE* 10 years 500MB SIM card and Pre-configure to DataCake server

1NCE SIM Card NB-IoT network coverage: Austria, Belgium, Bulgaria, Croatia, Czech Republic, Denmark, Finland, Germany, Great Britain, Greece, Hungary, Ireland, It Netherlands, Norway, Puerto Rico, Russia, Slovak , Republic, Slovenia, Spain, Sweden, Switzerland, Taiwan, USA, US Virgin Islands

9. Packing Info

Package Includes:

- DDS75-NB NB-IoT Distance Detection sensor x 1
- External antenna x 1

Dimension and weight:

- Device Size: 13.0 x 5 x 4.5 cm
- Device Weight: 150g
- Package Size / pcs : 14.0 x 8x 5 cm
- Weight / pcs : 180g

10. Support

- Support is provided Monday to Friday, from 09:00 to 18:00 GMT+8. Due to different timezones we cannot offer live support. However, your questions will be answer possible in the before-mentioned schedule.
- Provide as much information as possible regarding your enquiry (product models, accurately describe your problem and steps to replicate it etc) and send a mail to (mailto:Support@dragino.cc) .

No comments for this page