

User Manual EMU Professional II

Document Reference: 1451

Version: 4.3

Date: 18.07.2023

Inhaltsverzeichnis

1	General	6
	Safety Instructions	6
	Maintenance	6
	Disclaimer / Liability Exclusion	6
	Duties of the Customer	6
	Data & Security Backup	6
	Monitoring Obligation	6
	Access Authorization	7
	Responsibility for the IT-Environment	7
	Declaration of Conformity	7
	Comments	7
2	Scope of Delivery and Reception Inspection	8
3	Product Description	9
	Versions	10
	Measurement Process	10
	Protection against unauthorized alteration of settings	11
	Firmware Versions	11
	Operation Concept	12
	Buttons	12
	Overview Front EMU Professional II	13
	Overview Laserprint Right	14
	Overview Display	15
	Compatible Devices	16
	Installation	17
	Technical Data	18
4	Commissioning / Check-up	19
	Settings ex Factory	19
	Measurements	19
	Connection Diagram Direct Meter	19
	Connection Diagram Converter Counter	20
	Tightening Torque	21
	Spring-Cage Clamps Wire Diameter	21
5	Operation	22
	Main Menu Pages	22
	Sub Menu Pages	23
	Energy	23
	Power and Current	24
	Voltage, Power Factor and Frequency	26
	Load Profile and Logbook	26
	Settings	27
6	Configuration Settings	29
	Language Sprache	29
	Tariff Change	29
	Set Number of Tariffs	29
	Real Time Clock (RTC)	30
	Configuration on the Device	30
	Automatic Synchronization	30
	Load Profile Interval	30
	Configuration of Transformer Ratio	31
	S0 Pulse Ratio	31
	S0 Impulse Duration	31

Configuration of the Energy Display	32
Energy per Tariff:	32
Energy per Phase:	32
Overview	32
7 Configuration Interfaces	33
Interfaces	33
M-Bus	33
Settings ex Factory	33
Connection Diagram M-Bus	34
Configuration of the Primary Address on the Device	34
Configuration of the Secondary Address on the Device	34
Configuration of the Baud Rate on the Device	34
Configuration via MB-Connect	35
S0 Pulse Output	35
Settings ex Factory	35
Connection Diagram S0 Pulse Output	35
Configuration of Read-Out Type	36
Configuration of the Pulse Rate	36
Configuration of the Pulse Duration	36
TCP/IP	36
Settings ex Factory	36
Connection Diagram TCP/IP	37
Configuration and Access	37
ModBus RTU	37
Connection Diagram Modbus	38
Configuration and Access	38
LoRa	38
Settings ex Factory	38
Configuration and Access	38
8 In Case of Errors	39
Possible Errors after Installation	39
Wrong Meter Readings on the Converter Counter	39
Behavior with Export and Import	39
The EMU Professional II Sends Wrong Information on the S0 Interface	40
Tariff Change Does Not Work	40
9 Extended Information for Load Profile According to PTB-A 50.7	41
Measurement Correctness Note	41
Auflagen für den Verwender im Sinne des § 23 der Mess- und Eichverordnung	41
Transparenz der Verwendung	41
Tarifierung	41
Fehlermeldungen / Uhrzeitverstellungen	42
Verwendung der Kommunikationsschnittstellen	42
Zeitsynchronisierung	42
Messergebnisse, die nicht für Verrechnungszwecke verwendet werden dürfen	42
Logbuchfunktion	42
EMU Professional II	43
Current- and Voltage-transformer Ratio	43
Real Time Clock	43
S0 Impulse Output	43
Use for Billing Purposes	43
Description	44
Interval of Recording	44
Time Synchronization	44
Tariff Changes	46
External Read-out over Interfaces	46
Memory Capacity	46
Power Failure and Reboot	46

Display Load Profile	47
Display Logbook	48
In Case of a Time Adjustment	48
In Case of a Ratio Adjustment	48
In Case of a Impulse Duration Adjustment	49
In Case of a Impulse Rate Adjustment	49

Version	Revision Date	Token	Changes
V1.0	25.01.2021	met	Creation of document
V2.0	02.02.2021	met	Structuring, completion
V2.1	18.02.2021	met	Improvements of Translation, Clean up
V2.2	23.03.2021	met	Supplemental information for load profile PTB-A 50.7
V2.4	24.03.2021	met	Messrichtigkeitshinweise added
V2.5	12.04.2021	met	Customer responsibilities added
V2.6	24.06.2021	met	Added: TCP/IP Interface, Update: Number of available Logbook and load profile entries
V2.7	25.06.2021	met	Addition NTP error, fixed error TNP -> NTP, updated notes for S0, converter ratios and RTC
V2.8	01.07.2021	met	restructuring of interfaces. Interfaces have their own document now. Added annotation to new document
V2.9	22.07.2021	met	Aligning with german version. Picture renewal. Tariff note for 4 tariffs. Adjustment of S0 Output
V3.0	21.09.2021	met	Added further warnings regarding converter counter
V3.1	30.09.2021	met	Improved safety instructions. Revamp of NTP, TNV & TNS
V3.2	10.12.2021	met	PTB: Rebootcase added
V3.3	06.04.2022	met	Information on spring-cage clamps specified. Updated LoRa interface
V3.4	13.04.2022	fbo	added further information about energy direction (display)
V3.5	11.05.2022	met	Rework of Doc.Ref numbers. Same document in different language no longer has a different Doc.Ref number
V3.6	09.06.2022	sko	Specification for OEM versions. Address = Manufacturer. E-mail and website = OEM customer
V3.7	28.06.2022	met	Added information about possible measurement errors in Installation, Added visualization of active and reactive energy registers
V4.0	30.11.2022	met	Rework of document structure
V4.1	30.03.2023	met	Added language settings
V4.2	07.07.2023	met	supplemented SRVC button, corrected RMS calculations
V4.3	18.07.2023	met	clarified transformer ratios

General

Safety Instructions

Please read this user manual as well as all other supplementary documents for the EMU Professional II carefully.



Please pay special attention to the safety instructions and warnings when using the EMU Professional II and this user manual. Nonobservance can lead to substantial damage to persons and/or property.

Please use the EMU Professional II only in its certified area of operation. Nonobservance of these boundaries can lead to substantial damage to persons and/or property.

Unauthorized changes to the EMU Professional II voids all warranties and precludes any and all rights for compensation on the part of EMU Electronic AG in case of damage.

The usual local security and work rules must be observed. The installation of the EMU Professional II must be carried out by qualified and trained personnel. Please read the installation instructions carefully.

The following symbols indicate areas where special attention is necessary:

-  This symbol combined with the word "Note:" is used to describe important information, an important procedure or handling.
-  This symbol indicates a potentially dangerous situation where nonobservance of these warnings can lead to substantial damage to persons and/or property.

Maintenance

The EMU Professional II is maintenance free. In case of damages (for example incorrect operation or incorrect storage) repairs may only be carried out by EMU Electronic AG .

Disclaimer / Liability Exclusion

The choice of the EMU energy meter and determination of the suitability of the meter type for a particular purpose are solely the responsibility of the buyer. EMU Electronic AG takes no responsibility for this.

Data / information in catalogs and data sheets do not promise special properties, but are determined by experience and measurements.

Liability for damages caused by improper operation / projecting or malfunction of the energy meter is excluded. The operator / project engineer has to take care that improper operation / planning and malfunctions can not cause further damage. No warranty is given for defects or damage caused by improper use of the EMU energy meter or by not following the manual.

Duties of the Customer

Data & Security Backup

The customer is responsible for a suitable data backup regardless of the type of installation of the EMU Professional II energy meter. The risks and costs of operation lie with the customer. EMU can help with developing possible concepts for operation within the scope of further services.

The responsibility for establishing the required read-out and security-backups for safe operations lie with the customer. The security-backups must be stored securely by the customer.

Monitoring Obligation

The customer is obligated to monitor the EMU Professional II to identify outages of measuring points as soon as possible within the first 24 hours of the outage.

Access Authorization

The customer is responsible for the technical and organizational security against unauthorized third-party involvement for the EMU Professional II energy meter.

Responsibility for the IT-Environment

The customer is responsible for their IT-environment as well as the safeguarding of it's access.

It is brought to the customers attention that the EMU Professional II energy meter as well as it's FW-Updates (Firmware) have certain system requirements. It is the responsibility of the customer to conform to these requirements. It is the exclusive responsibility of the customer to provide the necessary hardware and personnel required for the EMU -Firmware.

The customer is advised to take precautions in case of partial or full failure of the EMU Professional II energy meter (e.g. daily backups, interference diagnosis, regular examination of measurements, contingency plans). It is their sole responsibility to provide necessary infrastructure and ensure functionality of the work environment and it's technical capability.

The initial system requirements can change during operation or due to an update. The customer is responsible for keeping themselves up to date on these requirements and to ensure system compatibility before installing updates. A daily read-out and archiving of load-profiles for the EMU Professional II LP is required.

Declaration of Conformity

For our full declaration of conformity for the EMU Professional II please refer to the document "Declaration of Conformity DE/FR/EN.pdf" which can be downloaded by following the link: https://www.emuag.ch/files/certificate/Declaration_of_conformity_Professional-II_DE_EN_FR.pdf.

Or scan the QR-Code below.



Comments

Your comments regarding this manual are welcome. If you have any questions after consulting this manual, please contact us via e-mail at helpdesk@emuag.ch

Scope of Delivery and Reception Inspection

Scope of delivery:

- A quick-start guide which explains the most important elements of the meter. Please read that guide thoroughly.
- Your EMU Professional II

If your delivery exhibits obvious damages, please contact us immediately via e-mail at helpdesk@emuag.ch. Please attach the serial number of the affected energy meter as well as the corresponding invoice and/or bill of delivery number.

Product Description

The EMU Professional II is:

- to be used as a 3-phase energy meter only.
- intended for static 3-phase measurements of imported and exported active energy according to EN50470-3:2006 in the residential, business and industrial sector.
 - These measurements can be used for billing purposes.
- intended for static 3-phase measurements of imported and exported reactive energy according to EN62053 in the residential, business and industrial sector.
 - These measurements can be used for billing purposes.
- suitable for installation in static, weatherproof control enclosures in buildings.
- deployable in four-wire systems and TN-grids.
- applicable for direct metering for up to 100A in its 3/100 model.
- only applicable for measurements in medium and high voltage grids if used in conjunction with current and voltage transformers.
 - not certified for operation with voltage transformers.
 - only operable with voltage transformer ratios of ../100.
- designed to be used in conjunction with external ../1A or ../5A current transformers in its 3/5 model.
- suitable for use in the residential, business and industrial sector.
- certified for load profile according to PTB-A 20.1 and PTB-A 50.7 in its LP version.

You are able to display the measurement data on the display or read them out over any optional interface.



Note: The LP version of the EMU Professional II is only certified for active energy measurement billing purposes!



Note: A special chapter at the end of this user manual describes the LP version in detail. Information in the chapter "Extended Information for Load Profile According to PTB-A 50.7" supercedes the corresponding information in the this user manual.



Attention: *Improper use of the EMU Professional II can lead to substantial personal and/or property damage.*

Versions

All EMU Professional II are MID B+D certified. Additionally, the LP model is certified for PTB-A 20.1 and PTB-A 50.7.

Article number	Description	Supplementary Information
P20A0000	EMU Professional II 3/100	MID B+D certification
P20A000M	EMU Professional II 3/100 M-Bus	MID B+D certification
P20A000T	EMU Professional II 3/100 TCP/IP	MID B+D certification
P20A000MO	EMU Professional II 3/100 Modbus	MID B+D certification
P20A000LO	EMU Professional II 3/100 LoRa	MID B+D certification
P20A000LE	EMU Professional II 3/100 LoRa ext. Ant.	MID B+D certification
P20A030M	EMU Professional II 3/100 M-Bus LP	MID B+D, PTB-A 20.1 and PTB-A 50.7 certification
P20A030T	EMU Professional II 3/100 TCP/IP LP	MID B+D, PTB-A 20.1 and PTB-A 50.7 certification
P21A0000	EMU Professional II 3/5	MID B+D certification
P21A000M	EMU Professional II 3/5 M-Bus	MID B+D certification
P21A000T	EMU Professional II 3/5 TCP/IP	MID B+D certification
P21A000MO	EMU Professional II 3/5 Modbus	MID B+D certification
P21A000LO	EMU Professional II 3/5 LoRa	MID B+D certification
P21A000LE	EMU Professional II 3/5 LoRa ext. Ant.	MID B+D certification
P21A030M	EMU Professional II 3/5 M-Bus LP	MID B+D, PTB-A 20.1 and PTB-A 50.7 certification
P21A030T	EMU Professional II 3/5 TCP/IP LP	MID B+D, PTB-A 20.1 and PTB-A 50.7 certification

Measurement Process

The EMU Professional II measures current and voltage as follows:

The EMU Professional II measures current and voltage each for 1 second after which the next measurement starts. During this second the following procedure happens:

- The EMU Professional II records 8192 measurement points for current I and voltage U each. These measurement points have a resolution of 32bit.
- All measurement values for both the current I and voltage U are squared, added up and divided by the number of measurement points (8192) at the end of the second. After this second the EMU Professional II calculates the square root of this value to get the RMS value for both current and voltage:

$$\sqrt{\frac{U_1^2 + U_2^2 + \dots + U_{8192}^2}{8192}} = U_{eff}$$

$$\sqrt{\frac{I_1^2 + I_2^2 + \dots + I_{8192}^2}{8192}} = I_{eff}$$

The power factor $\lambda(\cos\varphi)$ is calculated with:

$$\lambda = \frac{\int U \cdot I dt}{S} = \frac{\int U \cdot I dt}{U_{eff} \cdot I_{eff}}$$

And the active power :

$$P = \lambda \cdot S$$

The calculated integral of current and voltage, as well as power ensures the coverage of non-sine currents up to the 7th harmonic.

Protection against unauthorized alteration of settings

An anti-tamper seal can be affixed to the EMU Professional II to ensure the integrity of the settings. Furthermore an adhesive seal label makes any opening of the meter obvious.



Note: The LP version of the EMU Professional II is secured by an adhesive seal label on both sides of the meter.



Abbildung 3.1: Picture similar

Firmware Versions

The EMU Professional II has two firmware versions.

- The device FW-Version: Device firmware version and checksum can be found in the settings menu “SW Version”.
- The certified MID FW-Version: MID firmware version and checksum can be found in the settings menu “SW Version” by pressing the “Arrow down” Button for more than 2 seconds.

Operation Concept

The following explains the control elements of the EMU Professional II energy meter.

Buttons



Abbildung 3.2: Picture similar

The operation of the meter is done via two touch buttons and the service button (SRVC):

- “Arrow right” (Button 1)
 - Switch to the next main menu page with a short press (<2s) of the button.
 - Switch to the previous main menu page with a long press (>2s) of the button (Device FW 1.3.0 and newer).
- “Arrow down” (Button 2)
 - A short press (<2s) lets you switch between sub menu pages of a main menu item.
 - A longer press (>2s) lets you use the special functions for that sub menu item.
- “Service Button” (3)
 - The service button is set deep within the meter housing and must be operated with a thin nonconductive screwdriver or similar.
 - A short press (<2s) activates the edit mode of the settings.
 - A second short press (<2s) cancels the editing mode and exits without saving any changes.
 - A longer press (>2s) lets you save adjustments to the settings.

Anti-tamper Seal (4): The service button (SRVC) is covered by a cover cap after installation. An anti-tamper sealing of this cover secures your device against manipulation of the settings from third parties.

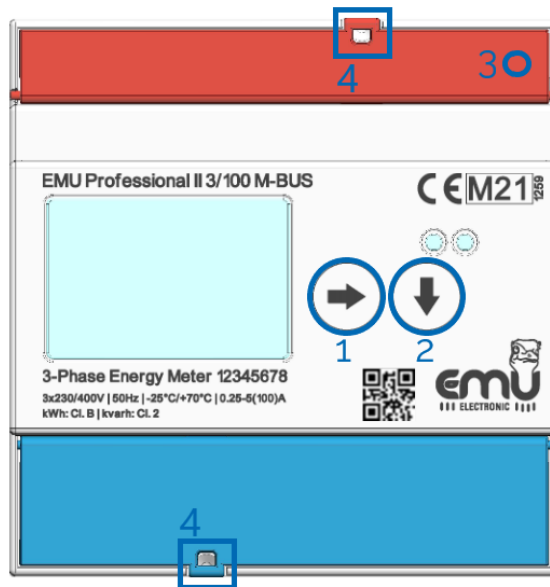
The current and voltage supply connectors can be similarly secured.

Overview Front EMU Professional II

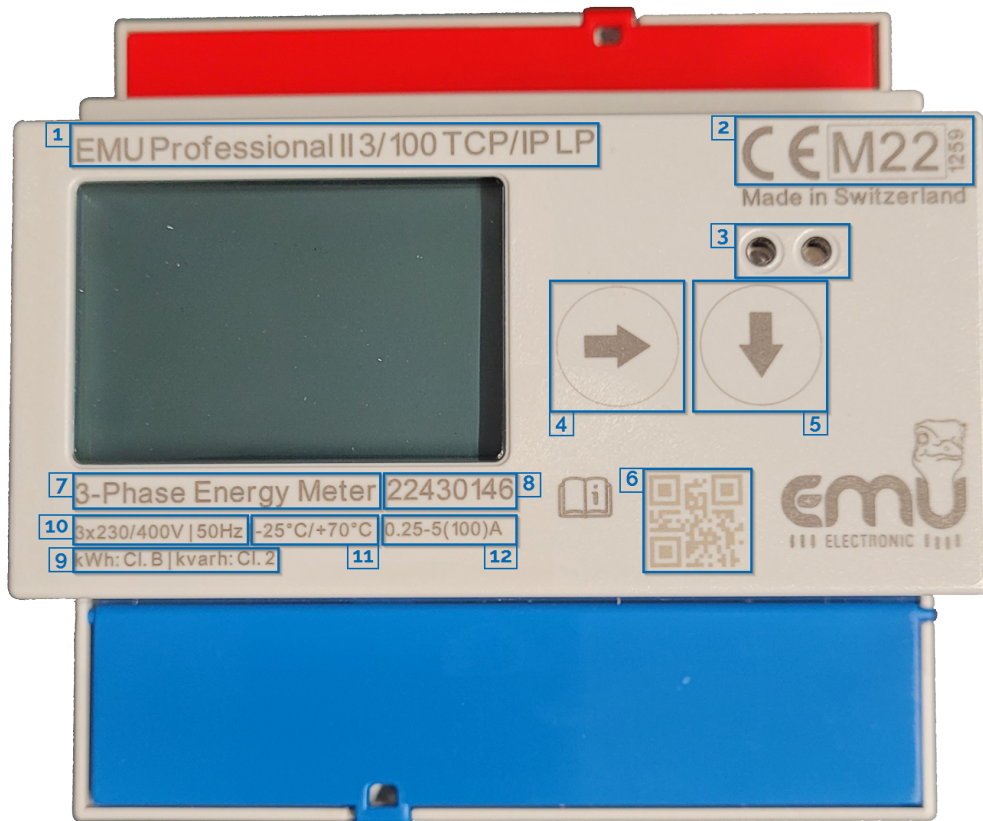

Picture similar

The front panel of the EMU Professional II shows the following primary features.

1. Type Description
2. Active Energy Certification
3. D0 Interface
4. Operating Key 'Arrow right'
5. Operating Key 'Arrow down'
6. QR Code with the serial number
7. Number of Phases, Number of Conductors
8. Serial number
9. Class identification
10. Reference Voltage, Reference Frequency
11. Operating temperature
12. Current range

The front panel also shows the following secondary element:

- The company logo.

Overview Laserprint Right

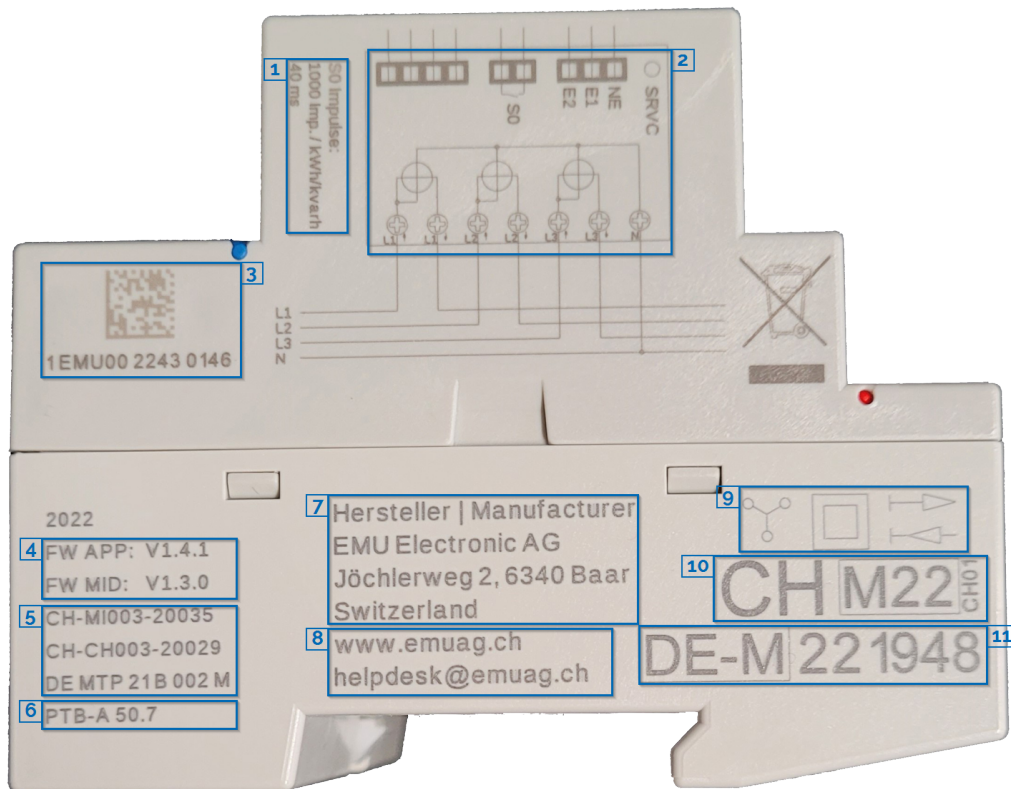

Picture similar

The following information is printed on the right side:

1. S0 Meter Constant
2. Connection Diagram
3. Identification number for measuring devices applying for all manufacturers
4. Firmware- and Software-Version
5. Type Test Certificate (MID, METAS, PTB)
6. PTB-A Certificate (only on the LP version)
7. Manufacturer name with address
8. Website and email for more information. Addresses may differ for OEM customers. Manufacturer e-mail: helpdesk@emuag.ch, Manufacturer website: www.emuag.ch
9. Connection Diagram, Insulation according to protection rating and Meter class
10. Reactive Energy Certificate
11. Load Profile Certificate according to PTB-A 50.7 (only on the LP version)

Overview Display

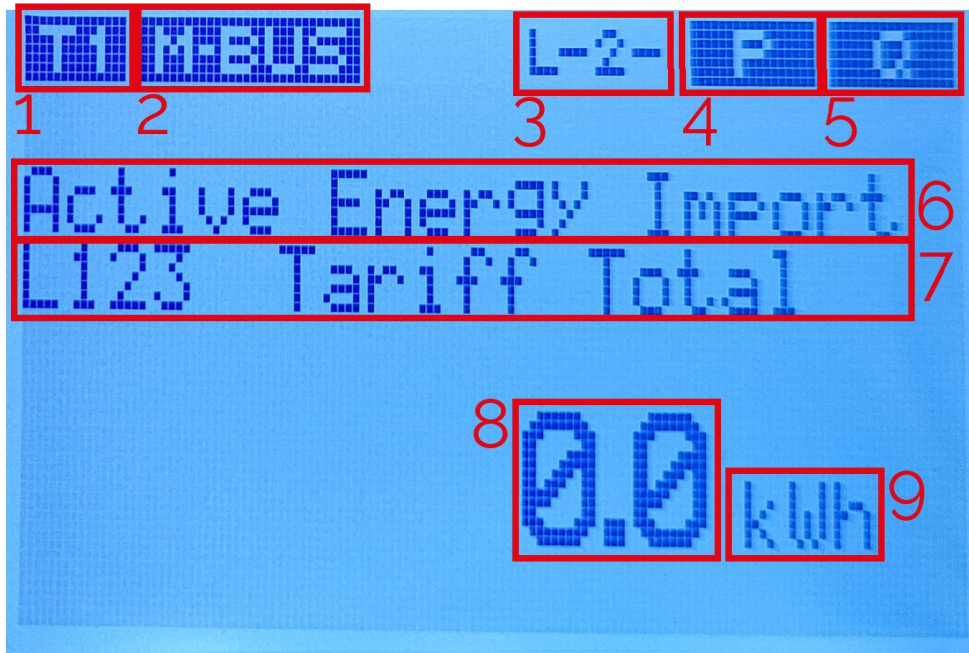

Picture similar

1. Current Tariff
2. Active Communication Interface (Model dependent)
3. Phase Sequence
4. 4 Quadrant display with 5.
 - “<<P” : Export Active Energy
 - “P>>” : Import Active Energy
5. 4 Quadrant display with 4.
 - “<<Q” : Export Reactive Energy (Inductive)
 - “Q>>” : Import Reactive Energy (Capacitive)
6. Measurement / Menu item
7. Sub Menu Item
8. Current Measurement Value
9. Unit of Current Measurement Value

The following table shows and describes all symbols that can show on the display.

Symbol	Description
T1	The currently set tariff. The number indicates which tariff.
MODBUS	The interface of the meter is Modbus.
ETH	The interface of the meter is TCP/IP.
M-BUS	The interface of the meter is M-Bus.
LoRa	The interface of the meter is LoRa.
L123	All phases are connected. If one or more of the numbers are replaced by a “-” then the corresponding phase is not connected.
P→	The meter is currently measuring active energy import.
←P	The meter is currently measuring active energy export.
Q→	The meter is currently measuring reactive energy import (Capacitive).
←Q	The meter is currently measuring reactive energy export (Inductive).
OF	One or more energy registers have detected an overflow.
MEM	The internal memory of the meter has a defect. Please create a ticket at https://www.emuag.ch/en/support-2/support-form/ .

The following symbols only appear on the LP version.

Symbol	Description
TNW	The date and time of the meter are invalid. Please synchronize the date and time with the current date and time.
TNS	Date and time on the meter is not synchronized correctly.
NTF	Only applies to the EMU Professional II with the TCP/IP interface. The meter couldn't synchronize its date and time for at least one hour.
FTB NV	The meter is in an invalid calibration state. All further measurements by the meter must not be used for billing purposes.

Compatible Devices

Interfaces:

- M-Bus
- TCP/IP, Modbus TCP
- Modbus RTU
- LoRa

The EMU Professional II is compatible with the EMU M-Bus Center and our energy management software Joulio-Web (ISO 50001 certified). You profit from templates for the meter register configuration of the EMU Professional II as well as an easy incorporation of your EMU M-Bus Center and meters into Joulio-Web.

Installation

The EMU Professional II is not dependent on location or position. The meter is designed to fit on 35mm DIN-rails (EN 50022) or to be installed with a front installation frame. To remove the meter from a DIN-rail just pull the spring loaded bolt on the underside. The cabling for the converter counter should be held as short as possible.

In case of significant measurement errors after Installation, please consider the following points:

- The use of Rogowski-coils as current transformers for the converter counter is discouraged because of the multiple current / voltage transformation and external amplifiers. Each transformation adds a multiplicative error on the measurement.
- Internal Consumption
 - Each meter has internal energy consumption. A main meter will measure more energy consumed than the sum of all of its sub meters. The EMU Professional II uses up to 2W per phase depending on the model. In a year this adds up to an average of 36kWh/year internal consumption per meter, up to a maximum of 52.5kWh/year per meter.
- Starting Current
 - The EMU Professional II 3/5 starts counting at a phase-current of 1mA, the EMU Professional II 3/100 starts counting at a phase-current of 20mA.
- Precision
 - The EMU Professional II features accuracy class B (active energy) and class 2 (reactive energy) according to EN50470. Thus a measurement error of 1% (active energy) and 2% (reactive energy) may occur per meter. The total energy measured on a possible main meter will have this error only once, while the total energy measured by several sub meters will have this error added several times.
 - Example: A main meter has 20 sub meters. Each sub meter measures with an error of -0.2% (less energy measured than really used). The main meter measures with an error of +0.2% (more energy measured than really used). The total energy measurement error of the added sub meters will be $100\text{kWh(used)} * 20(\text{sub meters}) * -0.2\%(\text{error}) = -4\text{kWh}$, while the total energy measurement error of the main meter will be $100\text{kWh(used)} * 1(\text{main meter}) * +0.2\% = 0.2\text{kWh}$. The total energy difference between main and sub meters is therefore 4.2kWh or 4.2% of the total used energy of 100kWh.
- Energy Direction (converter counter)
 - If all currents are expected to be positive (import measurement) but one or several currents are negative, please check the correct installation of your current-transformers as they have been wrongfully installed.
- Transformer Ratio (converter counter)
 - The transformer ratios on the meter must be the same as the ones of the installed current / voltage transformers.
- Correct Phase-assignment
 - Current L1 and voltage L1 must be connected to the same measurement system. See Connection Diagram Converter Counter.

The meter weighs about 350g.

To ensure most efficient installation and service of the EMU Professional II meters we recommend using indirect metering such as EMU Professional II 3/5 meters for installations where a quick and inexpensive shut down of the installation is not possible.



Attention: The installation of the meter must be carried out by qualified and trained personnel. Current transformers must not operate open loop as high voltages can occur. These voltages can lead to substantial personal and/or property damage.



DANGER: Make sure that all connected wires are voltage free before you install / change or check the meter. Touching any live elements is dangerous to life!



DANGER: *The EMU Professional II 3/5 has voltage on the current path! Make sure that the voltage connections are voltage free before you install the current transformer. Touching any live elements is dangerous to life!*



Attention: *According to DIN VDE 0100-557, Punkt 5.3.1, the secondary winding of current transformers must not be grounded in low-voltage-installations!*



Attention: *Only use the intended screw and spring clamps to connect your meter. It is recommended to use end sleeves.*



Attention: *Nonobservance of mounting and installation instructions may lead to damage or destruction of this meter. Please keep to the instructions.*

Technical Data

For the technical data of the EMU Professional II please consult the document "Datasheet EMU Professional II" Doc.Ref: 1441.

Commissioning / Check-up

The following points should be checked before operation:

- Phase rotation
- Current per phase, Negative energy direction
- Sequence of phase (L1 L2 L3)
- Current Transformer ratio
- Voltage Transformer ratio
- Terminal tightening torque
- Read-out interface: Correct address

The EMU Professional II is to be used exclusively to measure electrical energy and must not be operated outside the specified technical limits.

Settings ex Factory

S0 Output : Active Energy Import (Pin 6 + 7)

Current transformer meter: 10 Impulse / kWh

Direct meter: 1000 Impulse / kWh

Measurements

For the physical measurements please refer to the document "Massbild Dimensional Drawing EMU Professional II" Doc.Ref: 1420.

Connection Diagram Direct Meter

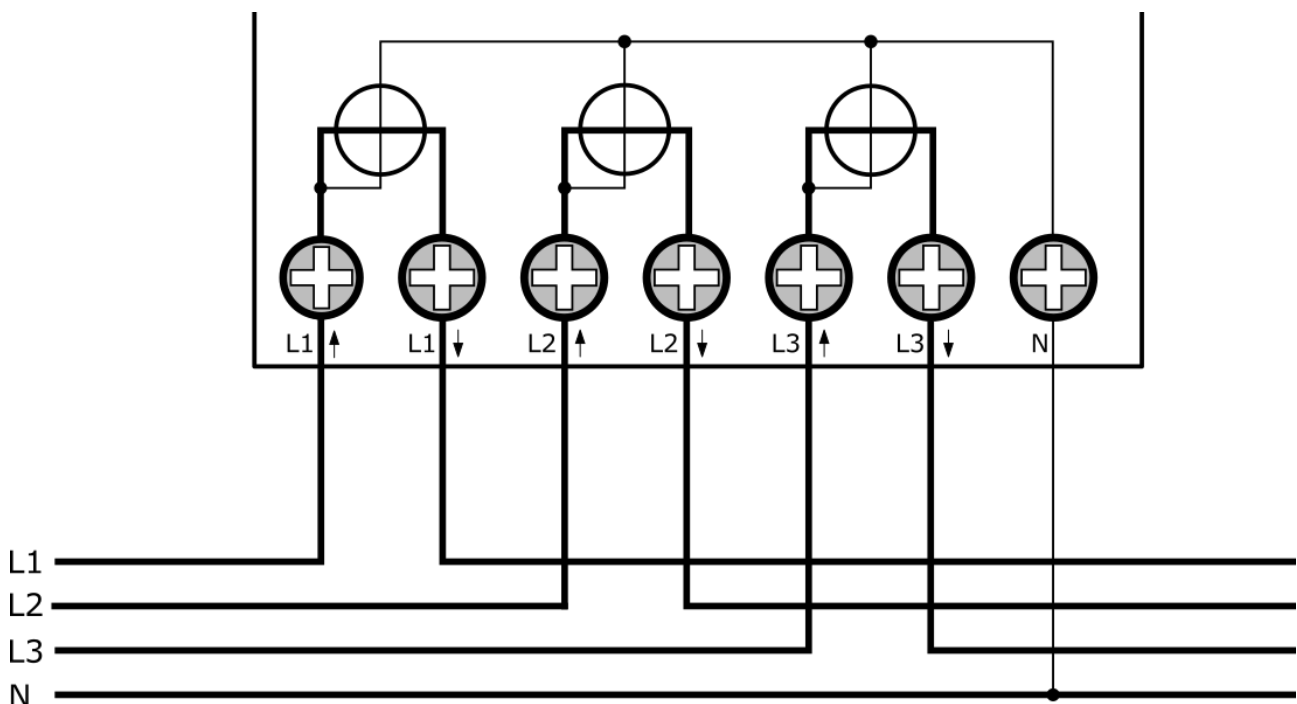

The direct meter taps the voltage of the phases internally. Connect the neutral conductor to the "N" connector.

Pay special heed to the arrows on the connection clamps of the meter. "Lx↑" is **always** on the grid side, "Lx↓" **always** on the installation side.



Note: Connect the meter according to the instructions even if the meter only ever measures exported energy! The EMU Professional II measures import as well as export correctly.

The following table shows the most important characteristics of the direct connections:

I_{st}	I_{min}	I_{tr}	I_{ref}	I_{max}
0.02A	0.15A	0.5A	5A	100A



DANGER: Make sure that all connected wires are voltage free before you check or change any connections. Touching any live elements is dangerous to life!

Connection Diagram Converter Counter

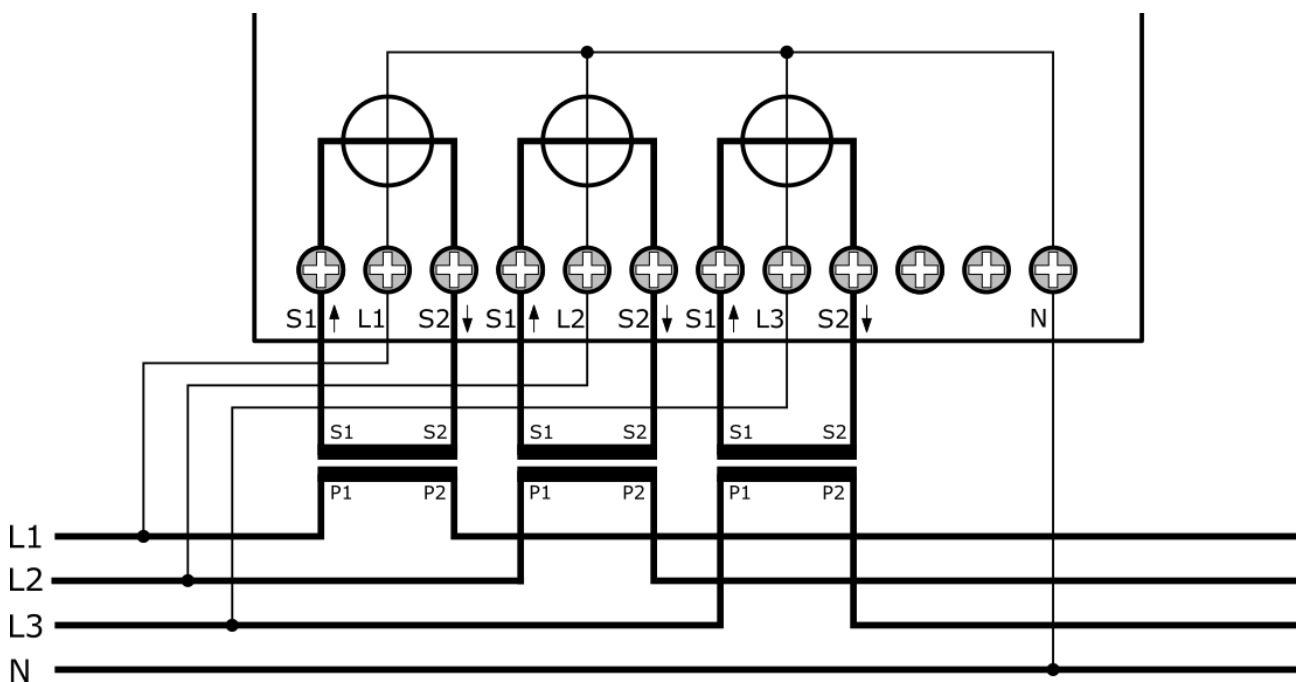

The EMU Professional II converter counter needs an external voltage tap. Connect this voltage tap to the corresponding “Lx” connector. Connect the neutral conductor to the “N” connector.

Pay special heed to the arrows on the connection clamps of the meter. “S1↑” is **always** on the grid side, “S2↓” **always** on the installation side.



Note: Connect the meter according to the instructions even if the meter only ever measures exported energy! The EMU Professional II measures import as well as export correctly.



Attention: Due to the voltage on the current path on the EMU Professional II 3/5 any connected current transformers must not be grounded!



Attention: The two connector clamps between “S2↓” of phase 3 and the neutral conductor are for future functions. Do not connect anything to these clamps. Incorrect connection of these two clamps can lead to substantial damage to the meter.

The following table shows the most important characteristics of the converter connections:

	Current /5A	Current /1A
I_{st}	0.005A	0.001A
I_{min}	0.05A	0.01A
I_{tr}	0.25A	0.05A
I_{ref}	5A	1A
I_{max}	6A	1.2A



DANGER: Make sure that all connected wires are voltage free before you check or change any connections. Touching any live elements is dangerous to life!

Tightening Torque

Net	Direct connections up to 35mm ² strand	Converter connections up to 6mm ² strand
Supply L1/L2/L3	2-3Nm	0.8 - 1Nm
Supply N	2-3Nm	0.8 - 1Nm



Note: It is recommended to use end sleeves.



Note: The signal outputs have spring-cage clamps.

Spring-Cage Clamps Wire Diameter

Connection	Diameter	Stripping
S0 pulse output	1.5mm ² strand	12mm
Tariff control	1.5mm ² strand	12mm
M-Bus / Modbus	1.5mm ² strand	12mm



Note: For connections above 65 A, make sure to install a cable with enough diameter.

Operation

This chapter explains the navigation through the different menu and sub menu pages.

Main Menu Pages

When you connect the EMU Professional II to a supply voltage for the first time, a “test display” is shown. After 2 seconds the main menu page “Active Energy Import” is displayed. Every press of the “Arrow Right” button switches to the next main menu page in a closed loop as follows:

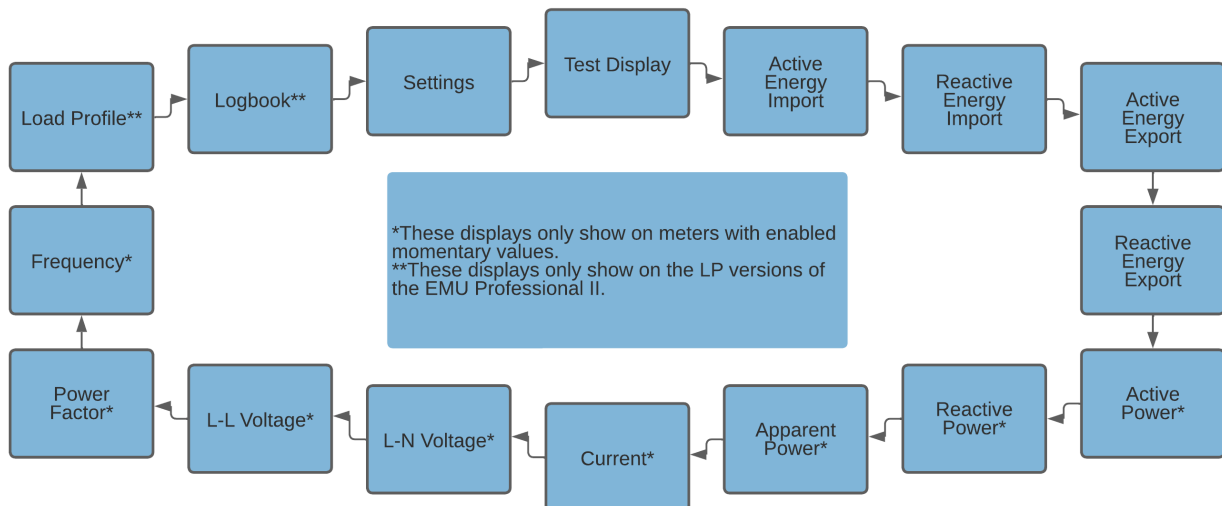

A longer press (>2s) of the “Arrow right” button lets you go back to the previous page. (FW version 1.3.0 and newer)



Note: Depending on your meter configuration one or more of these main menu pages do not show up. Please consult the picture above for more information.

Sub Menu Pages

A list of all sub menu pages follows.

Energy

The main menu pages “Active Energy Import / Export” and “Reactive Energy Import / Export” display by default the total Import / Export of the corresponding energy. By default the following diagram applies for their sub menu pages:

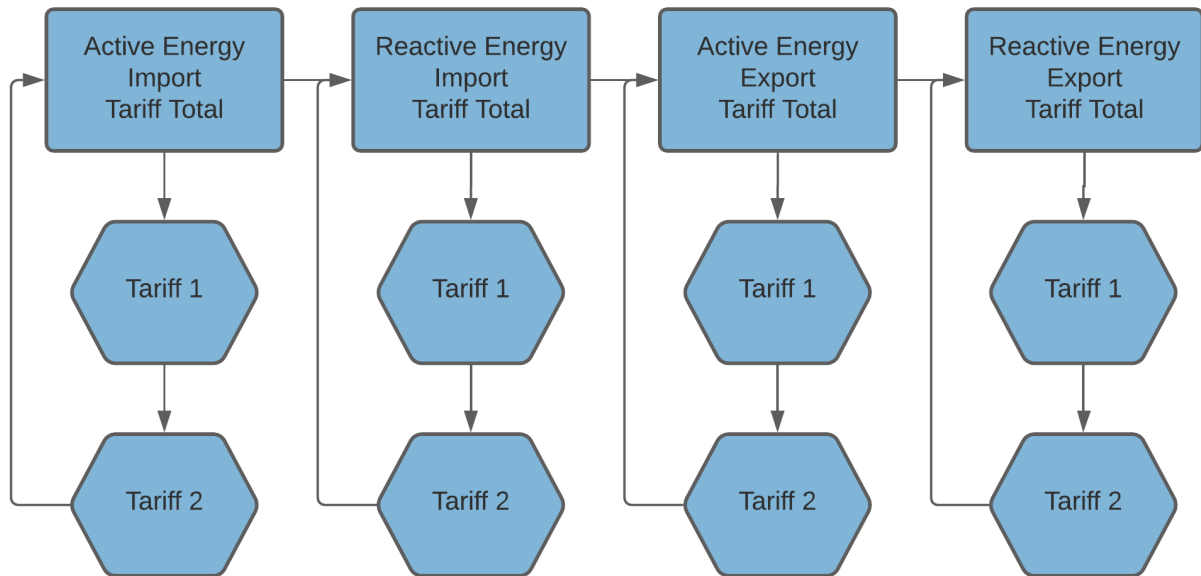

Note: It is possible to adjust these displays. Please consult the chapter Settings for the Display.

The EMU Professional II features an auto-range function to guarantee a energy value display as precise as possible. Once the display overflows, an “OF” flag is set on the display. If this flag is set, the display reading that overflowed starts again from zero. Keep in mind that the registers in the background overflow much later (ca. 18 Bn. GWh) than the display (99 Mio. MWh). Even in case of a display overflow, the correct measurements can still be read out if an optional interface (M-Bus, Modbus, TCP, LoRa) is available. The display shows the energy readings as follows:

Meter count [Wh]	Divider (prescaler)	Divider (dec. digit)	Display Range Start	Display Range End	Unit	Change
1	100	10	0.0	0.0	kWh	
10	100	10	0.0	0.0	kWh	
100	100	10	0.1	0.9	kWh	
1'000	100	10	1.0	9.9	kWh	
10'000	100	10	10.0	99.9	kWh	
100'000	100	10	100.0	999.9	kWh	
1 * 10 ⁶	100	10	1000.0	9999.9	kWh	
10 * 10 ⁶	100	10	10000.0	99999.9	kWh	
100 * 10 ⁶	100	10	100000.0	999999.9	kWh	
1 * 10 ⁹	100	10	1000000.0	9999999.9	kWh	
10 * 10 ⁹	1'000	1'000	10000.000	99999.999	MWh	3 decimal places; Unit
100 * 10 ⁹	10'000	100	100000.00	999999.99	MWh	2 decimal places
1 * 10 ¹²	100'000	10	1000000.0	9999999.9	MWh	1 decimal place

Meter count [Wh] Range	Divider (prescaler)	Divider (dec. digit)	Display Range Start	Display Range End	Unit	Change
$10 * 10^{12}$	1'000'000	1	10000000	99999999	MWh	no decimal places
$100 * 10^{12}$			Overflow display	Display Overflow	MWh	Display Overflow, Restart at 0
$1 * 10^{15}$			Overflow display	Display Overflow	MWh	
$10 * 10^{15}$			Overflow display	Display Overflow	MWh	
$100 * 10^{15}$			Overflow display	Display Overflow	MWh	
$1 * 10^{18}$			Overflow display	Display Overflow	MWh	
$10 * 10^{18}$			Overflow counter	Overflow counter	MWh	Overflow counter

Maximal energy register value: 18'446'744'073'709'600'000 Wh = 18'446.7 PWh

Power and Current

The main menu pages of “Active / Reactive / Apparent power” display the total current power import. Pressing the “Arrow Down” button lets you change the display to the power import on individual phases.

The main menu pages “Current” displays the total current for all 3 phases. Pressing the “Arrow Down” button lets you change the display to the current of individual phases.

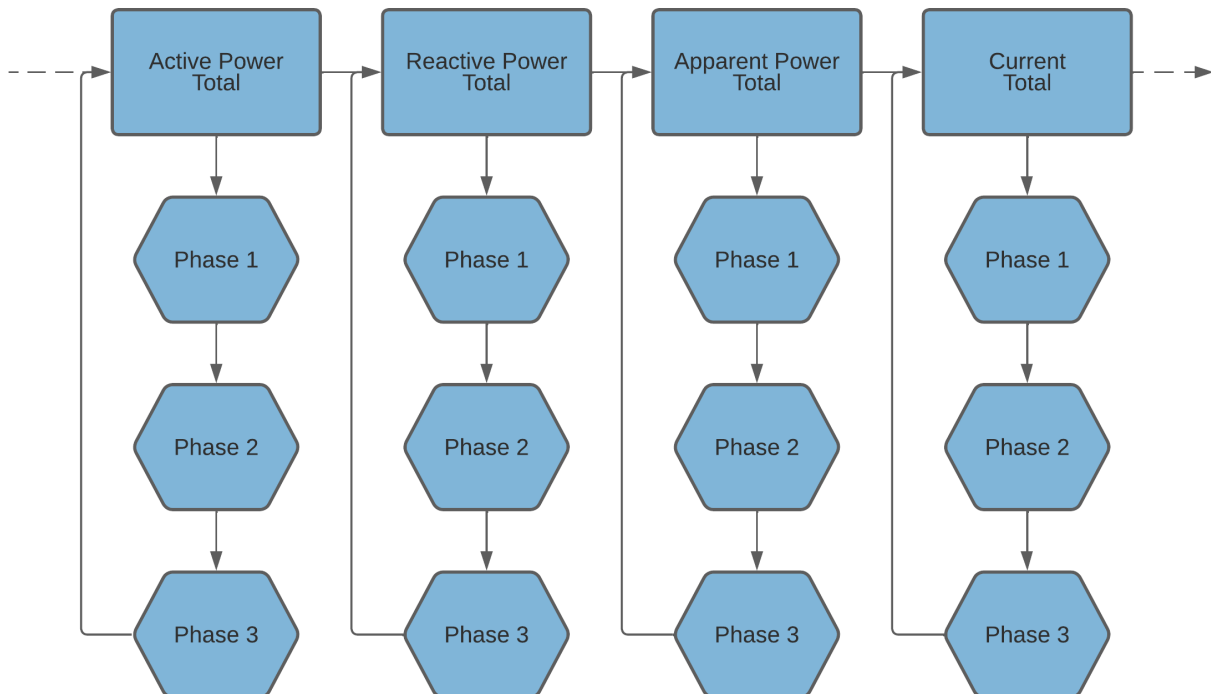

The 4-Quadrant figure shows the relation between active and reactive energy. If active power is negative the current is negative as well. The figure also shows the corresponding energy directions read out on the LCD ($P >>$, $Q >>$, etc.).

- Quadrant I
 - Active power positive, Active Energy Import Register increases
 - Reactive power positive, Reactive Energy Import Register increases
- Quadrant II
 - Active power negative, Active Energy Export Register increases
 - Reactive power positive, Reactive Energy Import Register increases
- Quadrant III
 - Active power negative, Active Energy Export Register increases
 - Reactive power negative, Reactive Energy Export Register increases
- Quadrant IV
 - Active power positive, Active Energy Import Register increases
 - Reactive power negative, Reactive Energy Export Register increases

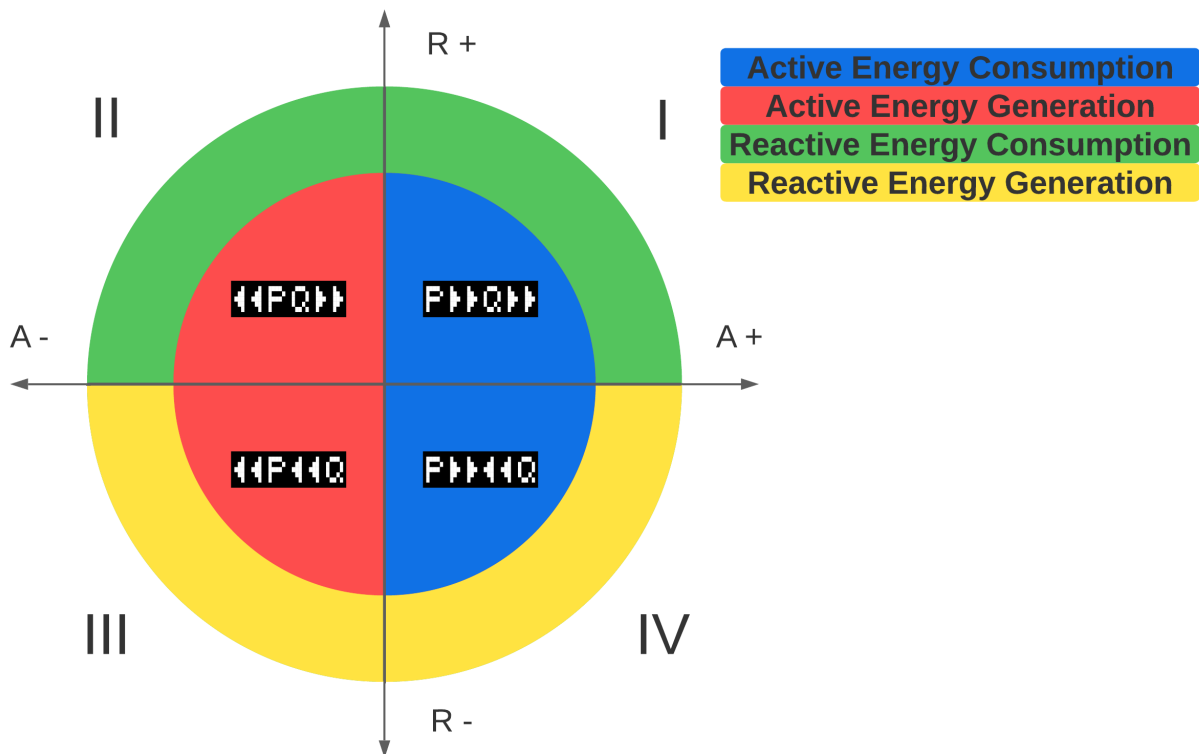

Voltage, Power Factor and Frequency

These menu pages show the momentary values for voltage, power factor and frequency. The values are updated every second.

If the setting “Min/Max Values” is activated you can browse the maximum and minimum values of the corresponding measurements. The time and date when those values were recorded are stored as well.

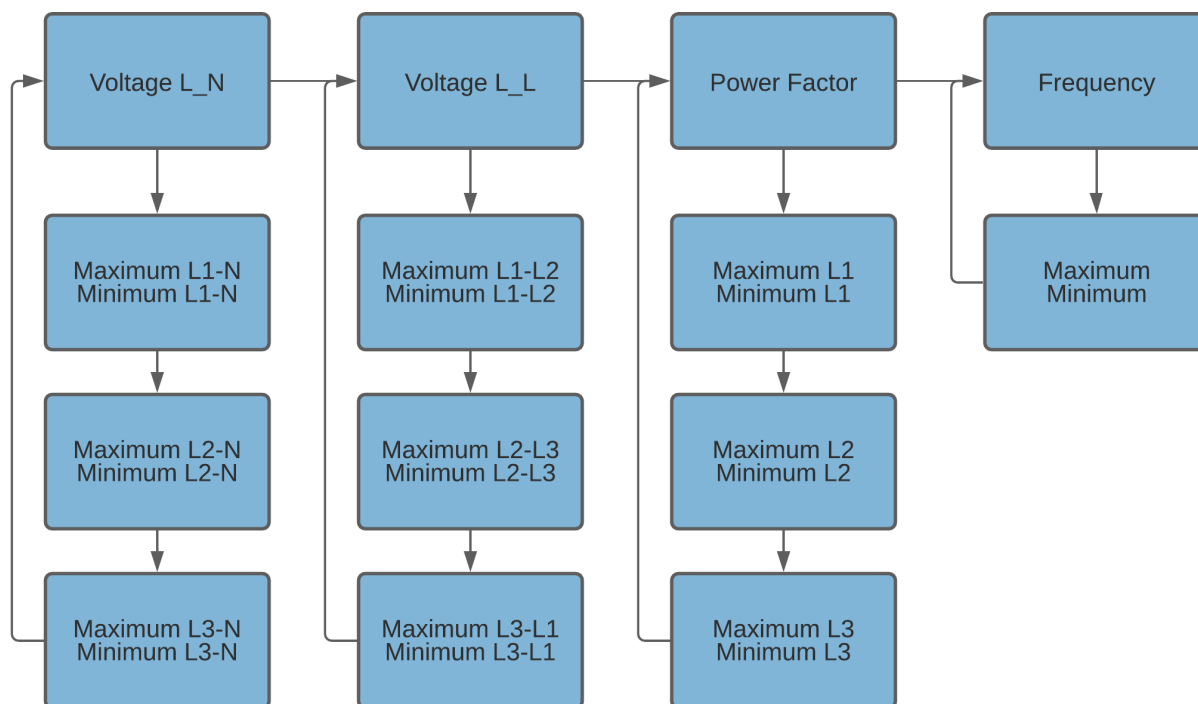

Load Profile and Logbook

A short press (<1s) on the “Arrow Down” button lets you browse the saved load profiles and logbook entries. The entries always start with the latest entry.

A longer press (>2s) of the “Arrow Down” button lets you change between import and export for the load profiles and between the adjustment and the meter readings at the time of the adjustment for the logbook page.

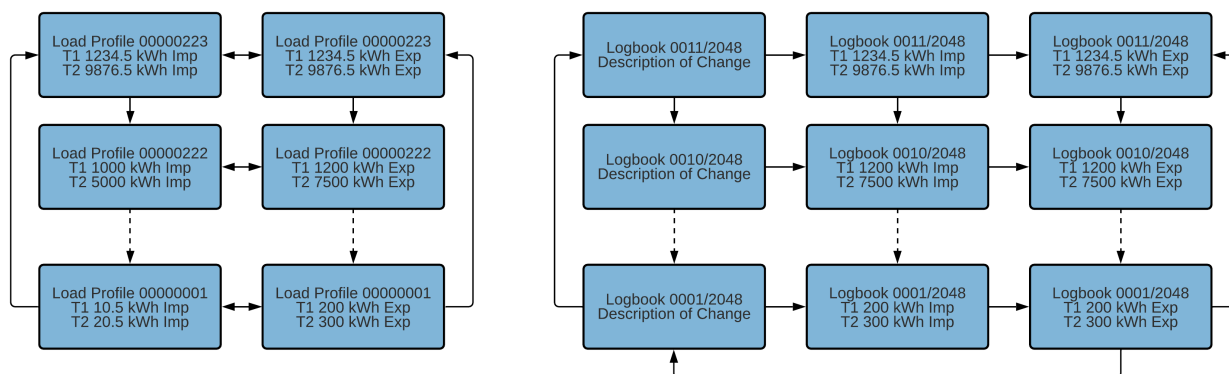



Note: MID firmware version and checksum are stored in the settings under “SW Version” and accessible by pressing the “Arrow Down” button for more than 2 seconds while on that menu page.

Configuration Settings

Language | Sprache

Switch between the languages “German” (default) and “English”.

- “Arrow right” to settings (“Einstellungen” in German)
- “Arrow down” to Language (“Sprache” in German)
- Press “SRVC” button (<2 seconds)
- “Arrow down” changes between “German” and “English”
- Save: Press “SRVC” button (>2 seconds) until the LCD flashes

Tariff Change

A newly set tariff activates immediately. Tariff 1 is set ex factory. The tariff inputs are internally electrically isolated through opto-couplers.

The tariff-signal is a 230VAC voltage between NE (Clamp 11) and E2 (Clamp 9) / E1(Clamp 10). Tariffs can be set according to the following truth table. “0” means 0VAC and “1” means 230VAC.

E2 (Clamp 9)	E1 (Clamp 10)	Tariff
0	0	1
0	1	2
1	0	3
1	1	4



Note: A change of tariff on the LP version of the EMU Professional II is not set until the start of the next load profile interval. A tariff set at the beginning of an interval is set for at least the duration of this interval.

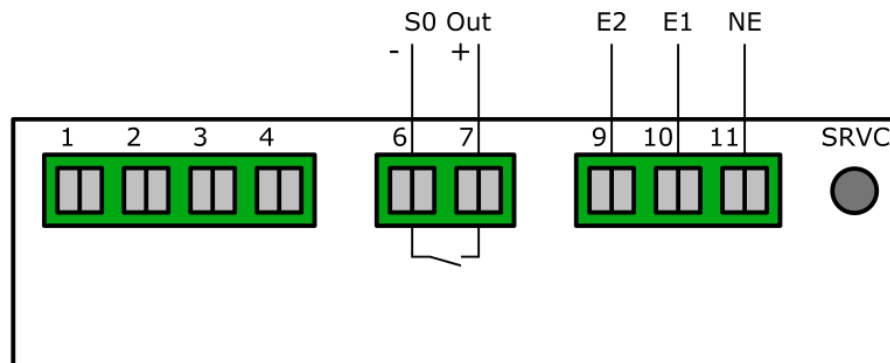

Set Number of Tariffs

Set the number of tariffs in the settings. Choose between a two-rate tariff (2) and a four tariff system (4).

- “Arrow right” to settings
- “Arrow down” to Number of Tariffs
- Press “SRVC” button (<2 seconds)
- “Arrow down” changes between 2 and 4 tariff operation
- Save: Press “SRVC” button (>2 seconds) until the LCD flashes



Note: All pictures in this documentation show only 2 tariffs. The display navigation functions the same with 4 tariffs as with 2 tariffs.



Note: The LP version of the EMU Professional II is fixed to 2 tariff operation. This cannot be changed.

Real Time Clock (RTC)

The real time clock of the EMU Professional II can be set directly on the energy meter or over optional interfaces. These interfaces (TCP/IP, M-Bus, LoRa) allow for a connection to a time server which allows the meter to synchronize itself. The EMU Professional II has an internal clock with a possible daily deviation of ± 0.4 seconds.

The LP Version of the EMU Professional II has special notifications based on the RTC that can pop up on the display. For more information on the LP version of the EMU Professional II please consult the PTB-A 50.7 specific chapter at the end of this user manual.

Configuration on the Device

The real-time clock can be set directly on the EMU Professional II via the touch buttons. The internal RTC is buffered with a super-cap for at least 18 days while the power is out, leading to fewer RTC settings because of brownouts / blackouts.



Note: The meter must be powered for at least 2 hours beforehand to fully charge the super-cap.

- “Arrow right” to settings
- “Arrow down” to Real-time Clock
- Press “SRVC” button (<2 seconds)
- “Arrow right” chooses the digit, “Arrow down” increments the digit
- Save: Press “SRVC” button (>2 seconds) until the LCD flashes

Automatic Synchronization

Time synchronization on M-Bus meters happens through a defined command. The answer entails information about time and date. The meter synchronizes immediately and sends an acknowledge (ACK) back as acknowledgement.

Meters with the TCP/IP or LoRa Interface can synchronize themselves if an NTP time server is specified. For the first synchronization the meter sends time-requests every 1-2 minutes. After the first successful synchronization the request interval goes to once every hour.



Note: Projects with the obligatory load profile certification PTB-A 50.7: Only 2048 entries for a RTC synchronization (or transformer ratio adjustment, S0 ratio adjustment or S0 impulse duration adjustment) are possible before the meter falls into a non-valid state. Transformer ratio adjustments can only be done once every load profile interval (15 min).

Load Profile Interval

Set the load profile interval in the settings. Choose between an interval of 1min, 5min, 15min(default), 30min, 1h, 6h, 12h or 24h.

- “Arrow right” to settings
- “Arrow down” to Load Profile Interval
- Press “SRVC” button (<2 seconds)
- “Arrow down” changes the interval time
- Save: Press “SRVC” button (>2 seconds) until the LCD flashes



Note: This setting is only available on meters with load profile activated. TCP/IP and LoRa meters have load profile ex factory.



Note: Any LP version of the EMU Professional II has a fixed load profile interval of 15 minutes. This cannot be changed.

Configuration of Transformer Ratio

The transformer ratio can be set directly on the EMU Professional II via the touch buttons.

- “Arrow right” to settings
- “Arrow down” to CT / VT Ratio
- Press “SRVC” button (<2 seconds)
- “Arrow right” chooses the digit, “Arrow down” increments the digit
- Save: Press “SRVC” button (>2 seconds) until the LCD flashes

Change the current transformer ratio from 5A:5A up to 20'000A:5A in 5A-steps and 1A:1A up to 4'000A:1A in 1 A-steps.

Change the voltage transformer ratio from 100V:100V up to 36'000V:100V in 100V-steps.

Both primary and secondary current of the transformer must be set. A set ratio of 100:1 means that a primary current of 100A results in a secondary current of 1A on the meter.



Note: Ensure that this ratio matches your current / voltage transformer and area of application. Wrongfully installed transformers falsify energy measurement.



Note: Projects with the obligatory load profile certification PTB-A 50.7: Only 2048 entries for a transformer ratio adjustment (or RTC adjustment, S0 ratio adjustment or S0 impulse duration adjustment) are possible before the meter falls into a non-valid state. Transformer ratio adjustments can only be done once every load profile interval (15 min).

S0 Pulse Ratio

The pulse ratio can be set directly on the EMU Professional II via the touch buttons.

- “Arrow right” to settings
- “Arrow down” to Pulse Ratio
- Press “SRVC” button (<2 seconds)
- “Arrow right” choose between 1, 10, 100, 1000 and 10000 imp / kWh
- Save: Press “SRVC” button (>2 seconds) until the LCD flashes



Note: Projects with the obligatory load profile certification PTB-A 50.7: Only 2048 entries for a S0 ratio adjustment (or RTC adjustment, transformer ratio adjustment or S0 impulse duration adjustment) are possible before the meter falls into a non-valid state. S0 ratio adjustments can only be done once every load profile interval (15 min).

S0 Impulse Duration

The pulse duration can be set directly on the EMU Professional II via the touch buttons.

- “Arrow right” to settings
- “Arrow down” to impulse duration
- Press “SRVC” button (<2 seconds)
- “Arrow right” choose between 2ms, 10ms, 30ms, 40ms and 120ms
- Save: Press “SRVC” button (>2 seconds) until the LCD flashes



Note: Projects with the obligatory load profile certification PTB-A 50.7: Only 2048 entries for a S0 impulse duration adjustment (or RTC adjustment, transformer ratio adjustment or S0 ratio adjustment) are possible before the meter falls into a non-valid state. S0 impulse duration adjustments can only be done once every load profile interval (15 min).

Configuration of the Energy Display

Configure what is shown on the display. You may choose from the following settings.

Energy per Tariff:

- On: The EMU Professional II displays the imported / exported energy for each tariff on the main menu pages “Active Energy Import / Export” and “Reactive Energy Import / Export”.
- Off: The display only shows the total for all tariffs and the chosen setting for “Energy per Phase”.

Energy per Phase:

- On: The EMU Professional II displays the imported / exported energy for each phase on the main menu pages “Active Energy Import / Export” and “Reactive Energy Import / Export”.
- Off: The display only shows the total for all tariffs and the chosen setting for “Energy per Tariff”.

Overview

Depending on which settings for the energy import / export display are activated, the sub menu pages of the energy displays are as follows:

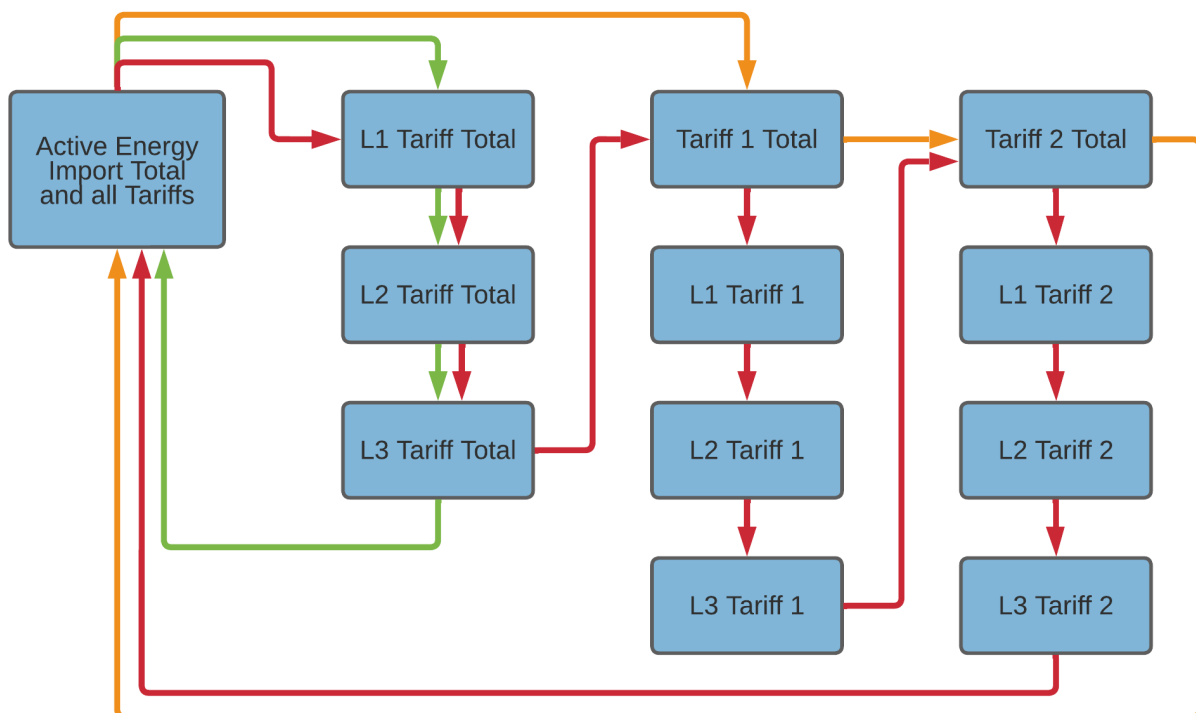

Legend:

- Green: Only the option “Energy per Phase” is on
- Orange: Only the option “Energy per Tariff” is on.
- Red: Both options are on.

Configuration Interfaces

The EMU Professional II can be equipped with several interfaces. There is only one interface possible per meter.

Interfaces

The EMU Professional II may optionally be equipped with one of the following interfaces:

- M-Bus
- Modbus RTU
- TCP/IP mit Modbus TCP/IP
- LoRa



Note: An EMU Professional II only ever possesses one of these interfaces.

You can configure your EMU Professional II directly on the meter via the touch buttons.

M-Bus

The M-Bus interface is implemented according to EN 13757-2,-3 (formerly EN1434-3). Therefore the EMU Professional II M-Bus can communicate with all M-Bus capable devices. The M-Bus interface is integrated into the meter and protected from contamination and manipulation. The interface is located at the back of the meter on pin 1[3] (+) and pin 2[4] (-). Please consult the document "Manual M-Bus EMU Professional II" Doc.Ref: 1480 for further information on the M-Bus interface.

Settings ex Factory

Setting	Value
Secondary Address	Serial number of the device
Primary Address	0
Baud rate	2400

Connection Diagram M-Bus

The EMU Professional II M-Bus possesses two internally connected M-Bus clamps. This facilitates an easier serial connection of multiple M-Bus devices while installing.



Note: The M-Bus interface is the same for both the EMU Professional II 3/100 M-Bus and the EMU Professional II 3/5 M-Bus.

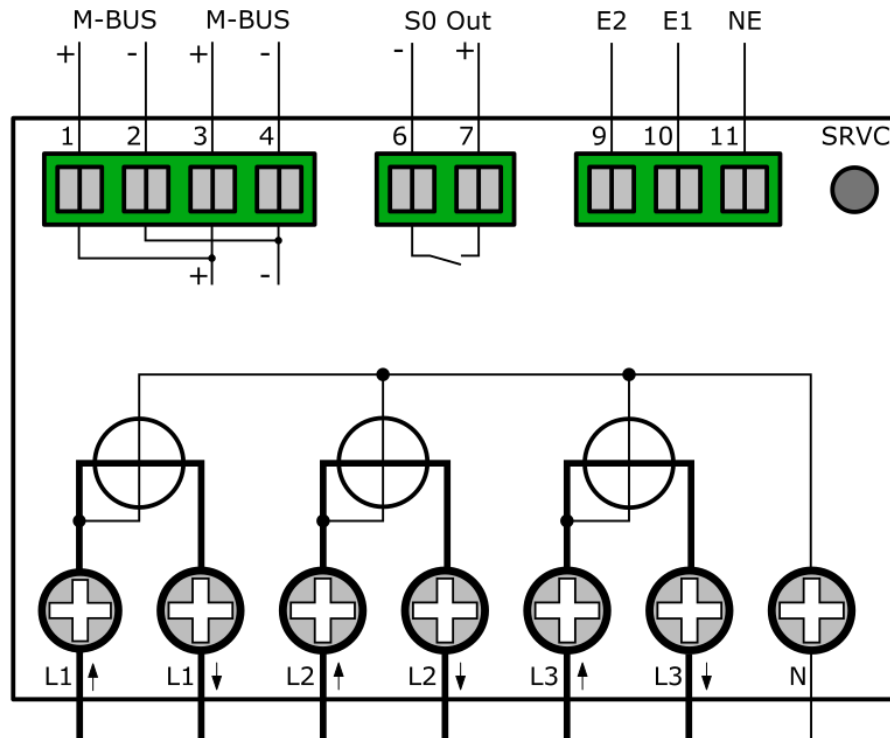

Configuration of the Primary Address on the Device

- “Arrow right” to settings
- “Arrow down” to M-Bus Pri. Address
- Press “SRVC” button (<2 seconds)
- “Arrow right” chooses the digit, “Arrow down” increments the digit
- Save: Press “SRVC” button (>2 seconds) until the LCD flashes

Configuration of the Secondary Address on the Device

- “Arrow right” to settings
- “Arrow down” to M-Bus Sec. Address
- Press “SRVC” button (<2 seconds)
- “Arrow right” chooses the digit, “Arrow down” increments the digit
- Save: Press “SRVC” button (>2 seconds) until the LCD flashes

Configuration of the Baud Rate on the Device

- “Arrow right” to settings
- “Arrow down” to M-Bus Baud Rate
- Press “SRVC” button (<2 seconds)
- “Arrow right” chooses between 300, 600, 1’200, 2’400 (default), 4’800 and 9’600 Baud
- Save: Press “SRVC” button (>2 seconds) until the LCD flashes

Configuration via MB-Connect

The EMU Professional II M-Bus can also be configured over M-Bus with our own software MB-Connect.

For further information on the M-Bus Interface, as well as the software MB-Connect, please refer to the document "Manual M-Bus EMU Professional II" Doc.Ref: 1480.

S0 Pulse Output

The S0 Pulse Output is implemented according to Norm EN 62053-31 (DIN 83864). Every EMU Professional II possesses a S0 Pulse Output and is therefore capable to communicate with any devices that can receive and interpret such pulses. The Interface is on the backside on pin 6 and pin 7. The internal switch is a highly robust Opto Power MOSFET 5–60VAC or VDC.

The S0 Pulse Output is potential free.



Note: Please take the polarity into account.

Settings ex Factory

S0 Output	Active Energy Import (Pin 6 + 7)
Converter Counter	10 Pulses per kWh / Kvarh @ 120ms Pulse Duration
Direct Meter	1000 Pulses per kWh / Kvarh @ 40ms Pulse Duration

Connection Diagram S0 Pulse Output



Note: The S0 interface is the same for both the EMU Professional II 3/100 and the EMU Professional II 3/5.

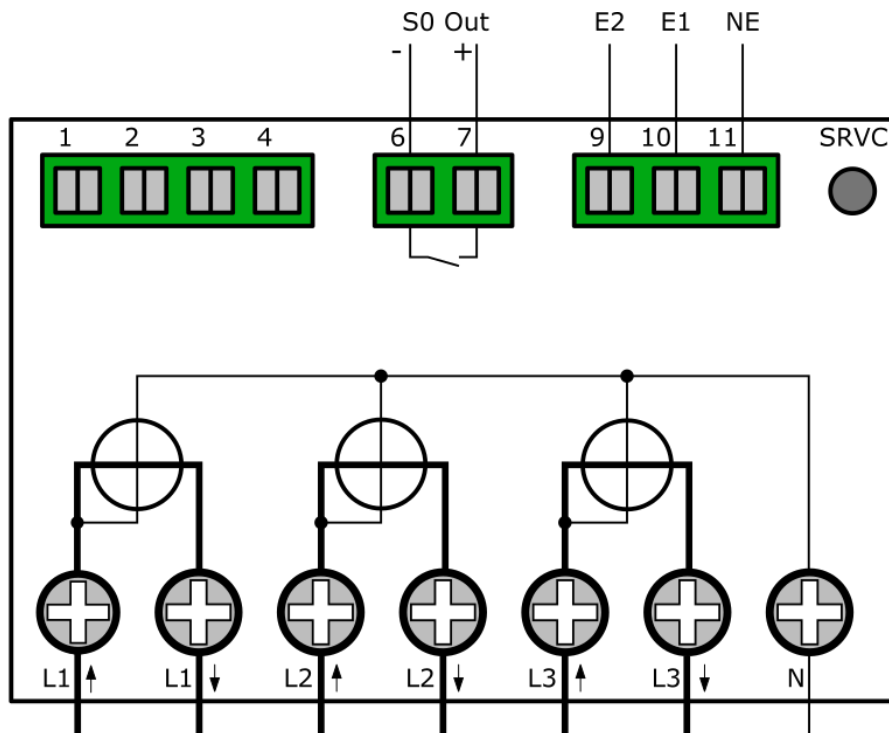

Configuration of Read-Out Type

- “Arrow right” to settings
- “Arrow down” to S0 Impulse Type
- Press “SRVC” button (<2 seconds)
- “Arrow right” chooses between:
 - Active Energy Diff: All active Energy, either import or export, is output without differentiating.
 - Reactive Energy Diff: All reactive Energy, either import or export, is output without differentiating.
 - Active Energy Import: Only active energy import is output. All other energies are ignored.
 - Reactive Energy Import: Only reactive energy import is output. All other energies are ignored.
 - Active Energy Export: Only active energy export is output. All other energies are ignored.
 - Reactive Energy Export: Only reactive energy export is output. All other energies are ignored.
- Save: Press “SRVC” button (>2 seconds) until the LCD flashes

Configuration of the Pulse Rate

- “Arrow right” to settings
- “Arrow down” to S0 Impulse Ratio
- Press “SRVC” button (<2 seconds)
- “Arrow right” chooses between 1, 10, 100, 1000 and 10'000 pulses per kWh / kvarh
- Save: Press “SRVC” button (>2 seconds) until the LCD flashes

Configuration of the Pulse Duration

- “Arrow right” to settings
- “Arrow down” to S0 Impulse Duration
- Press “SRVC” button (<2 seconds)
- “Arrow right” increases the duration by 2ms starting from 4ms up to 250ms
- Save: Press “SRVC” button (>2 seconds) until the LCD flashes

TPC/IP

The EMU Professional II TCP/IP is equipped with a 100 MBit Ethernet-Interface and a RJ-45 connector.

Settings ex Factory

Ex-Factory the EMU Professional II obtains its IP-address via a DHCP-request.

The assigned IP-address can be read out on the display of the meter under “Settings” -> “IP-Address”. Navigate to “Settings” by pressing the “Arrow right” button and then use the “Arrow down” button to reach “IP-Address”.

Connection Diagram TCP/IP



Note: The TCP/IP interface is the same for both the EMU Professional II 3/100 TCP/IP and the EMU Professional II 3/5 TCP/IP.

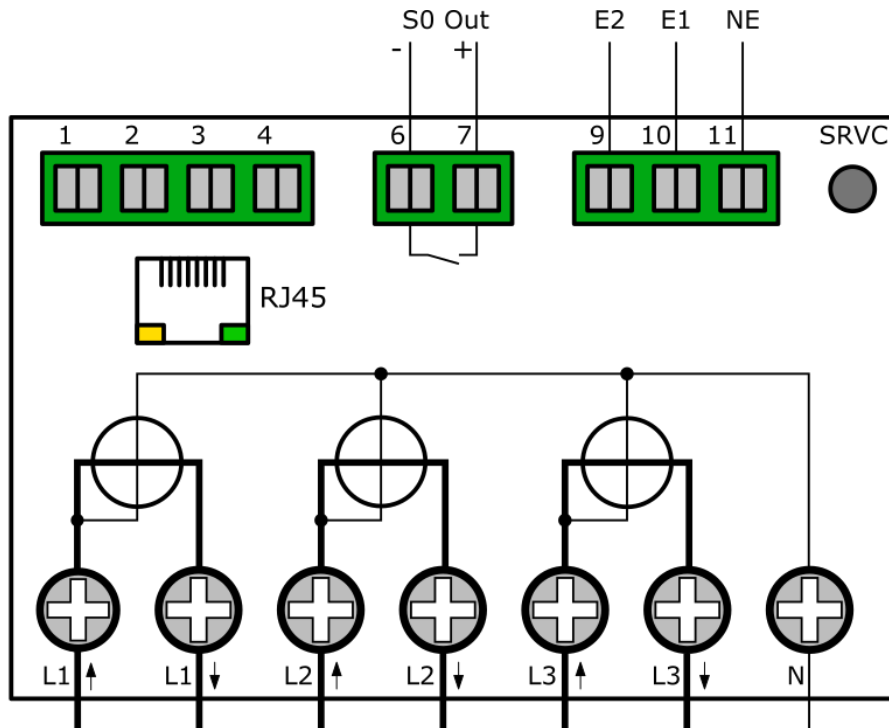

Configuration and Access

For further details on the EMU Professional II TCP/IP and its configuration please consult the document "Manual TCP/IP EMU Professional II" Doc.Ref: 1475.

ModBus RTU

The EMU Professional II Modbus supports communication via Modbus RTU.

Connection Diagram Modbus



Note: The Modbus interface is the same for both the EMU Professional II 3/100 Modbus and the EMU Professional II 3/5 Modbus.

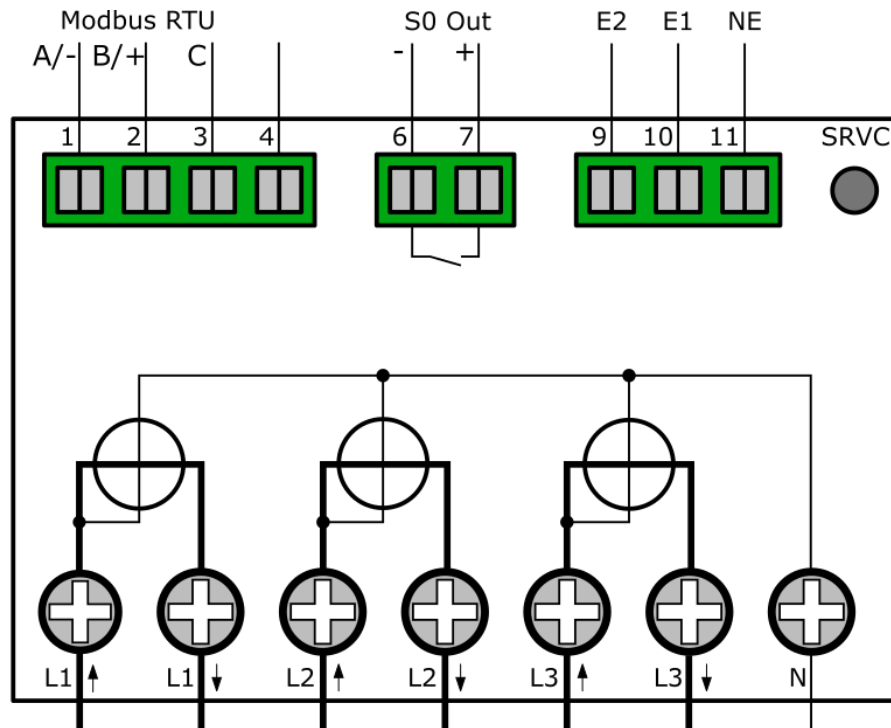

Configuration and Access

For further details on the EMU Professional II Modbus and its configuration please consult the document "Manual Modbus EMU Professional II" Doc.Ref: 1485.

LoRa

The EMU Professional II LoRa supports the communication via LoRa.

Settings ex Factory

The EMU Professional II LoRa sends the following values ex factory:

- Timestamp
- Active Energy Import Tariff 1&2
- Active Energy Export Tariff 1&2
- Error Code

Configuration and Access

For further details on the EMU Professional II Lora and its configuration please consult the document "Manual Lora EMU Professional II" Doc.Ref: 1490

In Case of Errors

In case you encounter an error on the EMU Professional II please consult the following list of common errors.

Possible Errors after Installation

Error: One or more phase currents show a negative sign

Solution: Check if the connections “S1↑” and “S2↓” (“Lx↑” and “Lx↓” for the direct meter) of the corresponding phase are connected correctly. “S1↑” (“Lx↑”) is **always** connected on the grid side, S2↓ (“Lx↓”) **always** on the user side.



DANGER: Make sure that all connected wires are voltage free before you check or change any connections. Touching any live elements is dangerous to life!

Wrong Meter Readings on the Converter Counter

Error: The EMU Professional II displays a way higher import than possible.

Solution: Please ensure that the current and voltage transformer ratios are set corresponding to the used transformers. The two ratios can be set on the EMU Professional II via the two touch buttons.

5 / 5 up to 20'000 / 5 A, in 5 A-steps. 1 / 1 up to 4'000 / 1 A, in 1 A-steps.

Behavior with Export and Import

The EMU Professional II records the energy flow in both negative (export) as well as positive (Import) direction in separate registers. The meter readings of import or export are **not** counted down or decreased.

The register “Active Energy Import” adds up all the imported energy from external sources. For this energy the customer receives an invoice from the local utility company. The register “Active Energy Export” adds up all the exported energy from you own sources (e.g. photovoltaics). For this energy the customer receives payment from the local utility company.

Practical example:

Current import of your complex at 1 pm:

Phase L1: 10kw
 Phase L2: 20kw
 Phase L3: 30kw
 Total ==> 60kw

Current export of your PV installation on this complex at 1 pm:

Phase L1: 25kw
 Phase L2: 25kw
 Phase L3: 25kW
 Total ==> 75kW

In this case you produce more power than your complex needs right now. The register “Active Energy Import” stays the same on L1 and L2 while the register “Active Energy Export” is increasing for L1 and L2 as you are exporting your surplus energy. For L3 its the other way around as you are still importing energy on Phase 3.

The EMU Professional II Sends Wrong Information on the S0 Interface

Check if the pulse rate and pulse duration of the EMU Professional II correspond with the ones of your receiver. The pulse rate as well as pulse duration can be configured via the two touch buttons.

Possible pulse rates / durations:

Pulse rates: 1, 10, 100, 1000 and 10000 Impulse per kWh / kvarh.

Pulse duration: 2ms, 10ms, 30ms, 40ms and 120ms.

The following values are set ex factory:

S0 Output	Active Energy Import (Pin 6 + 7)
Converter Counter	10 Pulses per kWh / Kvarh @ 120ms pulse duration
Direct meter	1000 Pulses per kWh / Kvarh @ 40ms pulse duration

Tariff Change Does Not Work

Tariff 1 is set ex factory. Make sure the tariff inputs are connected correctly.

E2 (Pin 9)	E1 (Pin 10)	Tariff
0	0	1
0	1	2
1	0	3
1	1	4



Note: For load profile measurements according to PTB-A 50.7 the two-rate tariff is mandatory. Tariff changes are set at the start of the next regular interval.



DANGER: Make sure that all connected wires are voltage free before you check or change the tariff connections. Touching any live elements is dangerous to life!

Extended Information for Load Profile According to PTB-A 50.7

Measurement Correctness Note

Auflagen für den Verwender im Sinne des § 23 der Mess- und Eichverordnung

Die Mess- und Eichverordnung verpflichtet diejenigen, die im Sinne des Eichrechtes Verwender eines Messgerätes sind, so zu messen und Messgeräte so zu handhaben, dass die Richtigkeit der Messung gewährleistet ist. Verwender im Sinne des Eichrechtes unter Berücksichtigung der Regelung von Marktrollen durch das Messstellenbetriebsgesetz sind:

- Messgeräteverwender:
 - Messgeräteverwender sind die Messstellenbetreiber im Sinne des Messstellenbetriebsgesetzes.
- Messwertverwender:
 - Messwertverwender sind die, die im Sinne des Messstellenbetriebsgesetzes Messung und Messwertweitergabe an berechnete Dritte durchführen, sowie Abrechnung der Netznutzung und Energielieferung durchführen.

Die Messgeräteverwender trifft die Aufgabe, den Messwertverwendern die Möglichkeit zu verschaffen, sich über die nachfolgend erläuterten Auflagen in Kenntnis zu setzen.

Transparenz der Verwendung

Der Messwertverwender hat für die Stromkunden, bei denen die Geräte verwendet werden, das Zustandekommen der in Rechnung gestellten Arbeits- und ggf. Leistungswerte transparent zu machen. "Transparent machen" heißt, durch Information die Voraussetzungen für die Stromkunden schaffen, um unter Zuhilfenahme eichrechtkonformer Anzeigen der bei ihnen verwendeten Geräte das Zustandekommen der Rechnungsposten in der Stromrechnung nachvollziehen zu können. Insbesondere ist dabei auch darüber zu informieren,

- Welche der von den Geräten angezeigten Werte überhaupt für Verrechnungszwecke herangezogen werden dürfen,
- Dass nicht angezeigte Werte nicht für Verrechnungszwecke verwendbar sind und dass angezeigte Werte, die Ergebnisse von nicht eichrechtlich relevanten Funktionen sind, rein informativen Charakter haben und ebenfalls nicht für Verrechnungszwecke verwendet werden können. Die Messgeräte müssen im Übrigen so verwendet werden, dass die Ablesbarkeit der verrechnungsrelevanten Messergebnisse und der Fehlermeldungen auch für die Stromkunden gegeben ist.

Tarifierung

Für die eichrechtskonforme Verwendung der Zählerstandgänge können nur die Tarife T1 und T2 verwendet werden.

Dabei ist der § 33 MessEG zu beachten:

Diesbezüglich hat der Messwertverwender dafür zu sorgen, dass Rechnungen, soweit sie auf Messwerten beruhen, von demjenigen, für den die Rechnungen bestimmt sind, in einfacher Weise zur Überprüfung angegebener Messwerte nachvollzogen werden können und für diesen genannten Zweck falls erforderlich geeignete Hilfsmittel bereitzustellen. Es muss immer sichergestellt werden, dass alle Register welche zur Abrechnung verwendet werden auch am Display angezeigt werden.

Fehlermeldungen / Uhrzeitverstellungen

Fehlermeldungen:

In den Begleitdokumenten werden die Geräte-Funktionsfehler beschrieben, die die hier genannten Zähler selbst diagnostizieren und anzeigen können. Bei Auftreten eines oder mehrerer der als „Eichrechtlich relevante Fehlermeldungen“ bezeichneten Ereignisse ist die eichrechtskonforme Verwendung nicht mehr gewährleistet und die gespeicherten Messergebnisse sind als dubios anzusehen. Die Geräte müssen ausgebaut, nötigenfalls repariert und geeicht werden, wenn sie weiterhin für Verrechnungszwecke verwendet werden sollen.

Uhrzeitverstellung:

Bei Zählern mit über Fernsteuerung veränderbarer, interner Uhr muss durch technische Maßnahmen sichergestellt werden, dass am Zähler über eichrechtskonforme Anzeigen nachprüfbar ist, ob die Mess- und Abrechnungsrichtigkeit beeinflussende Verstellung der Uhr während eines Abrechnungszeitraumes erfolgt sind. Bei den hier genannten Zählern wird das wie folgt erreicht:

Ein Kommando zum Verstellen der Zähleruhr über eine der vorhandenen Schnittstellen führt immer zu einem Eintrag in das eichtechnische Logbuch. Die aktuelle Registrierperiode nach dem Zeitpunkt der Uhrverstellung wird ungültig markiert.

Die mit dem Uhrzeitverstellen neu begonnene Registrierperiode endet beim nächsten ganzzahligen Vielfachen der Registrierperiodenlänge (bei x Uhr 15, 30, 45 oder 00) basierend auf der neu eingestellten Zählerzeit.

Verwendung der Kommunikationsschnittstellen

Die Kommunikationsschnittstellen der Zähler sind nicht eichrechtskonform. Über sie ausgelesene Messwerte der hier zuzulassenden Zähler können nur insoweit für Verrechnungszwecke verwendet werden, wie es sich gemäß Anlage 2, Abschnitt 8.1 der Mess- und Eichverordnung um eine unveränderte Wiederholung der im Display der hier zuzulassenden Zähler angezeigten Messergebnisse handelt.

Zeitsynchronisierung

Die hier genannten Zähler synchronisieren sich über die vorhandene Kommunikationsschnittstelle. Für eine eichrechtskonforme Verwendung der Zählerstandgänge muss der Verwender sicherstellen, dass die Uhrzeit des Zählers auf die gesetzliche Zeit synchronisiert wird. Bei den hier zuzulassenden Zählern müssen folgende Voraussetzungen erfüllt sein, bevor das Datentelegramm mit Datum und Uhrzeit gesendet wird:

- Der M-Bus muss zur Kommunikation frei sein
- Die Sekunden der aktuellen Uhrzeit müssen bei 00 sein (das Telegramm darf nur zur vollen Minute übertragen werden)
- Als Zeitquelle muss die gesetzliche Zeit verwendet werden

Können die Voraussetzungen nicht erfüllt werden, dürfen die Zählerstandgänge nicht für abrechnungsrelevante Zwecke verwendet werden.

Messergebnisse, die nicht für Verrechnungszwecke verwendet werden dürfen

Messwerte anderer als der in der Baumusterprüfbescheinigung genannten Messgrößen dürfen nicht für Verrechnungszwecke verwendet werden.

Logbuchfunktion

Die hier genannten Zähler verfügen immer über ein eichtechnisches Logbuch, das nur unter Verletzung einer herstellerseitigen Zugriffssicherung gelöscht werden kann.

EMU Professional II

The following chapter describes the menu items relevant to the load profile in greater detail. The load profile of the EMU Professional II is certified for PTB-A 50.7. For the LP version of the EMU Professional II the following information supersedes any information in this document prior to this chapter.

Current- and Voltage-transformer Ratio

These ratios set the applied factor while measuring energy and must be set according to the used current and/or voltage transformers. The adjustment of these ratios is only possible using the SRVC button. The SRVC button can be sealed with an anti-tamper seal.

Real Time Clock

The real time clock (RTC) displays the currently valid time of the device. We recommend setting the RTC to UTC as the meter does not support timezones and daylight-saving time. The adjustment of the real time clock is only possible using the SRVC button. The SRVC button can be sealed with an anti-tamper seal.

S0 Impulse Output

The S0 Impulse output can be set to the following:

- Active Energy Diff: All active Energy, either import or export, is output without differentiating.
- Reactive Energy Diff: All reactive Energy, either import or export, is output without differentiating.
- Active Energy Import: Only active energy import is output. All other energies are ignored.
- Reactive Energy Import: Only reactive energy import is output. All other energies are ignored.
- Active Energy Export: Only active energy export is output. All other energies are ignored.
- Reactive Energy Export: Only reactive energy export is output. All other energies are ignored.

The interface outputs an electrical pulse per set energy unit. With the following settings, the imported / exported energy can be calculated:

- Impulse ratio: Set the amount of pulses per unit of energy measured.
- Impulse length: Set the length of the pulse.

The adjustment of the S0 Impulse output is only possible using the SRVC button. The SRVC button can be sealed with an anti-tamper seal.

Use for Billing Purposes

The LP version of the EMU Professional II is only certified for billing purposes of active energy measurements. These measurements can be accessed at any time via the display or the meter's interface.

All other measurements are of a purely informative nature and may not be used for billing purposes. All measurements not shown on the display but retrievable over an interface are of a purely informative nature as well and may not be used for billing purposes.

Description

The load profile functionality according to PTB-A 50.7 consists of 2 separate functionalities:

- The load profile storage for the recording of measurements. This storage space is a ring buffer. After reaching the maximum possible entries, the oldest 27 entries are deleted and overwritten. This overwriting happens in batches of 27 entries due to technical factors.
- The logbook storage (official calibration certified logbook) for the recording of changed made to the parameters relevant for the load profile. The logbook cannot be tampered with without destroying the adhesive seal labels. The changes that are recorded are the following:
 - Adjustment of time and date
 - Adjustment of voltage of current transformation ratio.
 - Adjustment of S0 impulse ratio, S0 impulse duration

Each of the values mentioned above can only be adjusted once in every measurement interval. Further changes can only be done after the next interval has started.

Internal memory only allows for 2048 logbook entries. These entries can neither be deleted nor overwritten. Once this logbook memory is depleted the meter goes into the “not certified” status if one of the parameters mentioned above is changed again.

Once this status is set, a “PTB NV” message is shown on the display. All measured load profiles after this setting are marked as “NV” (Not valid).



Note: The “PTB-NV” status of the meter cannot be reversed in any way due to legal restrictions.

Interval of Recording

The interval for recording load profiles on the LP version of the EMU Professional II is set at 15 minutes and cannot be changed.

Time Synchronization

Synchronizing of the time may be done over a predefined command over the M-Bus / TCP-IP interface. The data sent includes time and date. The synchronization is immediate and is acknowledged by the meter with a “ACK” message. The time can be synchronized or set only once every measurement interval (15min). The time set must be the legal time.

An internal buffer supplies the RTC for at least 18 days (The meter needs to be powered for at least 2 hours to charge this buffer). The EMU Professional II LP differentiates between the following two time adjustments:

- Synchronization: If the difference between old and new time is less than 9 seconds (1% of load profile interval) the meter sets the new time without generating a logbook entry.
- Time set: If the difference is more than 9 seconds the time change will not count as a regular synchronization and will generate a logbook entry.

The internal RTC buffer for continued timekeeping even during blackouts and power fails lasts for at least 18 days. For this the meter must be powered for 2 hours beforehand.



Note: The EMU Professional II operates with internal timestamps that get set anew with every time synchronization. The EMU Professional II knows if more than 2 weeks have passed since the last synchronization even if it is powered down for more than 2 weeks (but less than 18 days).

The notifications TNV, TNS or NTP can appear on the display. The following diagram explains when and why they appear and the consequences:

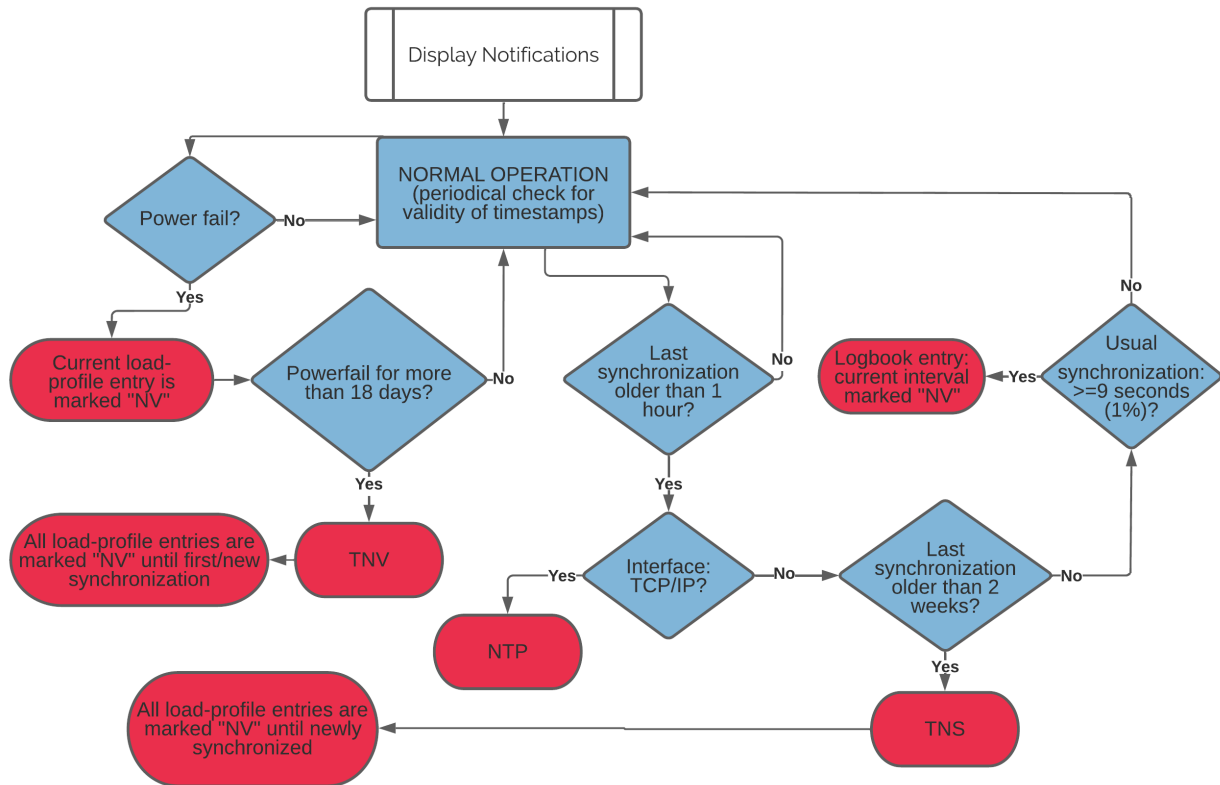

Note: According to the PTB-A 50.7 Certificate the time must be synchronized at least once every 2 weeks. If no synchronization occurs within these 2 weeks all load profiles after these 2 weeks are marked as "NV" until the next synchronization occurs. The message "TNS" is displayed.



Note: Ex Factory the internal buffer for the RTC is not charged. Therefore the meter has to be treated as if it's in "powerfail for more than 18 days" (TNV) status.

Tariff Changes

A change of tariff on the LP version (PTB 50.7 certified) of the EMU Professional II is set at the beginning of the next interval. A tariff is therefore always set for at least one interval period. For the LP version only the two-rate tariff is available.

The tariff is set via the 3 tariff inputs (Clamps 9-11) on the back of the meter.



Note: It is possible for a wrong tariff to be displayed after a power failure. The first load profile is set as "NV" regardless and the correct tariff is set correctly at the start of the next interval according to the tariff inputs NE, E1 and E2.



Note: For load profile measurements according to PTB-A 50.7 the two-rate tariff is mandatory. Tariff changes are set at the start of the next regular interval.

External Read-out over Interfaces

Read-out over external interfaces can be used for billing purposes. The interfaces send the same information as is shown on the display.

Memory Capacity

The internal memory capacity can store:

- Continual entries for the load profile: 105378
 - With a save interval of 15 minutes the EMU Professional II can store load profiles reaching back approx. 3 years. Once the memory is full, the memory handler deletes the first 26 entries and jumps back to the first entry. Once all 26 entries are filled again, the next 26 entries are deleted. This means only the newest 105352 load profile entries are available and older ones are deleted.
- Logbook entries: 2048
 - Each adjustment of the current or voltage ratio, the real time clock or the S0 interface results in an entry into the logbook. Once all 2048 entries are used the meter sets all load profiles after the next change to one of the above factors to "NV" according to PTB-A 50.7. A meter in this status must be replaced.

Power Failure and Reboot

Power Failure

All load profiles are saved and stored in a fixed 15-minute interval e.g. XX:00, XX:15, XX:30 and XX:45. After a power failure, the normal interval continues.

An Example:

- Current time: 07:37 => last load profile entry was at 07:30
- Power failure until 08:12
- Next entry happens on schedule at 08:15 (This entry is marked "NV" automatically)
- The entries for 07:45 and 08:00 are missing.

After every power failure the first load profile is marked as "NV". In case the internal buffer for the RTC sustained the meter through the power failure all further entries are **not** marked "NV".

Reboot

In rare instances an internal meter reboot may occur. In these cases the corresponding load profile entry is marked with "NV".

Display Load Profile

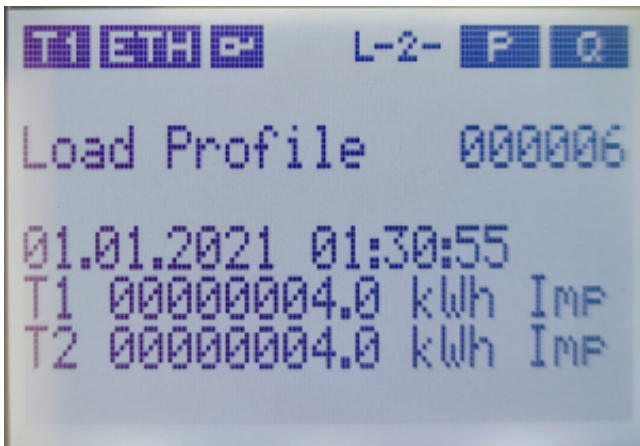

The load profile menu always shows the latest entry on call up. Once all 110'457 entries are full, the EMU Professional II automatically deletes the oldest 26 entries. The numeration of the load profiles however does not jump back to 0 but continues as if nothing happened.

Example: Your EMU Professional II 3/100 has already saved 200'000 load profiles. If you go through the list of load profiles you will start with load profile nr. 200'000. If you go back 105'378 entries you will jump back to load profile nr. 200'000. The data for load profile nr. 1-94'622 has been overwritten.

The following information is shown on the display:

000006: Index of the shown entry. The first entry has index 1 and the button "Arrow Down" lets you go through all stored load profiles (chronologically descending).

01.01.2021 01:30:55: Time stamp of the entry. Current time and date. This is the time the device had on the internal clock at the time of saving. There is no internal differentiation of timezones.

NV: Validity flag. The following situations result in a load profile being marked with "NV":

- If any of the above mentioned device parameters are adjusted, the load profile of that time interval is marked with "NV"
- The first entry after the startup of the meter is always marked as "NV". This is due to the assumption that the startup happens because of a prior power fail.
- If a time synchronization does not happen within 2 weeks of the last one, all entries after these 2 weeks are marked "NV".

Valid entries do not have any markings.

T1 / T2 00000000.0 kWh: Meter reading per tariff. Value of the active energy register at the time of the entry.



Note: For load profiles according to PTB-A 50.7 only a two-rate tariff is available. Tariff changes are set at the start of the next interval.

Imp / Exp: Change between import and export register. A long press (>2s) on the "Arrow Down" button lets you change between import and export data.

Display Logbook

The logbook always shows the latest entry on call up. The following information are shown on the display:

In Case of a Time Adjustment

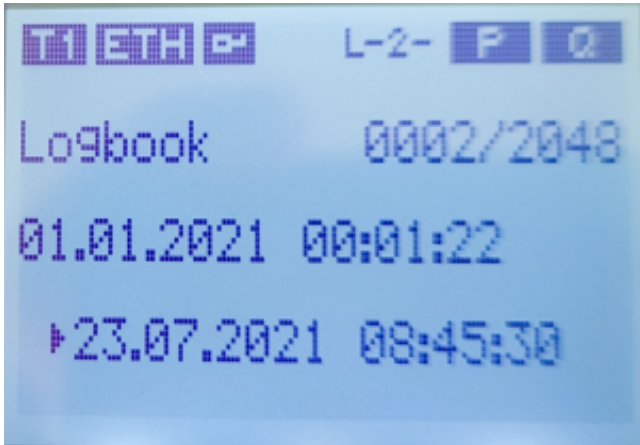

0002 / 2048: Index of the current entry. The entries start with 1 and can be browsed by pushing the “Arrow Down” button (chronologically descending).

01.01.2021 00:01:22: Valid time up until now. This also corresponds to the time of adjustment.

23.07.2021 08:45:30: Newly set time.

A short press (<1s) on the “Arrow Down” button lets you browse the saved logbook entries. The entries always start with the latest entry.

A longer press (>2s) of the “Arrow Down” button lets you see the meter readings at the time of adjustment (Import and Export).

In Case of a Ratio Adjustment

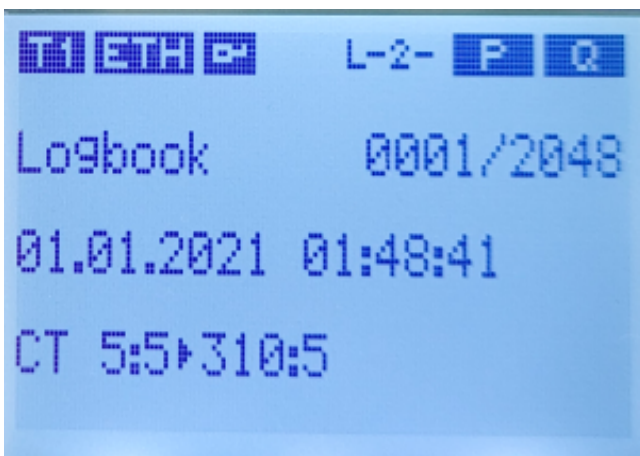

0001 / 2048: Index of the current entry. The entries start with 1 and can be browsed by pushing the “Arrow Down” button (chronologically descending).

01.01.2021 01:48:41: Time of the adjustment.

VT 5:5 -> 310:5: Old factor and new factor.

A short press (<1s) on the “Arrow Down” button lets you browse the saved logbook entries. The entries always start with the latest entry.

A longer press (>2s) of the “Arrow Down” button lets you see the meter readings at the time of adjustment (Import and Export).

In Case of a Impulse Duration Adjustment

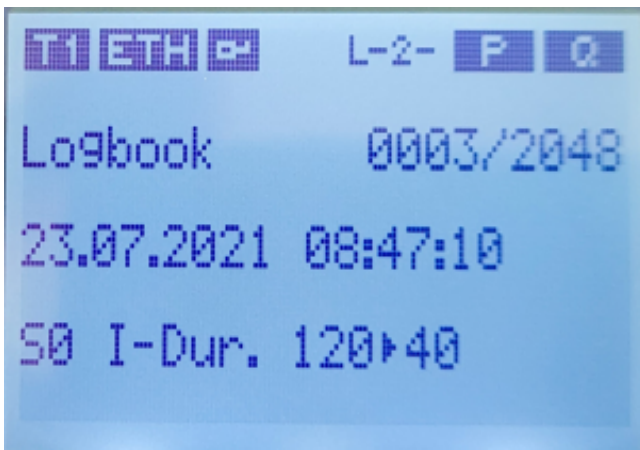

0003 / 2048: Index of the current entry. The entries start with 1 and can be browsed by pushing the “Arrow Down” button (chronologically descending).

23.07.2021 08:47:10: Time of the adjustment.

S0 I-Dur. 120 -> 40: Old factor and new duration in ms.

A short press (<1s) on the “Arrow Down” button lets you browse the saved logbook entries. The entries always start with the latest entry.

A longer press (>2s) of the “Arrow Down” button lets you see the meter readings at the time of adjustment (Import and Export).

In Case of a Impulse Rate Adjustment

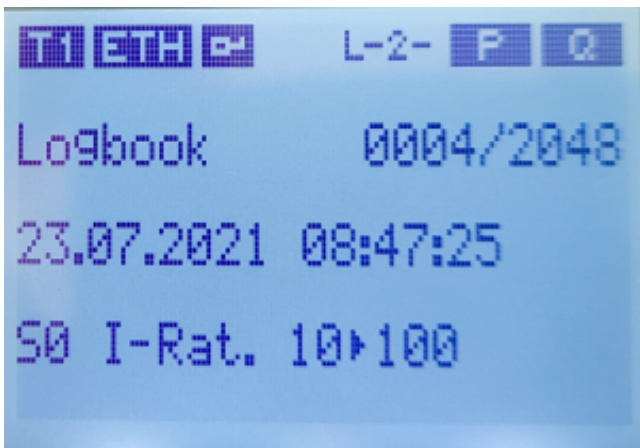

0004 / 2048: Index of the current entry. The entries start with 1 and can be browsed by pushing the “Arrow Down” button (chronologically descending).

23.07.2021 08:47:25: Time of the adjustment.

S0 I-Rat. 10 -> 100: Old ratio and new ratio in Imp / kWh

A short press (<1s) on the “Arrow Down” button lets you browse the saved logbook entries. The entries always start with the latest entry.

A longer press (>2s) of the “Arrow Down” button lets you see the meter readings at the time of adjustment (Import and Export).

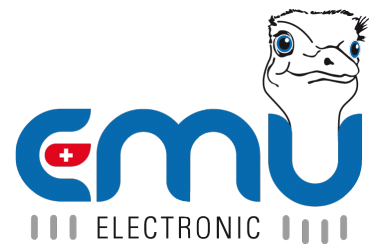

EMU Metering GmbH

Friemarier Str. 38
99867 Gotha
Deutschland

Phone: +49 (0)3621 510 40 70

hello@emu-metering.de
www.emu-metering.de

EMU Electronic AG

Jöchlerweg 2
CH-6340 Baar
Switzerland

Phone: +41 (0)41 545 03 00

helpdesk@emuag.ch
www.emuag.ch