



# Smart Fan Coil Thermostat

Featuring LoRaWAN®

**WT30x**

User Guide



## Safety Precautions

Milesight will not shoulder responsibility for any loss or damage resulting from not following the instructions of this operating guide.

- ❖ The device must not be disassembled or remodeled in any way.
- ❖ The device is not intended to be used as a reference sensor, and Milesight will not should responsibility for any damage which may result from inaccurate readings.
- ❖ Do not place the device where the temperature is below/above the operating range.
- ❖ Do not place the device close to objects with naked flames, heat source (such as oven), or exposure to sunlight, cold source, liquid, and extreme temperature changes.
- ❖ The device must never be subjected to shocks or impacts.
- ❖ Do not clean the device with detergents or solvents such as benzene or alcohol. To clean the device, wipe with a soft moistened cloth. Use another soft, dry cloth to wipe dry.

## Declaration of Conformity

WT30x is in conformity with the essential requirements and other relevant provisions of the CE and RoHS.



**Copyright © 2011-2023 Milesight. All rights reserved.**

All information in this guide is protected by copyright law. Whereby, no organization or individual shall copy or reproduce the whole or part of this user guide by any means without written authorization from Xiamen Milesight IoT Co., Ltd.

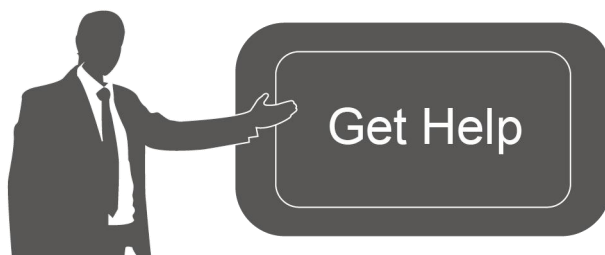

For assistance, please contact

Milesight technical support:

Email: [iot.support@milesight.com](mailto:iot.support@milesight.com)

Support Portal: [support.milesight-iot.com](http://support.milesight-iot.com)

Tel: 86-592-5085280

Fax: 86-592-5023065

Address: Building C09, Software Park  
Phase III, Xiamen 361024,  
China

## Revision History

Date	Doc Version	Description
Dec. 20, 2023	V 1.0	Initial version

# Contents

1. Product Introduction .....	5
1.1 Overview .....	5
1.2 Key Features .....	5
2. Hardware Introduction .....	5
2.1 Packing List .....	5
2.2 Hardware Overview .....	6
2.3 Dimensions (mm) .....	6
3. Wiring Diagrams .....	7
4. Installation .....	8
5. Operation Guide .....	9
5.1 Basic Settings .....	10
5.2 Advanced Settings .....	11
5.3 LoRaWAN® Settings .....	14
6. Communication Protocol .....	15
6.1 Device Data .....	15
6.2 Downlink Control Commands .....	16
6.3 Downlink Enquiry Commands .....	17
Appendix .....	18
Default Frequency .....	18
Default RX2 Frequency and Datarate .....	19

# 1. Product Introduction

## 1.1 Overview

WT301&WT302 is an advanced touch screen room thermostat specifically developed to oversee fan and valve operations in air conditioner applications where fan coil unit (FCU) is adopted. It achieves this by continuously comparing the environmental temperature with the pre-set desired temperature, enabling both proactive management and automatic control based on predefined logic. This ensures optimal comfort and energy efficiency in the controlled environment.

With wireless detection and easy configuration, the WT301&WT302 offers reliable and convenient room temperature arrangement optimization. It is compatible with standard LoRaWAN® gateway, enabling real-time monitoring of environmental status for effective remote management.

## 1.2 Key Features

- Adjust the room temperature automatically and manually with a time-controlled regulation
- Applicable for two pipes and 3-Speed fan coil system, compatible with On/Off relay (WT301) or 0-10V (WT302) valve control
- 5+1+1 six periods programmable maximize comfort and economy
- High accuracy of 0.5°C for temperature regulation, enabling precise control of indoor temperature levels
- Adopts an LCD screen with Four-color LED and capacitive touch buttons, providing a better interactive experience
- With clock display function
- With a 12cm ultra-thin embedded panel and a sleek, frameless design, it effortlessly blends into different interior styles, offering a minimalist and elegant appearance
- Equips with external NTC sensor signal input and keycard switch input
- Function well with standard LoRaWAN® gateways and network servers
- Easy to install with the compact size
- Highly adapt to different scenarios with 86mm hidden box and European 60mm round box

# 2. Hardware Introduction

## 2.1 Packing List



1 x WT30x Device



2 x Mounting Screws



1 x Quick Start Guide



1 x Warranty Card

**!** If any of the above items are missing or damaged, please contact your sales representative.

## 2.2 Hardware Overview

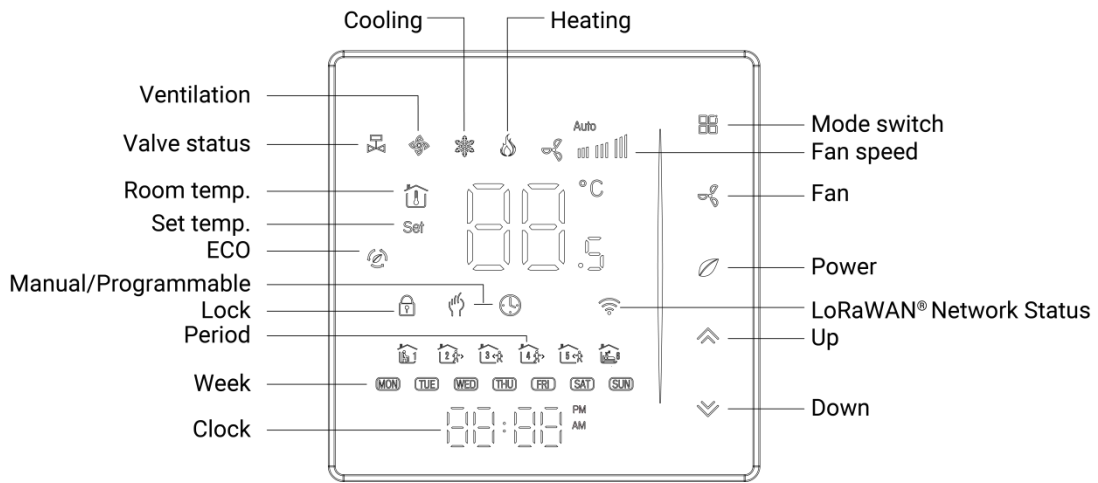

### Screen Descriptions:

Icon	Description
	Blinks: the network is de-activated
LoRaWAN® Network Status	Static On: the network is activated

## 2.3 Dimensions (mm)

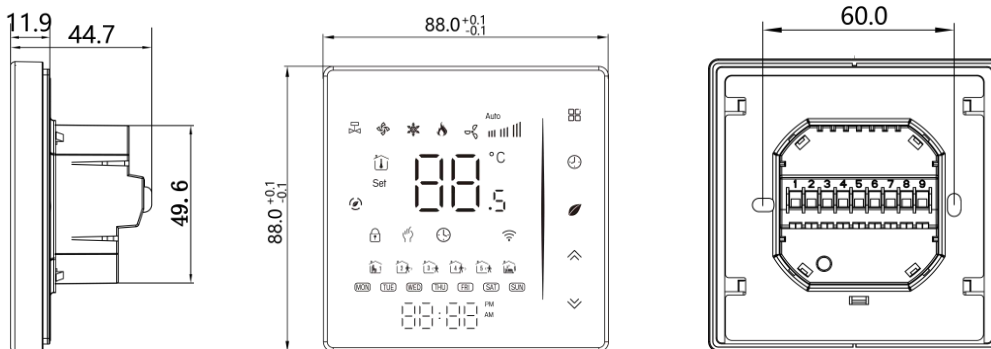

### 3. Wiring Diagrams

#### 1. WT301

AC95 ~ 240V 50/60Hz

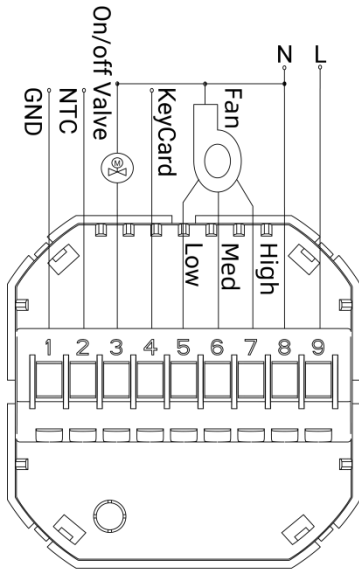

Two Pipe, On/off

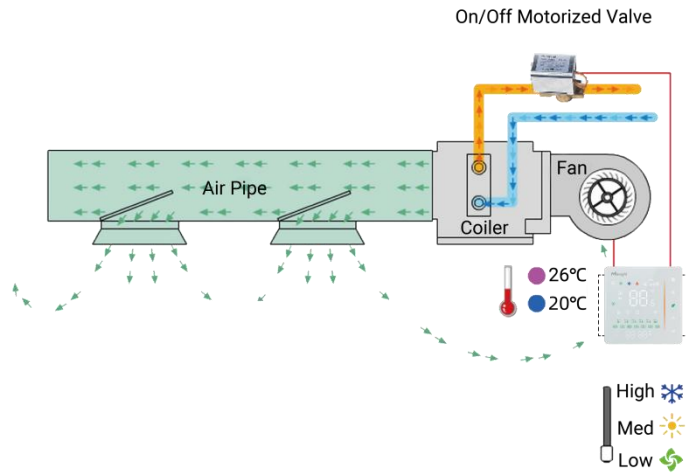

Fan Coil Unit Control Chart

#### 2. WT302

AC95 ~ 240V 50/60Hz

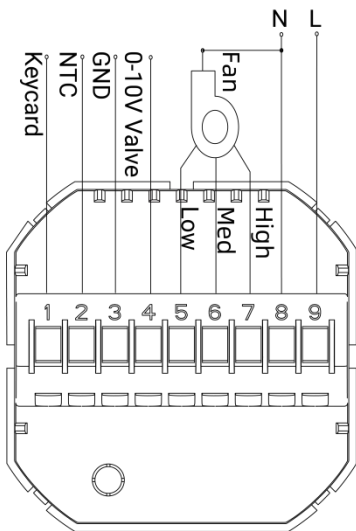

Two Pipe, 0-10V

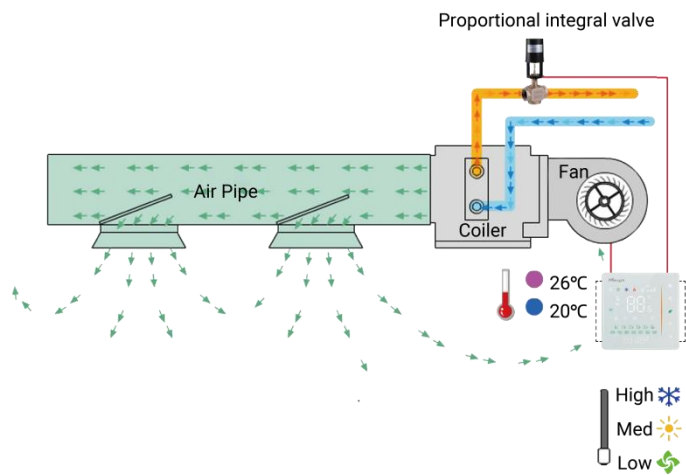

Fan Coil Unit Control Chart

## 4. Installation

### Installation Locations

It is suggested to install the WT30x thermostat about 5 ft. (1.5m) above the floor in an area with good air circulation at average temperature.

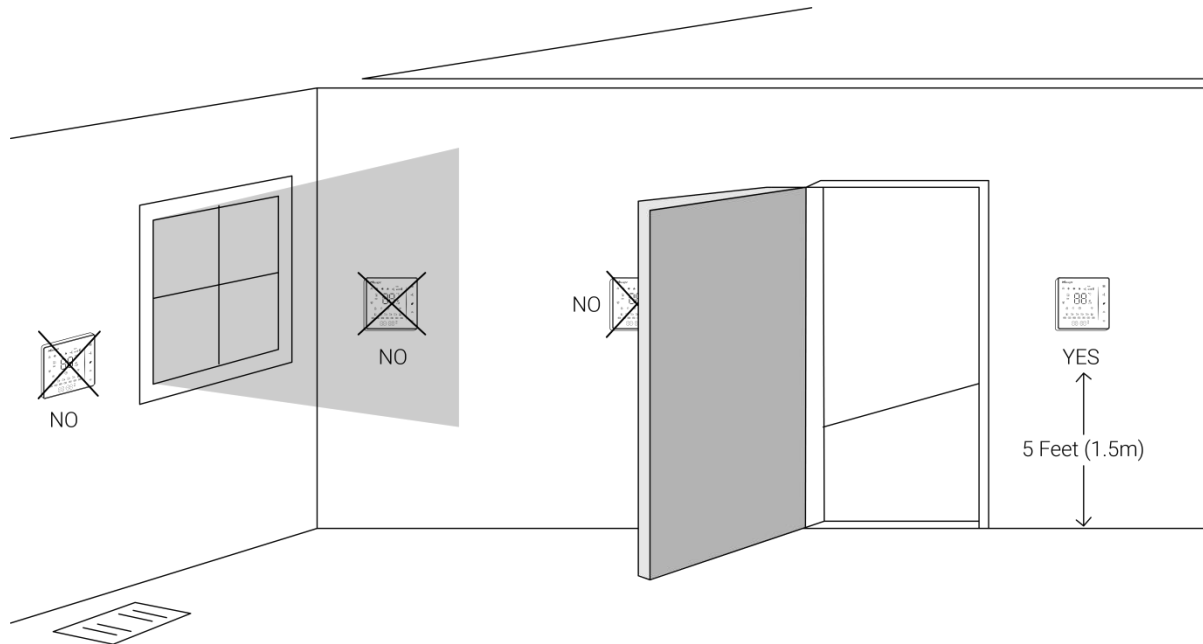

Do not install the device where:

- Close to hot or cold sources like hot or cold air ducts;
- The place in direct sunlight;
- Dead spots or drafts (behind the doors and in corners);
- In areas that do not require conditioning;
- Close to concealed chimneys or pipes;
- Close to metal objects and obstacles which affect the LoRaWAN® transmission;
- The place with lots of electromagnetic interfaces;
- The place where strong vibration may happen or easy to be subjected to physical shock.

### Installation Steps

WT30x is suitable for installation within a standard 86mm pattress box or European 60mm pattress box.

1. Ensure the circuit of all related systems are shut off before installation.
2. Connect corresponding wires to appropriate terminals of WT30x device.



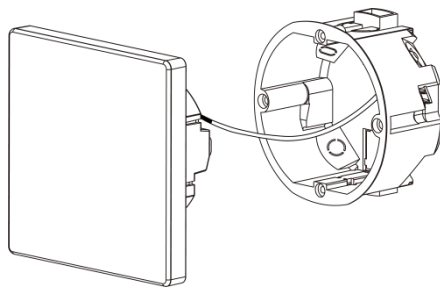

3. Remove LED screen from the mounting plate by pushing the LED screen assembly.

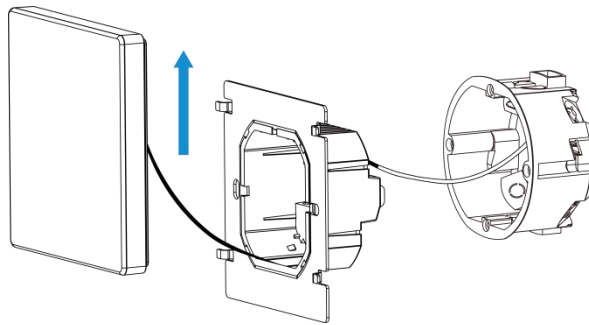

4. Fix the mounting plate into the wall with mounting screws.

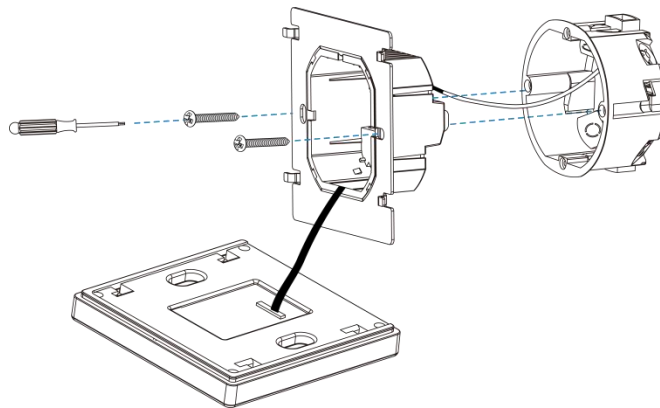



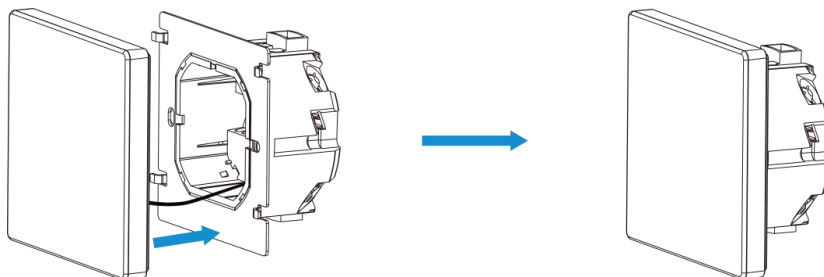

5. Fix the LED screen back to the mounting plate.



## 5. Operation Guide

WT30x supports to configure device via 5 buttons. In the guide will use below names to indicate every button:

Button	Name
	MODE
	FAN
	POWER
	UP
	DOWN

## 5.1 Basic Settings

### 1. Power On/off

Press "POWER" button to turn the thermostat on/off. When button lights green, the thermostat is on; when the power button is off, the thermostat is on.

**Note:**

- 1) When the buttons are not pressed for more than 3 seconds, the LED screen will go off; please press the corresponding button configure the device as usual.
- 2) Below operations only work when the thermostat is on.

### 2. Switch System Mode



Press "MODE" button to switch the system mode among HEATING, COOLING and VENTILATION. In the mode of VENTILATION, the valve is off but the fan runs.

### 3. Switch the Fan Speed

Press "FAN" button to switch the fan speed among AUTO, HIGH, MED, LOW.

### 4. Adjust Manual & Programmable Mode

**Operation:** press and hold on "MODE" button → manual and programmable mode icons flashes by turns → loose "MODE" button → press "UP" button to select manual mode/ press "DOWN" button to select programmable mode.

Icon	Mode	Description
	Manual	This mode supports to use "UP" and "DOWN" buttons to adjust target temperature manually.
	Programmable	This mode supports to control the temperature according to weekly programmable schedule. The "UP" and "DOWN" buttons will not work.

## 5. Adjusting/Setting the Clock

**Operation:** press and hold on "MODE" button → manual and programmable mode icons flashes by turns → loose "MODE" button → press "MODE" button once to adjust minute of time → press "MODE" button once to adjust hour of time → press "MODE" button once to adjust weekday.

When you stop pressing the buttons for seconds, the device will save your settings automatically.

## 6. Locking the Thermostat Buttons

Press and hold the "UP" and "DOWN" buttons together for 3 seconds to enable/disable button lock of your thermostat. When button lock is enabled, the lock icon will display. WT30x supports two lock modes: full lock and half lock. The lock mode can be set on advanced settings.

## 7. Adjust the Weekly Programmable Schedule

WT30x supports to add up to 6 time periods and 6 temperature values during weekdays, Saturday or Sunday.

**Operation:** press and hold on "MODE" button → manual and programmable mode icons flashes by turns → loose "MODE" button → press "MODE" button 4 times → press "UP" and "DOWN" button to adjust weekday-period 1 time → press "UP" and "DOWN" button to adjust weekday-period 1 temperature → press "UP" and "DOWN" button to adjust weekday-period 2 time → .....

After completing all settings, click "MODE" button to confirm and exit the schedule settings. Besides, when you stop pressing any button for a few seconds, the device will save your settings and exit the schedule setting mode.

**Default settings of programmable schedules are as follows:**

Time Display	Weekday (Mon. to Fri.)		Saturday		Sunday	
	Time	Temperature	Time	Temperature	Time	Temperature
Period 1	06:00	20°C	06:00	20°C	06:00	20°C
Period 2	08:00	15°C	08:00	20°C	08:00	20°C
Period 3	11:30	15°C	11:30	20°C	11:30	20°C
Period 4	13:30	15°C	13:30	20°C	13:30	20°C
Period 5	17:00	22°C	17:00	20°C	17:00	20°C
Period 6	22:00	15°C	22:00	15°C	22:00	15°C

## 5.2 Advanced Settings

Press the "POWER" button to turn off the thermostat, then press and hold on "MODE" and "FAN" buttons together for 5 seconds to reach advanced settings. After completing all settings, press "MODE" button to confirm and exit. Besides, when you stop pressing the button, the device will save your settings after a few seconds automatically and exit the advanced settings. These advanced settings will take effect after turning on the thermostat.

Code	Function	Settings and Options	Default
1	Temperature Compensation (Calibration)	-9°C~9°C, add this value to room temp.	-3°C
2	Fan Control	00: When room temp. reaches the set temp., the fan will turn off 01: When room temp. reaches the set temp., the fan will keep low speed running	00
3	Button Lock	00: half lock, all buttons are locked except "POWER" button 01: full lock, all buttons are locked	01
4	System Mode Selection	00: Cooling/Ventilation 01: Cooling/Heating/Ventilation	01
5	Min. Set Temp.	5°C~15°C (for "DOWN" button)	5°C
6	Max. Set Temp.	15°C~35°C (for "UP" button)	35°C
7	Time Mode	00: 12-Hour-Clock 01: 24-Hour-Clock	01
8	Display Mode	00: Display both set temp. and room temp. 01: Display set temp. only	00
9	Keycard Function (when keycard is no connected)	00: Energy saving(ECO) mode: goes to energy saving temp. 01: Standby: the fan and valve relay all off	00
10	Keycard heating energy-saving temperature	10°C~30°C	20°C
11	Keycard cooling energy-saving temperature	10°C~30°C	26°C
12	Daytime display brightness	0-8 <b>Note:</b> The daytime is the time between period 1 and period 6 of weekly schedule, the default is 6:00~22:00.	3
13	Night display brightness	0-8	1
<b>WT301 Only</b>			
14	Dead Zone Temp.	1°C~5°C	1°C

	(Set Temp. Tolerance)	The valve will start cooling when room temp. > (set temp. + dead zone temp.); start heating when room temp. < (set temp. – dead zone temp.).	
15	Report Interval	1~60 minutes	1 minute
16	LoRaWAN® Mode	00: SerialNet 01: AT MODE	00
17	Keycard Function	00: On 01: Off	01
18	Time Zone	0~24: the corresponding time zone -12~12 12 means time zone is UTC+0	12
19	Room Temp. Sensor	00: Use internal NTC or external NTC input sensor 01: Use external temperature data via downlink command	00
20	Version Number		U9

**WT302 Only**

14	Report Interval	1~60 minutes	1 minute
15	P Value	1-10	2
16	I Value	1-60s	40s
17	LoRaWAN® Mode	00: SerialNet 01: AT MODE	00
18	Keycard Function	00: On 01: Off	01
19	Time Zone	0~24: the corresponding time zone -12~12 12 means time zone is UTC+0	12
20	Room Temp. Sensor	00: Use internal NTC or external NTC input sensor 01: Use external temperature data via downlink command	00
21	Version Number		U9

**Definition of P Value**

The proportional band is the amount of change required by the ambient temperature for the output to go from 0 to 100%. It can be adjusted from 1~10. Factory default is 2.

The larger the P value, the greater the change in valve output; the smaller the P value, the smaller the change in valve output.

For example, when P=2, the temperature difference between ambient temperature and setpoint is 5°C, the valve will open about 10%; when P=4, the temperature difference between ambient temperature and setpoint is 5°C, the valve will open 20%.

### Heat mode (P-band: 2)

When the ambient temperature is below the set point the output is somewhere between 0~100%.

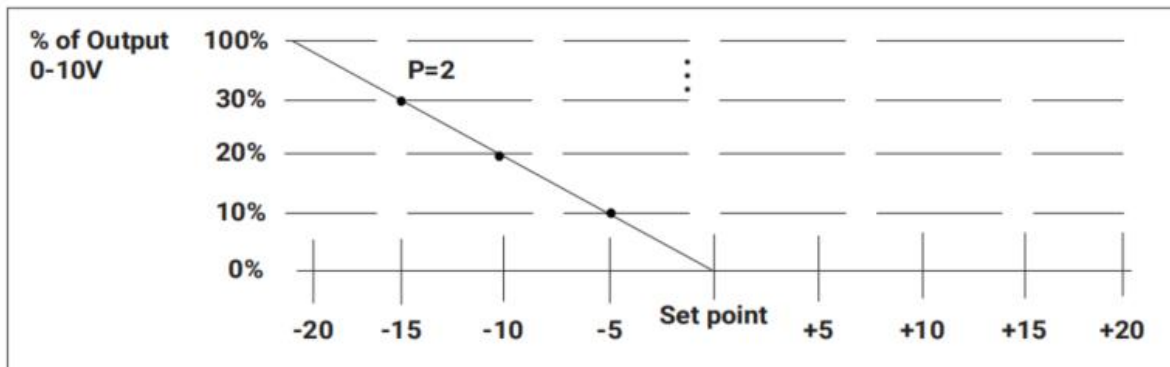

### Cool mode (P-band: 2)

When the ambient temperature is above the set point the output is somewhere between 0~100%.

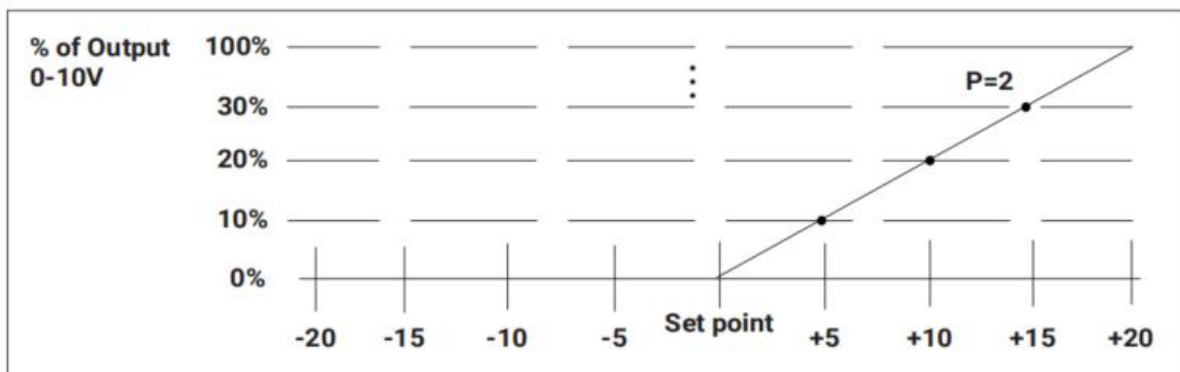

### Definition of I Value

This feature allows you to set the integral action time for the integral to run from 0 to 100%. The value required depends on the reaction time of the control loop. If the time is chosen too short, the control loop will become unstable and oscillate. If the time is chosen too long, the control loop will become sluggish. It can be adjusted from 1s-60s. The default value is 40s.

## 5.3 LoRaWAN® Settings

WT30x does not support to configure LoRaWAN® information. Please contact Milesight to customize the LoRaWAN® settings before purchase.

Parameters	Description	Default
Device EUI	Unique ID of the device.	On the label
App EUI	The default App EUI is 24E124C0002A0001.	24E124C0002A0001
Application Port	The port is used for sending and receiving data.	85
Join Type	OTAA and ABP modes are available.	OTAA

Application Key	Appkey for OTAA mode.	5572404C696E6B4C6F 52613230313823
Network Session Key	Nwkskey for ABP mode.	
Application Session Key	Appskey for ABP mode.	
Device Address	DevAddr for ABP mode.	Last 8 digits of Device EUI
LoRaWAN® Version	LoRaWAN® protocol version.	V1.0.3
Work Mode	It's fixed as Class C.	Class C
RX2 Data Rate	RX2 data rate to receive downlinks.	See appendix
RX2 Frequency	RX2 frequency to receive downlinks.	See appendix
Confirmed Mode	If the device does not receive an ACK packet from the network server, it will resend data once.	Off
ADR Mode	Allow network server to adjust data rate of the device.	On
Spread Factor	If ADR is disabled, the device will send data via this spread factor.	See appendix
Tx Power	Transmit power of the device.	SF9

## 6. Communication Protocol

### 6.1 Device Data

All data are based on following format (HEX):

Start	ID	Data Length	Data	Checksum
55	01	2 Bytes	2 Bytes or 10 Bytes	1 Byte

The Data part is consist of Type ID (1 Byte) and Data Content (1 Byte or 9 Bytes) :

Item	Type	Data & Description
Turn On/Off	01	00: Off, 01: On
Button Lock	02	01: Enable, 00: Disable
System Mode	03	00: Cooling, 01: Heating, 02: Ventilation
Fan Mode	04	00: Auto, 01: High, 02: Middle, 03: Low
Room Temperature	05	INT8/2, Unit: °C

Set Temperature	06	INT8/2, Unit: °C
Keycard Status	07	00: Disconnected, 01: Connected
Configuration Mode	08	00: Programme, 01: Manual
External Server Temperature	09	INT8/2, Unit: °C
All Data	0f	Reports all above data in order

**Examples:**

1. Periodic packet: report as reporting interval (1 minute by default) or when pressing the button to change the settings.

55 01 000a 0f 01000001332a000034 02					
Start	ID	Data Length	Data Type	Data Content	Checksum
55	01	00 0a=10 Bytes	0f	01=Turn On 00=Button Lock Disable 00=Cooling 01=High 33=>51/2=25.5°C (Room Temp.) 2a=>42/2=21°C (Set Temp.) 00=Keycard is disconnected 00=Programme Mode 34=>52/2=26°C (External Temp.)	02

## 6.2 Downlink Control Commands

WT30x supports downlink commands to configure the device. The application port is 85 by default. The command is based on following format (HEX):

Start	ID	Command Length	Command	Checksum
55	01	2 Bytes	2 Bytes or 8 Bytes	1 Byte

The Command part is consist of Type ID (1 Byte) and Command Content (1 Byte or 7 Bytes) :

Item	Type	Command & Description
Turn On/Off	01	00: Off, 01: On
Button Lock	02	01: Enable, 00: Disable
System Mode	03	00: Cooling, 01: Heating, 02: Ventilation
Fan Mode	04	00: Auto, 01: High, 02: Middle, 03: Low
Set Temperature	05	INT8/2, Unit: °C
Configuration Mode	06	00: Programme, 01: Manual



External Server Temperature	07	INT8/2, Unit: °C <b>Note:</b> this only takes effect when advanced setting-Room Temp. Sensor is set as 01.
All Commands	0f	Send all above commands in order

**Checksum Calculation:** sum of bytes % 256

#### Examples:

1. Turn on the device.

55 01 0002 0101 5a					
Start	ID	Command Length	Data Type	Command	Checksum
55	01	00 02=2 Bytes	01	01=Turn On	5a

2. Set all configurations:

55 01 0008 0f 010000012a0034 cd					
Start	ID	Data Length	Data Type	Command	Checksum
55	01	00 08=8 Bytes	0f	01=Turn On 00=Button Lock Disable 00=Cooling 01=High 2a=>42/2=21°C (Set Temp.) 00=Programme Mode 34=>52/2=26°C (External Temp.)	cd

## 6.3 Downlink Enquiry Commands

WT30x supports downlink commands to enquiry the device information. The application port is 85 by default. The command is based on following format (HEX):

Start	ID	Command Length	Data Type	Checksum
55	02	0001	1 Byte	1 Byte

Item	Data Type	Checksum
Turn On/Off	01	59
Button Lock	02	5a
System Mode	03	5b
Fan Mode	04	5c
Room Temperature	05	5d

Set Temperature	06	5e
Keycard Status	07	5f
Configuration Mode	08	60
External Server Temperature	09	61
All Data	0f	67

**Examples:**

1. Enquiry the room temperature.

<b>55 02 0001 05 5d</b>				
Start	ID	Data Length	Data Type	Checksum
55	02	00 01=1 Byte	05=Room Temperature	5d

Reply:

<b>55 01 0002 05 33 90</b>					
Start	ID	Data Length	Data Type	Data Content	Checksum
55	01	00 02=2 Bytes	05	33=>51/2=25.5°C	90

2. Enquiry all data.

<b>55 02 0001 0f 67</b>				
Start	ID	Data Length	Enquiry Type	Checksum
55	02	00 01=1 Byte	0f=All data	67

Reply: the same as periodic packet.

## Appendix

### Default Frequency

Supported Freq	Channel/MHz
CN470	471.9, 472.1, 472.3, 472.5, 472.7, 472.9, 473.1, 473.3 (8~15)
EU868	868.1, 868.3, 868.5
IN865	865.0625, 865.4025, 865.985
RU864	868.9, 869.1
AU915	916.8, 917, 917.2, 917.4, 917.6, 917.8, 918, 918.2 (8~15)
US915	903.9, 904.1, 904.3, 904.5, 904.7, 904.9, 905.1, 905.3 (8~15)
KR920	922.1, 922.3, 922.5

AS923-1	923.2, 923.4
AS923-2	921.4, 921.6
AS923-3	916.6, 916.8
AS923-4	917.3, 917.5

## Default RX2 Frequency and Datarate

Supported Freq	RX2 Frequency & Datarate
CN470	505.3MHz, DR0 (SF12, 125k)
EU868	869.525MHz, DR0 (SF12, 125k)
IN865	866.55MHz, DR2 (SF10, 125k)
RU864	869.1MHz, DR0 (SF12, 125k)
AU915	923.3MHz, DR8 (SF12, 500k)
US915	923.3MHz, DR0 (SF12, 500k)
KR920	921.9MHz, DR0 (SF12, 125k)
AS923-1	923.2MHz, DR2 (SF10, 125k)
AS923-2	921.4MHz, DR2 (SF10, 125k)
AS923-3	916.6MHz, DR2 (SF10, 125k)
AS923-4	917.3MHz, DR2 (SF10, 125k)

-END-