



THE NEW GENERATION LORAWAN SENSORS OF SENSECAP

# S210X Sensors User Guide

---

Version: v1.0.0



# Table of Contents

<b>1. Product Introduction .....</b>	<b>4</b>
<b>2. Part List .....</b>	<b>5</b>
<b>3. Key Parameters of the Sensor .....</b>	<b>6</b>
3.1 Introduction of Key Parameters .....	6
3.2 Get Device EUI, App EUI and Key .....	7
3.2.1 Get the parameters via API .....	7
3.2.1 Get the parameters via SenseCAP Mate App .....	8
<b>4. LED of Sensor Working Status .....</b>	<b>9</b>
<b>5. SenseCAP Mate App .....</b>	<b>11</b>
5.1 Download App .....	11
5.2 How to connect sensor to App .....	12
5.3 Configure parameters through App .....	14
5.3.1 Select the Platform and Frequency .....	14
5.3.2 Set the Interval .....	16
5.3.3 Set the EUI and Key .....	16
5.3.4 Set the Packet Policy .....	17
5.3.5 Set the Activation Type .....	18
5.3.6 Restore Factory Setting .....	19
<b>6. Connect to the SenseCAP Portal .....</b>	<b>20</b>
6.1 Quick Start .....	20
6.2 SenseCAP Portal .....	21
6.2.1 Create a New Account .....	21
6.2.2 Other Functions .....	22
6.2.3 API Instruction .....	22
6.3 Preparation .....	23
6.3.1 App .....	23
6.3.2 SenseCAP Gateway .....	24
6.4 Bind Sensor to SenseCAP Portal .....	25
6.4.1 Scan QR Code .....	25
6.4.2 Manually fill in the EUI .....	25
6.5 Setup the Sensor .....	27

---

6.6	Set Frequency of Sensor via SenseCAP Mate App .....	29
6.7	Check Data on SenseCAP Portal .....	31
<b>7.</b>	<b>Connect to Helium Network .....</b>	<b>32</b>
7.1	Register .....	32
7.2	Add New Device .....	33
7.3	Check the data on Helium .....	35
7.4	Upload Data from Helium to Datacake .....	36
7.4.1	Create a Datacake Account .....	36
7.4.2	Add New Integration on Helium Console .....	36
7.4.3	Configure the Flows on Helium .....	37
7.4.4	Add the Sensor on Datacake .....	39
7.4.5	Check Data from Datacake .....	42
<b>8.</b>	<b>Connect to The Things Network .....</b>	<b>45</b>
8.1	Preparation .....	46
8.1.1	Gateway Registration on TTN .....	46
8.1.2	Create the Application .....	46
8.2	Add Sensor to TTN Console .....	47
8.3	Check Data on TTN Console .....	49
<b>9.</b>	<b>Payload Decoder .....</b>	<b>50</b>
9.1	Decoder Code .....	50
9.2	Packet Parsing .....	51
9.2.1	Packet Initialization .....	51
9.3	Data Parsing Example .....	52
9.3.1	Measurements List .....	52
9.3.2	Example – S2101 Air Temperature and Humidity Sensor .....	53
9.3.1	Example – S2102 Light Intensity Sensor .....	54
9.3.2	Example – S2103 CO2, Temperature and Humidity Sensor .....	55
9.3.3	Example – S2104 Soil Moisture and Temperature Sensor .....	56
9.3.4	Example – S2105 Soil Moisture, Temperature and EC Sensor .....	57
9.4	Battery Information .....	58
<b>10.</b>	<b>Device Installation .....</b>	<b>60</b>
10.1	Installing Sensor .....	60
10.1.1	Installing the Sensor Bracket .....	60

---

10.1.1	Mount on Pole and Wall .....	61
10.2	Replace the Battery .....	63
10.2.1	How to Buy the Battery.....	63
10.2.2	How to Replace a New Battery .....	64
<b>11.</b>	<b>Trouble Shooting .....</b>	<b>66</b>
11.1	Support.....	66
11.2	Document Version.....	66



## 1. Product Introduction



Among the first launch of Seeed Industrial IoT product series, SenseCAP is focusing on wireless environmental sensing applications: smart agriculture, precision farming, smart city and so on. It consists of hardware products (sensors, data-loggers & gateways, etc.), software services (SenseCAP portal, mobile App, open dashboard), and API for device & data management.





The next generation of SenseCAP LoRaWAN sensors, the S210X series offers users' industrial long-distance data acquisition via LoRa. The S210x series is suitable for a wide variety of different industries such as smart agriculture, smart buildings and industrial control.

With the IP66 rating,  $-40 \sim +85^{\circ}\text{C}$  operating temperature and built-in 19Ah high-capacity battery, combined with the devices' low power consumption, the S210X series can operate in harsh outdoor environments for up to 10 years with a range of up to 10km. The built-in Bluetooth facilitates setup and greatly reduces large-scale deployment costs. Users can focus on application development with the easy set-up and start retrieving data in a few steps. Just install the device, bind it using the QR code and configure the network, then data can be viewed from the SenseCAP portal, which supports popular IoT protocols such as HTTP and MQTT.

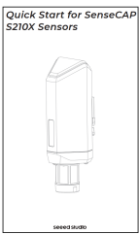

## 2. Part List

Before installing, please check the part list to ensure nothing is missing.

Picture	Name	Quantity
	Sensor Node	1
	Bracket	1
	Quick Start Guide	1
	KA4*20mm Self-drilling Screw	4



## 3. Key Parameters of the Sensor

### 3.1 Introduction of Key Parameters

Using the LoRaWAN protocol generally involves the following parameters.

Parameters	Description
LoRaWAN MAC Version	v1.0.3
Join Type	OTAA (Default) ABP (It can be modified through App)
Device EUI	Unique identification of device, one of the join network parameters (OTAA mode).
Device Code (KEY)	On the device label, for device binding and API call.
App EUI	Unique identification of application, one of the join network parameters (OTAA mode).
App Key	Application key, one of the join network parameters (OTAA mode).
DevAddr	This parameter is available only in ABP mode, one of the join network parameters.
NwkSkey	This parameter is available only in ABP mode, one of the join network parameters.
AppSkey	This parameter is available only in ABP mode, one of the join network parameters.



## 3.2 Get Device EUI, App EUI and Key

### 3.2.1 Get the parameters via API

(1) Device EUI and Device Code is on the SenseCAP product label.

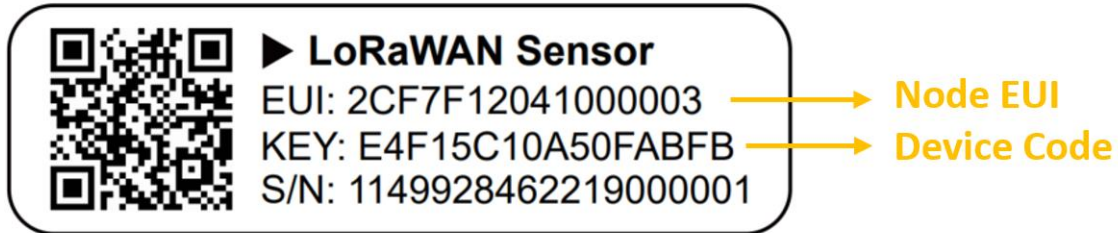

**⚠ Note:**

The “Key” on the label is Device Code, which is not the App Key!

(2) SenseCAP Node’s App EUI and App Key have been flashed into the device by Seeed. Use HTTP API to get App EUI and App Key. You can use a browser (Google Chrome) to launch an HTTP GET request.

**Curl:**

```
https://sensecap.seeed.cc/makerapi/device/view_device_info?nodeEui=2CF7F12014700297&deviceCode=34BF25920A4EFBF4
```

In the API, replace the Device EUI and device Code with your own Device EUI and Device Code respectively. And you will get the following response:

dev_eui	Device EUI	2CF7F12014700297
app_eui	App EUI	8000000000000006
app_key	App Key	6FD0EF47CBC6E00F1921A08C2E94E8E5

```
{
  "code": "0",
  "data": {
    "nodeEui": "2CF7F12014700297",
    "deviceCode": "34BF25920A4EFBF4",
    "lorawanInformation": {
      "dev_eui": "2CF7F12014700297",
      "app_eui": "8000000000000006",
      "app_key": "6FD0EF47CBC6E00F1921A08C2E94E8E5"
    }
  },
  "time": 0.019
}
```





**Note:**

*The SenseCAP LoRaWAN Sensor can modify to EUI, Key, and Frequency.*

*Please refer to the following sections.*

---

### **3.2.1 Get the parameters via SenseCAP Mate App**

Please refer to the [section 5](#).



## 4. LED of Sensor Working Status

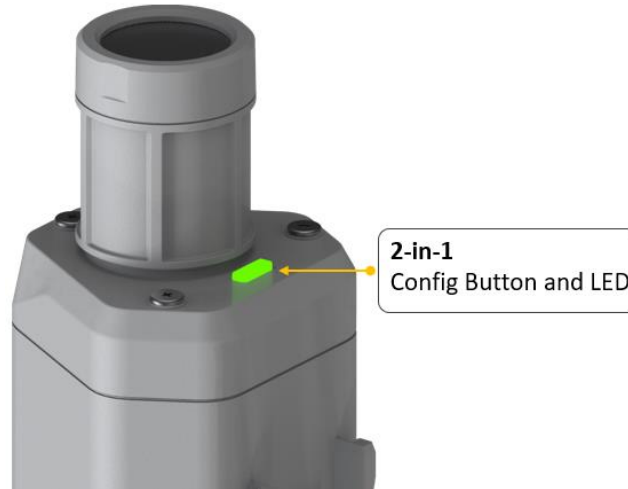

You can refer to the LED indicator for the Sensor Node for its working status. Please see the status explanations in the chart below:

Actions	Description	Green LED Status
First power up, press and hold for 9s	Power on and activate the Bluetooth	LED flashes at 1s frequency
Press once	Reboot device and join LoRa network	<ol style="list-style-type: none"><li>1. The LED will be on for 5 seconds for initialization</li><li>2. Waiting for join network: breathing light flashing</li><li>3. Join network success: LED flashes fast for 2s</li></ol>
Press and hold for 3s	Activate Bluetooth again	<ol style="list-style-type: none"><li>1. Waiting for Bluetooth connection: LED flashes at 1s frequency</li><li>2. Enter configuration mode after Bluetooth</li></ol>



		connection is successful: LED flashes at 3s frequency
Press and hold for 9s	Power off	In the 3rd seconds will start flashing at 1s frequency, until the light is steady on, release the button, the light will go out

---

 **Note:**

*After power off, you need to reconfigure the frequency band. Power off is recommended when not deployed.*

---



## 5. SenseCAP Mate App

### 5.1 Download App

As a tool, SenseCAP Mate App is used to config LoRa parameters, set interval, bind devices to your account and check device basic information.

---

**⚠️ Note:**

*SenseCAP Mate App functions are being iterated in stages:*

*Stage1: Equipment configuration, firmware update. (Done)*

*Stage2: Bind the device to SenseCAP Portal and manage the device. (Developing)*

*Stage3: Data visualization and scene monitoring. (Developing)*

---

- (1) For iOS, please search for “SenseCAP Mate” in the App Store and download it.

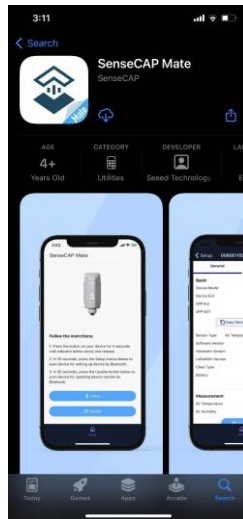

- (2) For Android, please search for “SenseCAP Mate” in the Google Store and download it.

You can also download App from <https://www.pgyer.com/sensecapmate>



## 5.2 How to connect sensor to App

- 1) Press button and hold for **3 seconds**, the LED will flash at 1s frequency.

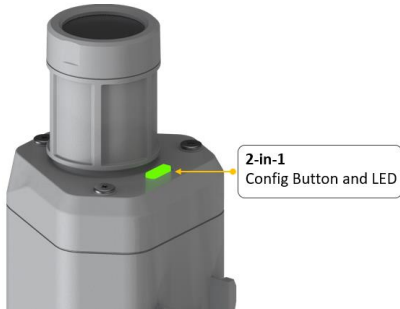

- 2) Please click the "Setup" button to turn on Bluetooth and click "Scan" to start scanning the sensor's Bluetooth.

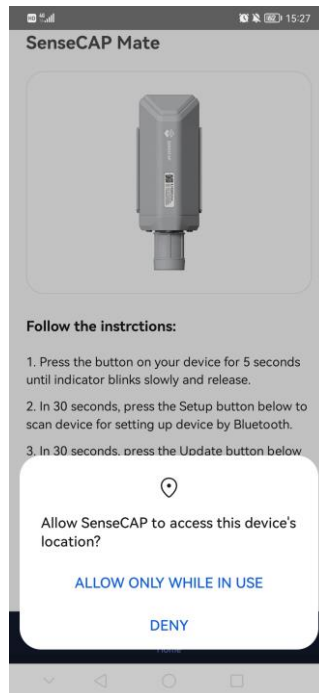

- 3) Select the Sensor by S/N. Then, the basic information of the sensor will be displayed after entering.

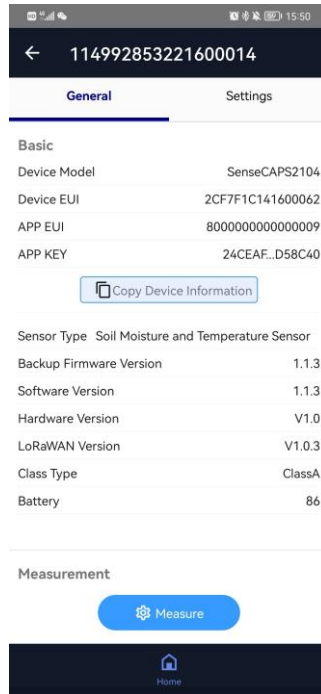
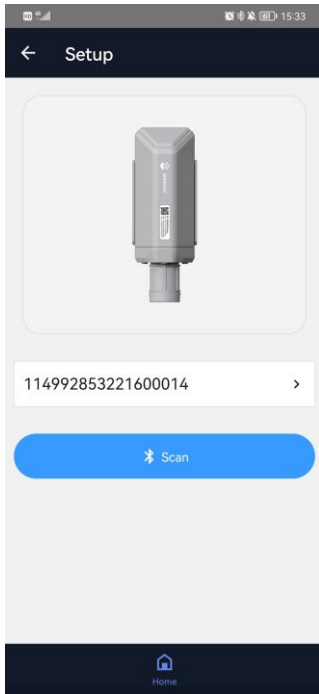

- 4) Enter configuration mode after Bluetooth connection is successful: LED flashes at 3s frequency.



## 5.3 Configure parameters through App

### 5.3.1 Select the Platform and Frequency

S210x Sensors are manufactured to support universal frequency plan from 863MHz ~928MHz in one SKU. That is to say, every single device can support 7 frequency plans.

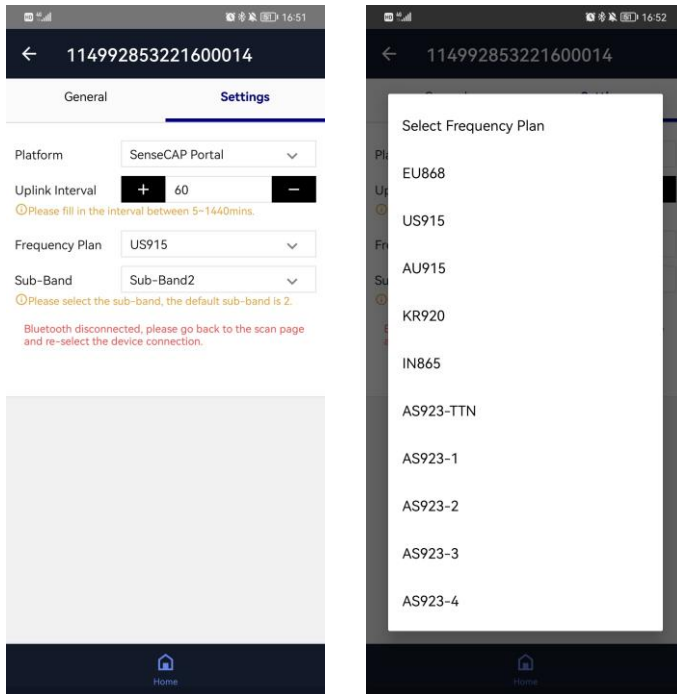

#### 1) SenseCAP Portal:

We provide the SenseCAP Portal to manage devices and data: [sensecap.seeed.cc](https://sensecap.seeed.cc)

When SenseCAP Portal is selected, the device runs in a fixed main frequency and sub-band. You only need to select the main frequency, such as EU868 and US915.

---

#### **Note:**

Now, the device needs to be used with the SenseCAP outdoor gateway (<https://www.seeedstudio.com/LoRaWAN-Gateway-EU868-p-4305.html>) to transmit data to the SenseCAP Portal.

---



SenseCAP Portal supports the following frequency plan:

Frequency	Description
EU868	It must be used with SenseCAP EU868 Gateway ( <a href="https://www.seeedstudio.com/LoRaWAN-Gateway-EU868-p-4305.html">https://www.seeedstudio.com/LoRaWAN-Gateway-EU868-p-4305.html</a> )
US915	It must be used with SenseCAP US915 Gateway ( <a href="https://www.seeedstudio.com/LoRaWAN-Gateway-US915-p-4306.html">https://www.seeedstudio.com/LoRaWAN-Gateway-US915-p-4306.html</a> )
AU915	Need to contact sales.
KR920	Need to contact sales.
IN865	The sensor is supported, but there is no SenseCAP gateway for the frequency band.
AS923-1	Need to contact sales.
AS923-2	Need to contact sales.
AS923-3	The sensor is supported, but there is no SenseCAP gateway for the frequency band.
AS923-4	The sensor is supported, but there is no SenseCAP gateway for the frequency band.

## 2) Other Platform:

When you use Helium, TTN and other LoRaWAN network server, please select Other Platform. At this point, you need to determine the sensor frequency band according to the gateway frequency and sub-band.

S210x Sensors support the following frequency plan:

Frequency	Common Name	Sub-band
EU863-870	EU868	-----
US902-928	US915	Sub band from 1 to 8 (default sub-band 2)
AU915-928	AU915	Sub band from 1 to 8 (default sub-band 2)
KR920-923	KR920	-----
IN865-867	IN865	-----





AS923	AS923-1	-----
	AS923-2	-----
	AS923-3	-----
	AS923-4	-----
RU864-867	RU864	-----

**⚠ Note:**

Different countries and LoRaWAN network servers use different frequency plans. For Helium network, please refer to:

<https://docs.helium.com/lorawan-on-helium/frequency-plans>

For The Things Network, please refer to:

<https://www.thethingsnetwork.org/docs/lorawan/frequency-plans/>

### 5.3.2 Set the Interval

The working mode of device: wake up the device every interval and collect measurement values and upload them through LoRa. For example, the device collects and uploads data every 60 minutes by default.

Parameter	Type
Uplink Interval	Unit: minutes, number from 1 to 1440.

Uplink Interval  + -

ⓘ The interval is 1~1440mins.

### 5.3.3 Set the EUI and Key

The device uses OTAA to join the LoRaWAN network by default. So, it can set the device EUI and App EUI.

Parameter	Type
Device EUI	16 bits, hexadecimal from 0 ~ F



App EUI	16 bits, hexadecimal from 0 ~ F
App Key	32 bits, hexadecimal from 0 ~ F

← 114992853221600014

General **Settings**

Platform Other Platform ▾

Device EUI 2CF7F1C141600062  
ⓘ Only hexadecimal numbers of 0-F with a maximum of 16 digits are allowed to be filled in.

Uplink Interval + 60 -  
ⓘ The interval is 1~1440mins.

APP EUI 8000000000000009  
ⓘ Only hexadecimal numbers of 0-F with a maximum of 16 digits are allowed to be filled in.

### 5.3.4 Set the Packet Policy

The sensor uplink packet strategy has three modes.

Packet Policy 2C+1N ▾

Parameter	Description
2C+1N (default)	2C+1N (2 confirm packets and 1 none-confirm) is the best strategy, the mode can minimize the packet loss rate, however the device will consume the most data packet in TTN, or date credits in Helium network.
1C	1C (1 confirm) the device will sleep after get 1 received confirm packet from server.
1N	1N (1 none-confirm) the device only send packet and then start to sleep, no matter the server received the data or not.



### 5.3.5 Set the Activation Type

The sensor supports two network access modes, OTAA by default.

Parameter	Description
OTAA (default)	Over The Air Activation, it joins the network through Device EUI, App EUI, and App Key.
ABP	Activation By Personalization, it joins the network through DevAddr, NwkSkey, and AppSkey.

When using ABP mode, you need to configure the following information:

Parameter	Description
DevAddr	32 bits, hexadecimal from 0 ~ F
NwkSkey	32 bits, hexadecimal from 0 ~ F
AppSkey	8 bits, hexadecimal from 0 ~ F

Activation Type

Nwk Skey

*Only hexadecimal numbers of 0-F with a maximum of 32 digits are allowed to be filled in.*

APP Skey

*Only hexadecimal numbers of 0-F with a maximum of 32 digits are allowed to be filled in.*

Dev Addr

*Only hexadecimal numbers of 0-F with a maximum of 8 digits are allowed to be filled in.*

**Note:**

*The factory defaults to a fixed value.*



### 5.3.6 Restore Factory Setting

When we make a mistake or want to reset everything, we can click the button. The device will be restored to the factory's default configuration.





## 6. Connect to the SenseCAP Portal

### 6.1 Quick Start

Follow this process to quickly use the sensor, see the following section for details.

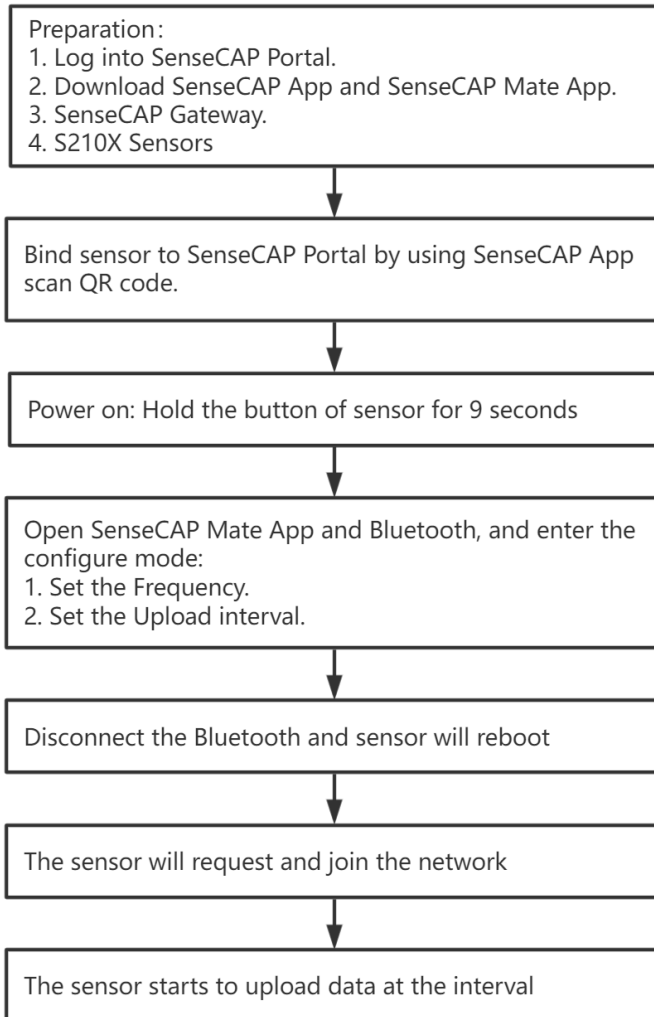



## 6.2 SenseCAP Portal

The main function of the SenseCAP Portal is to manage SenseCAP devices and to store data. It is built on Azure, a secure and reliable cloud service from Microsoft. You can apply for an account and bind all devices to this account. SenseCAP provides the web portal and API. The web portal includes Dashboard, Device Management, Data Management, and Access Key Management, while API is open to users for further development.

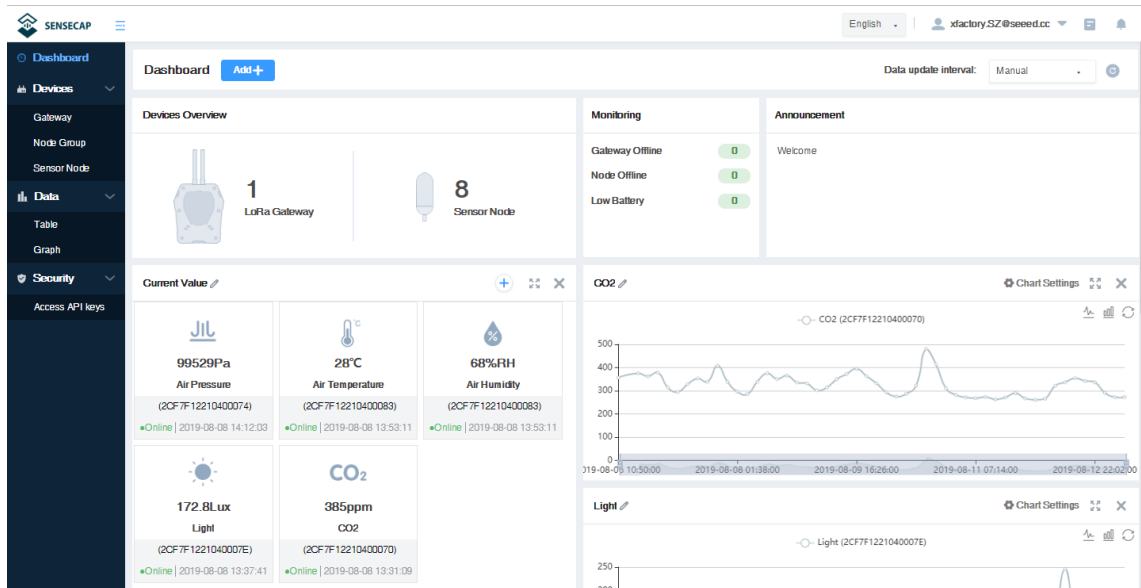

### 6.2.1 Create a New Account

Portal Website: <http://sensecap.seeed.cc>

- 1) Select register account, enter email information and click "register", the registered email will be sent to the user's mailbox.
- 2) Open the "SenseCAP..."Email, click the jump link, fill in the relevant information, and complete the registration.
- 3) Return to the login interface and complete the login.

**Note:**

*If you can't find the email, it may be automatically identified as "spam" and put in the "trash can".*



## 6.2.2 Other Functions

- **Dashboard:** Including Device Overview, Announcement, Scene Data, and Data Chart, etc.
- **Device Management:** Manage SenseCAP devices.
- **Data Management:** Manage data, including Data Table and Graph section, providing methods to search for data.
- **Subaccount System:** Register subaccounts with different permissions.
- **Access Key Management:** Manage Access Key (to access API service), including Key Create, Key Update, and Key Check.



**Note:**

**SenseCAP Portal User Guide:** <https://sensecap-docs.seeed.cc/quickstart.html>

---

## 6.2.3 API Instruction

SenseCAP API is for users to manage IoT devices and data. It combines 3 types of API methods: HTTP protocol, MQTT protocol, and WebSocket protocol.

- With HTTP API, users can manage LoRa devices, to get raw data or historical data.
- With MQTT API, users can subscribe to the sensor's real-time measurement data through the MQTT protocol.
- With WebSocket API, users can get real-time measurement data of sensors through WebSocket protocol.

Please refer to this link for API User Guide: <https://sensecap-docs.seeed.cc/>

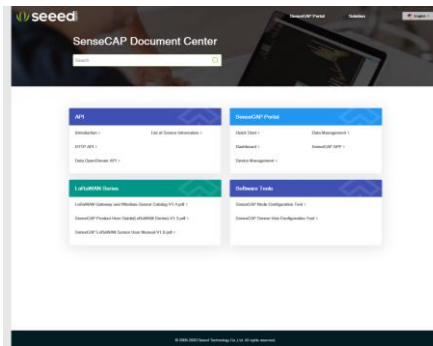



## 6.3 Preparation

### 6.3.1 App

We need to use two apps:

- SenseCAP Mate App: Configuration tool for sensor.
- SenseCAP App: Management device tool for use with SenseCAP Portal.

#### SenseCAP Mate App

Please refer to [section 5](#) for using.

SenseCAP App is used to bind devices to your account and check device information.

- For iOS, please search for “SenseCAP” in the App Store and download it.
- For Android, you can download the App from <http://sensecap-app-download.seeed.cn>

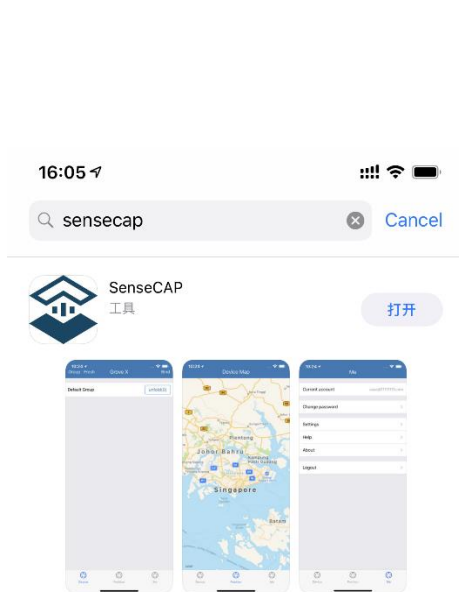

Download Android APP

Or scan the following QR code







### 6.3.2 SenseCAP Gateway

Now, the device needs to be used with the SenseCAP Outdoor Gateway (<https://www.seeedstudio.com/LoRaWAN-Gateway-EU868-p-4305.html>) to transmit data to the SenseCAP Portal.

- 1) Setup the Gateway, connect to power cable and Internet.
- 2) Bind the gateway to SenseCAP Portal.
- 3) Ensure the gateway indicator is steady on.



- 4) Ensure the gateway is displayed online on the portal.





## 6.4 Bind Sensor to SenseCAP Portal

Please open SenseCAP App.

### 6.4.1 Scan QR Code

1) Click “Bind” on the upper-right corner to enter the device binding page.



2) Scan the QR code on the device to bind the device to your account. If you do not set it to a designated group, the device will be put into the “default” group.



### 6.4.2 Manually fill in the EUI

If the QR code sticker is damaged, you can manually fill in the EUI of the device to bind the device to your account. Please make sure you put in the EUI in the format suggested by the system and then click “confirm”.



China Mobile 4G 100% 2:30 PM

< Entering Device

First SN Line  (6/16)

Second SN Line  (0/16)

1	2	3
4	5	6
7	8	9
A	B	C
D	E	F
Clear	0	Delete

Confirm



## 6.5 Setup the Sensor

- 1) Open the SenseCAP Mate App
- 2) Press button and hold for 9 seconds, the LED will flash at 1s frequency.

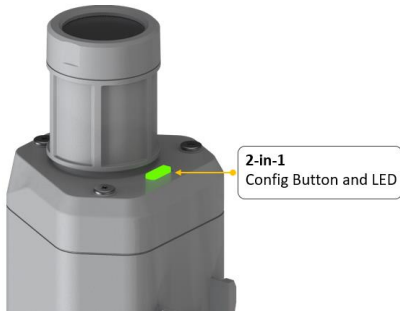

- 3) Please click the “Setup” button to turn on Bluetooth and click “Scan” to start scanning the sensor's Bluetooth.

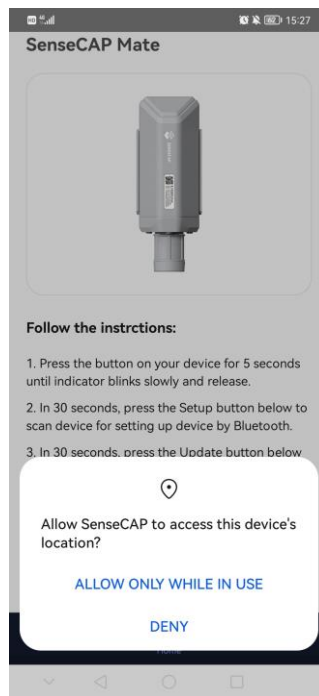

- 4) Select the Sensor by S/N (label). Then, the basic information of the sensor will be displayed after entering.

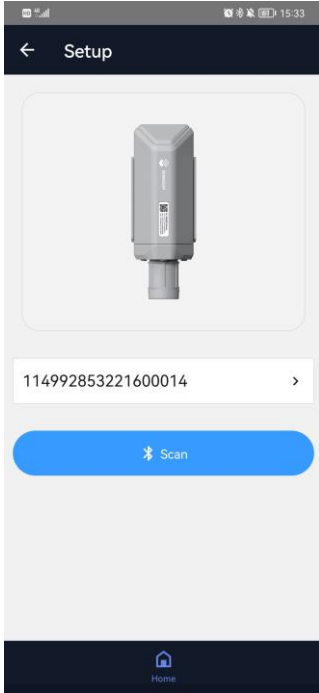



## 6.6 Set Frequency of Sensor via SenseCAP Mate App

Set the corresponding frequency band based on the frequency band of the gateway.

Please refer to [section 5](#) for detail.

- 1) Click the “Setting” and select the platform is “SenseCAP Portal”.

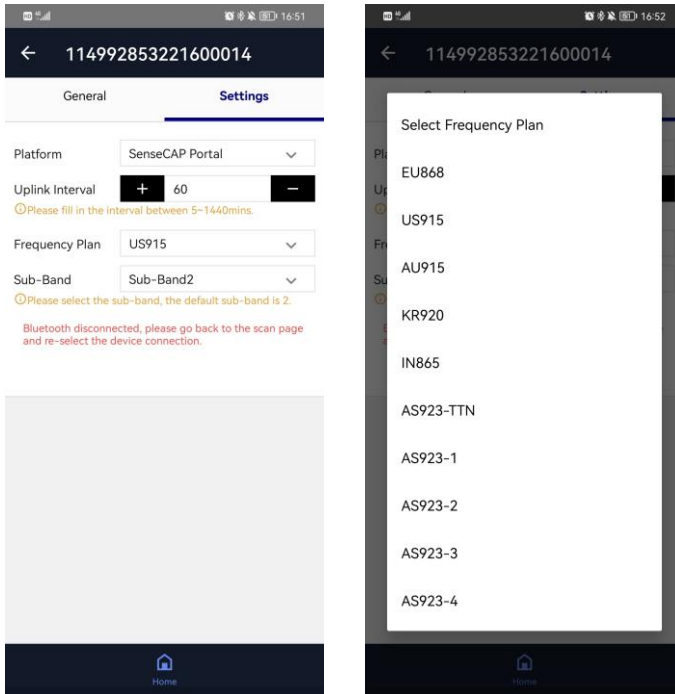

- 2) Select the Frequency Plan, if the gateway is US915, set the sensor to US915.

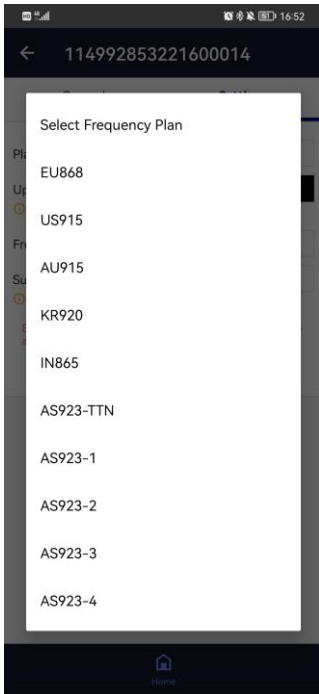

3) Click the “Send” button, send the setting to the sensor for it to take effect.



4) Click the “Home” button, the App will disconnect the Bluetooth connection.

Then, the sensor will reboot.

5) When the device is disconnected from Bluetooth, the LED lights up for 5 seconds and then flashes as a breathing light.

6) After joining the network successfully, LED flashes fast for 2s.



## 6.7 Check Data on SenseCAP Portal

On the SenseCAP App or the website <http://sensecap.seeed.cc/>, you can check the device online status and the latest data. In the list for each Sensor, you can check its online status and the time of its last data upload.

The screenshot shows the SenseCAP portal interface. The left sidebar contains navigation options: Dashboard, Devices (Gateway, Node Group, Sensor Node), Data (Table, Graph), and Security (Access API keys). The main content area is titled 'Devices / Sensor Node' and includes search filters for LoRa and NB-IoT, EUI, Device Group, Online Status, and Registration Time. Below the filters is a table with 4 search results. Two columns, 'Sensor Count' and 'Online Status', are highlighted with red boxes in the original image.

NO.	EUI	Device Name	Sensor Count	Device Group	Online Status	Operation	Last Message Time
1	2CF7E12210400070	CO2 Sensor	1	station-1	Online	<a href="#">Move</a>	2019-11-15 10:28:16
2	2CF7E12210400074	Barometric Pressure Sensor	1	station-1	Online	<a href="#">Move</a>	2019-11-15 10:09:27
3	2CF7E1221040007E	Light Intensity Sensor	1	station-1	Online	<a href="#">Move</a>	2019-11-15 09:43:47
4	2CF7E12210400083	Air Temperature and Humidity Sensor	1	station-1	Online	<a href="#">Move</a>	2019-11-15 10:02:47





## 7. Connect to Helium Network

### 7.1 Register

Please go to <https://console.helium.com/> , and register your account.

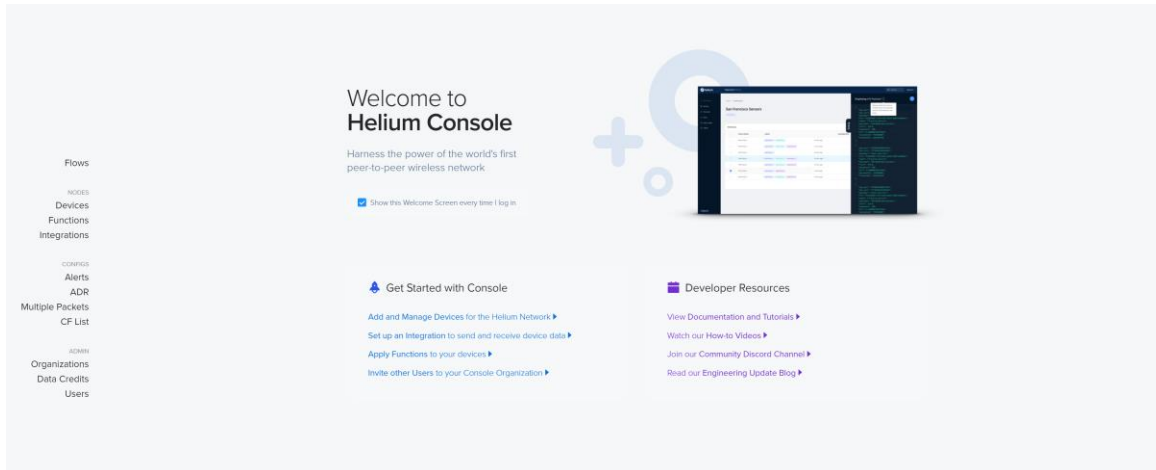



## 7.2 Add New Device

1) Click “Devices” → “Add New Device”

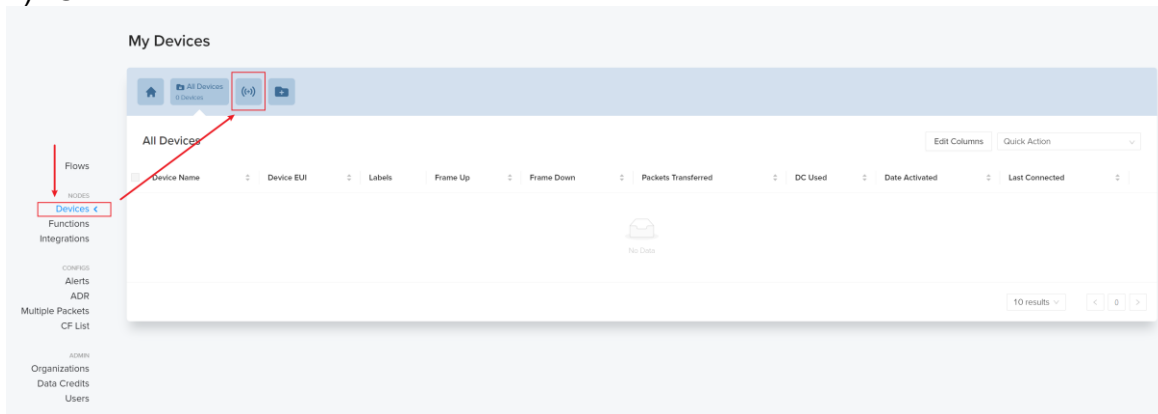

2) Enter the Device EUI, App EUI, App Key: please refer to **Section 1.1** for details.

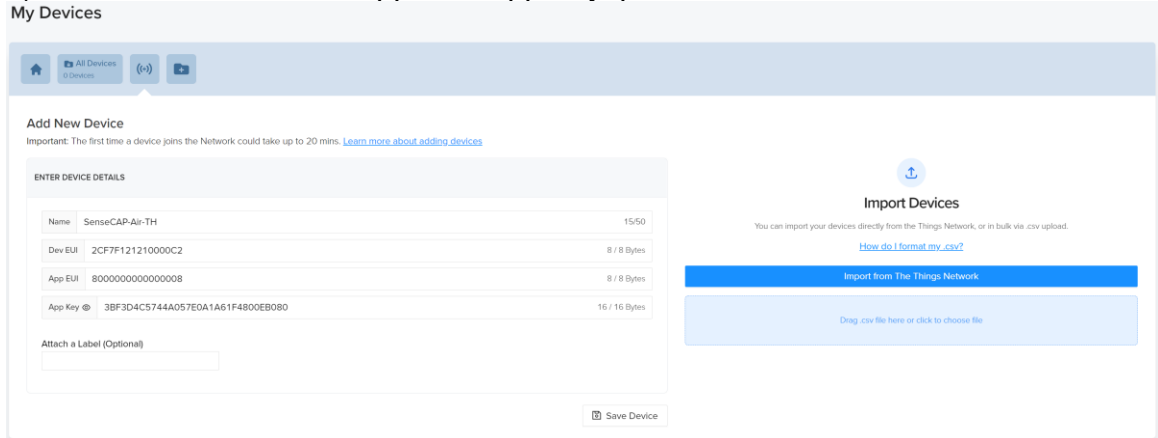

3) Save device.

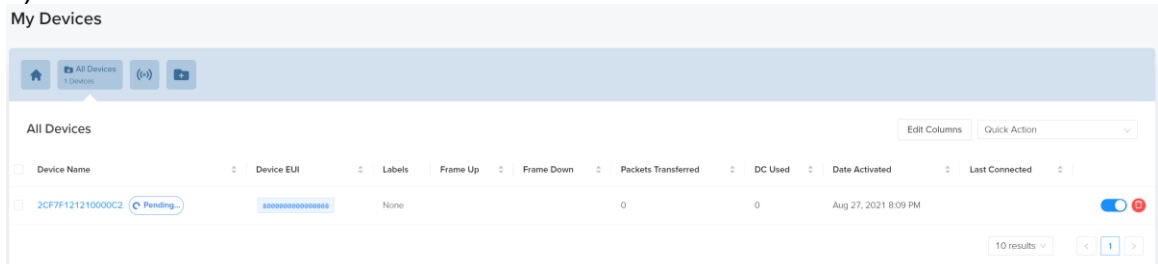

4) Add a new label, then add the label to a device.



**My Devices**

All Devices 1 Devices (+) **+**

ENTER LABEL DETAILS

SenseCAP-TH-Node 16/50

Label names must be unique

Save Label

**My Devices**

All Devices 1 Devices (+) **SenseCAP-TH-Node 0 Devices**

SenseCAP-TH-Node

Exit Columns Label Settings Quick Action

Add this Label to a Device

Pause Packet Transfer for Selected Devices

Remove Selected Devices from Label

Delete Selected Devices

Delete This Label

Device Name	Device EUI	Labels	Frame Up	Frame Down	Packets Transferred	DC Used	Date Activated
No Data							

Which Devices do you want to add this Label to?

Devices

SELECT ALL DEVICES

Labels

Search here

2CF7F12121000C2

Cancel Add Label to Devices

**My Devices**

All Devices 1 Devices (+) **SenseCAP-TH-Node 1 Devices**

SenseCAP-TH-Node

Edit Columns Label Settings Quick Action

Device Name	Device EUI	Labels	Frame Up	Frame Down	Packets Transferred	DC Used	Date Activated	List Connected
<input type="checkbox"/> 2CF7F12121000C2	8000000000000000	SenseCAP-TH-Node			0	0	Aug 27, 2021 8:09 PM	<input checked="" type="checkbox"/>



### 7.3 Check the data on Helium

1) Enter device details page and find the REAL TIME PACKETS.

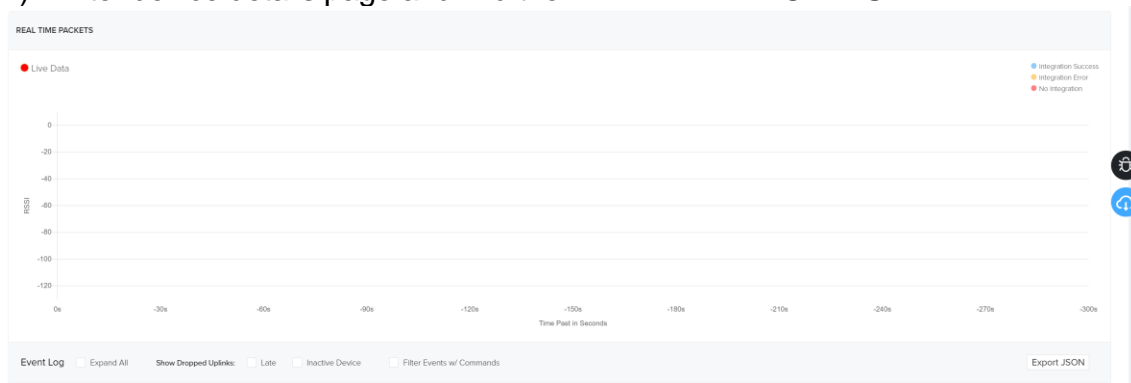

2) Power on the Sensor, it will display raw data.

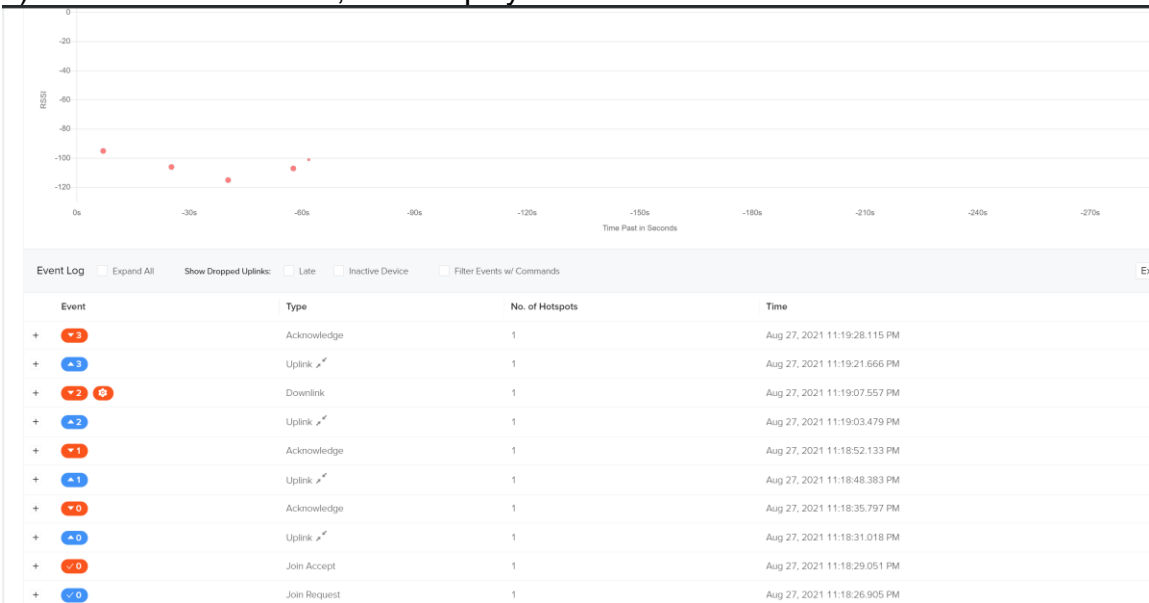



## 7.4 Upload Data from Helium to Datacake

### 7.4.1 Create a Datacake Account

1) Create a new account, website: <https://datacake.co/>

**DATA CAKE**

### Create an Account

First Name: e.g. John      Last Name: e.g. Doe

Email: e.g. john.doe@example.com

Name of your first Workspace: e.g. the name of your company or your name

Password:      Confirm Password:

Passwords must have a minimum of 8 characters, including at least one uppercase letter, one lowercase letter, one number and one special character (@\$%\*#7&).

I agree to the Terms of Use and Privacy Policy. I also agree to receive relevant information (such as Software Updates, maintenance, etc.) and my account via email.

**Create Account**

Already have a Datacake Account? [Sign In](#)

2) Click the “Edit Profile” → “API” → Get API token.

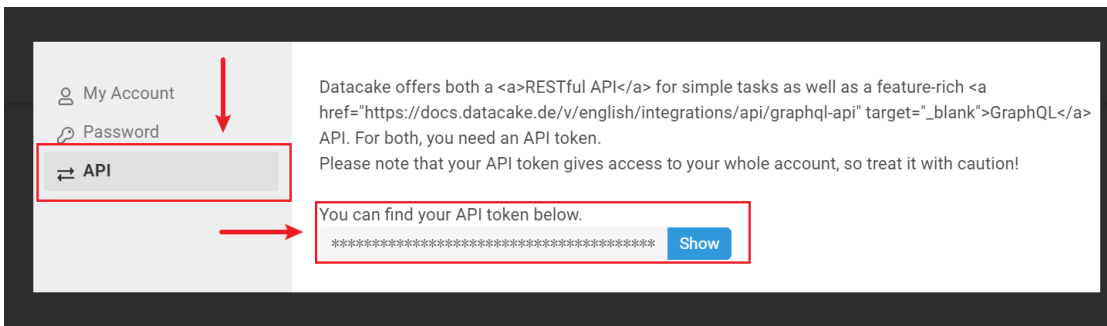
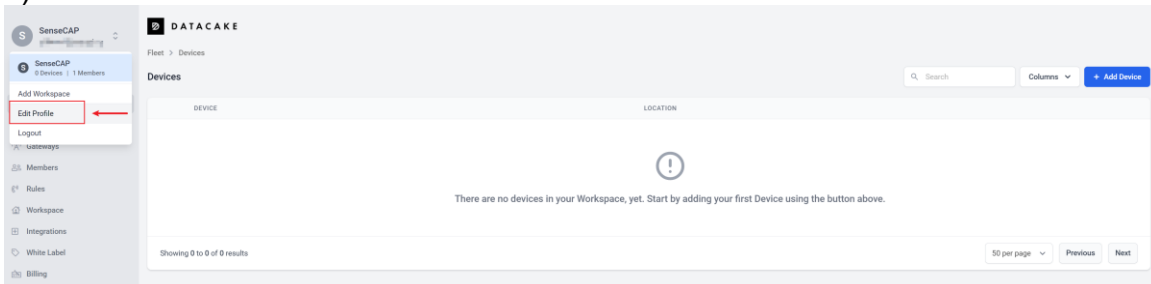

### 7.4.2 Add New Integration on Helium Console

1) Click “Integrations” → “Add New Integration” → “Datacake”.

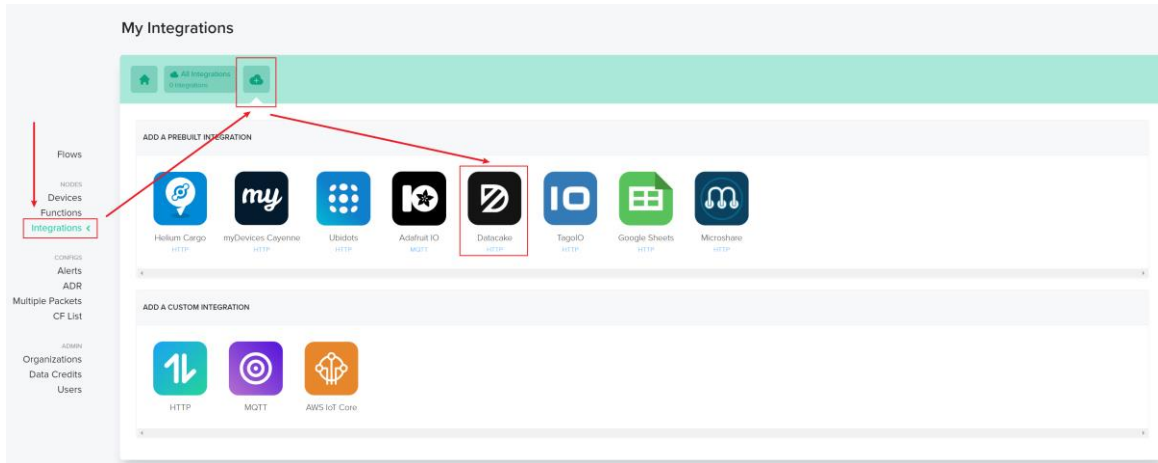

2) Enter Datalog Token (Refer to [the section](#)) and name your integration.

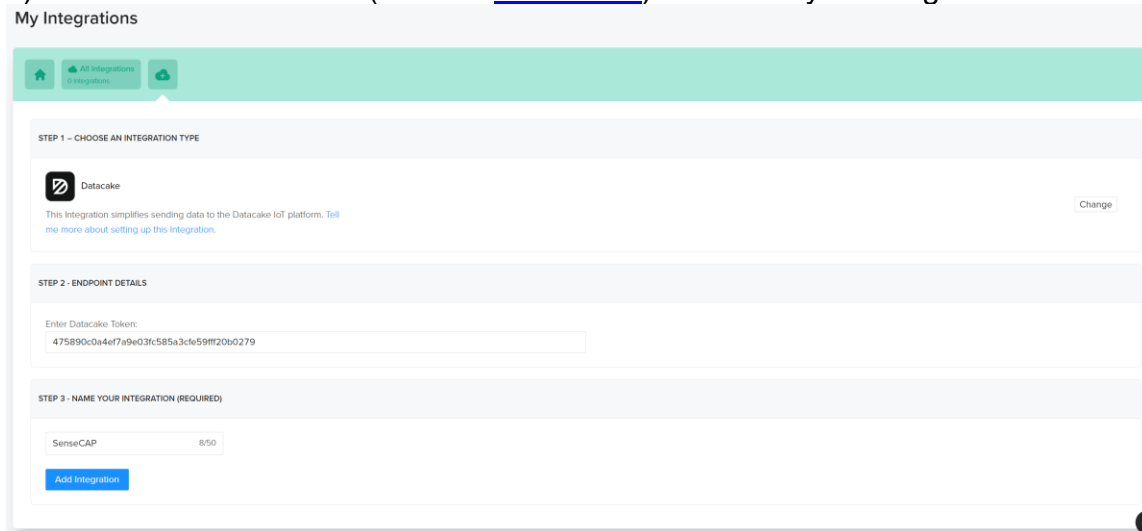

### 7.4.3 Configure the Flows on Helium

1) Click "Flows".

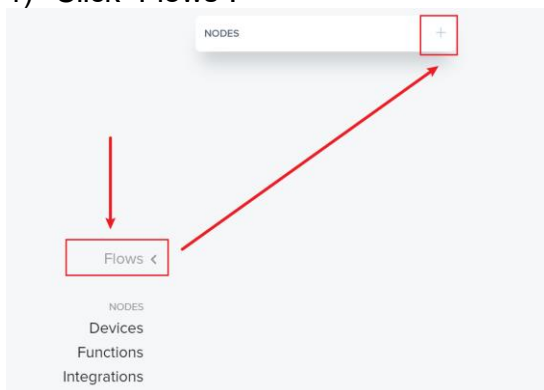

2) Drag the Label into a blank place.

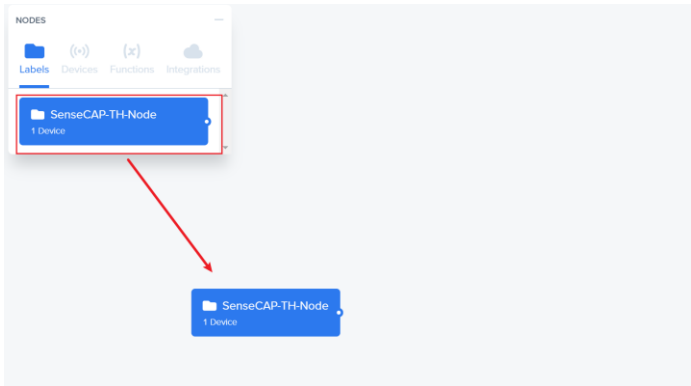

3) Drag the Integration in to a blank place.

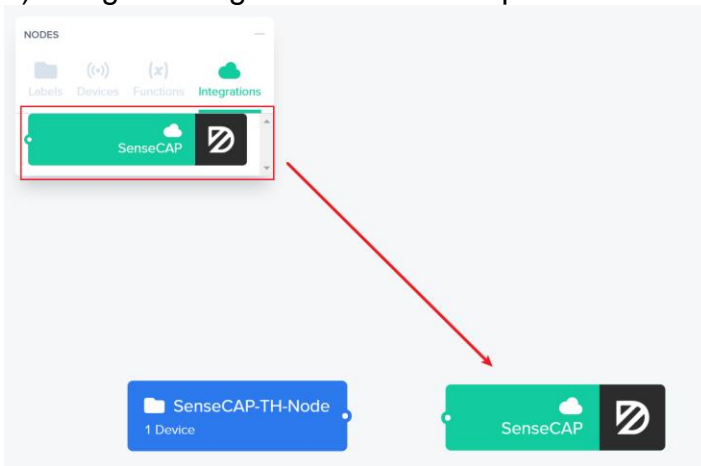

4) Connect the two blocks.

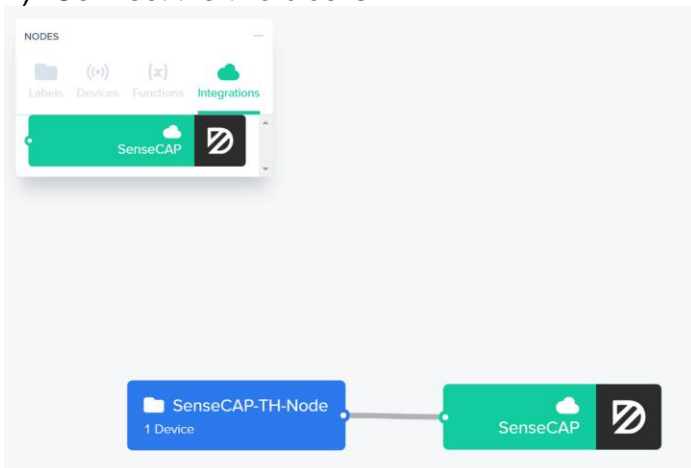

5) Save Changes.

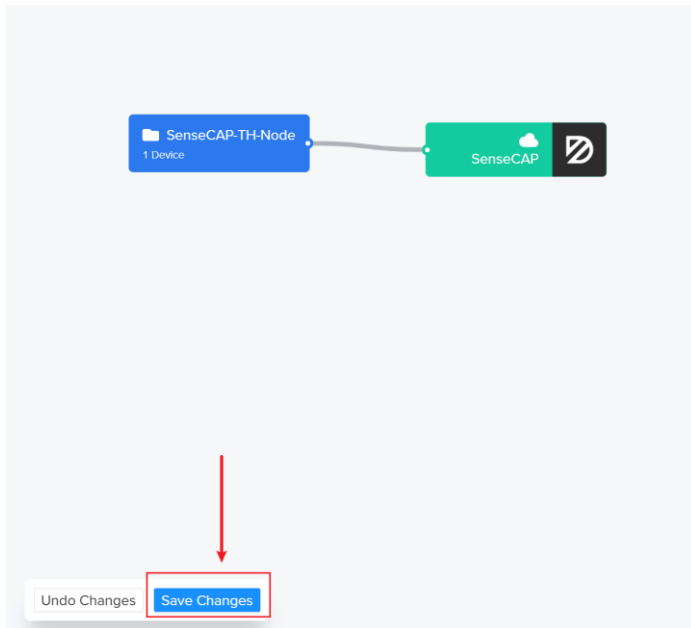

### 7.4.4 Add the Sensor on Datacake

1) Return Datacake Dashboard, and click “Device” → “Add Device”

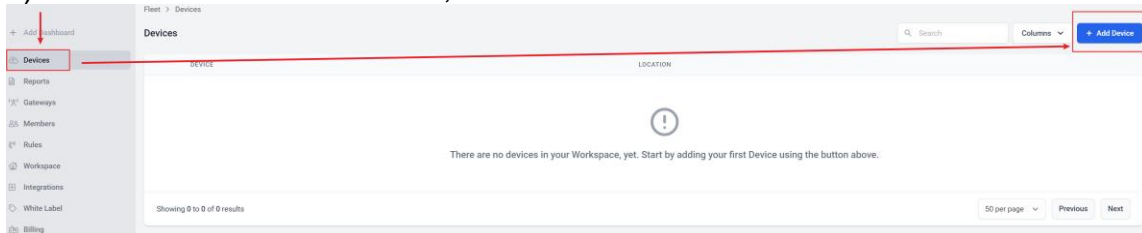

2) Search “Seed”, You can select some sensors directly.





**Add Device**

LoRaWAN PARTICLE API D Zero D Zero LTE PINCODE

STEP 1 Product STEP 2 Network Server STEP 3 Devices STEP 4 Plan

**Datacake Product**

You can add devices to an existing product on Datacake, create a new empty product or start with one of the templates. Products allow you to share the same configuration (fields, dashboard and more) between devices.

**New Product from template**  
Create new product from a template

**Existing Product**  
Add devices to an existing product

**New Product**  
Create new empty product

**Device Template**

Datacake supports LoRaWAN devices from different manufacturers out of the box without complex configuration and setup.

Seed All Manufacturers

- Seeed Studio SenseCAP Barometric Pressure Sensor Seeed Studio
- Seeed Studio SenseCAP CO2 Sensor Seeed Studio
- Seeed Studio SenseCAP Generic Preset Seeed Studio
- Seeed Studio SenseCAP Temperature Humidity Sensor

3) Select the Sensor Template.



Seed Studio SenseCAP

Barometric Pressure Sensor   
Seed Studio

Seed Studio SenseCAP CO2

Sensor   
Seed Studio

Seed Studio SenseCAP Generic







Preset   
Seed Studio

Seed Studio SenseCAP  
Temperature Humidity Sensor   
Seed Studio

[Next](#)

4) Select "Helium".

Add Device ✕

     

LoRaWAN    Particle    API    D Zero    D Zero LTE    PINCODE

STEP 1 Product    STEP 2 Network Server    STEP 3 Devices    STEP 4 Plan

**Network Server**

Please choose the LoRaWAN Network Server that your devices are connected to.

 The Things Stack V3  
TTN V3 / Things Industries    Uplinks    Downlinks

 The Things Network V2  
The old Things Network    Uplinks    Downlinks

 helium Helium    Uplinks    Downlinks

 LORIoT    Uplinks    Downlinks

 kerlink Kerlink Wanasy    Uplinks

Showing 1 to 5 of 8 results    [Previous](#)    [Next](#)

[Back](#)    [Next](#)

5) Enter your Device EUI and Name.



**Add Device**

LoRaWAN PARTICLE API D Zero D Zero LTE PINCODE

STEP 1 Product    STEP 2 Network Server    STEP 3 Devices    STEP 4 Plan

**Add Devices**

Enter one or more LoRaWAN Device EUIs and the names they will have on Datacake.

DEVEUI	NAME
2C F7 F1 21 21 10 01 2 8 bytes	SenseCAP-Air TH

+ Add another device

Back Next

6) Select your Plan and add device.

**Add Device**

LoRaWAN PARTICLE API D Zero D Zero LTE PINCODE

STEP 1 Product    STEP 2 Network Server    STEP 3 Devices    STEP 4 Plan

Plan	Price	Retention	Datapoints / day	Max. per workspace	Cancel
Free	0.00€ / month	7 days data retention	500 datapoints / day	max. 2 per workspace	Cancel any time
Light	1.00€ / month	1 month data retention	1,000 datapoints / day		Cancel any time
Standard	3.00€ / month	3 months data retention	2,500 datapoints / day		Cancel any time
Plus	5.00€ / month	12 months data retention	7,500 datapoints / day		Cancel any time

Have a code?  Apply

Back Add 1 device

### 7.4.5 Check Data from Datacake

1) Click Debug button, it will display debug log.



## SenseCAP-Air-TH

Serial Number  
2CF7F121211000DE

Last update  
Never

- Dashboard
- History
- Downlinks
- Configuration
- Debug**
- Rules
- Permissions

### Debug Log

The Debug Log shows the last up to 100 debug messages.

Time	Title	Details
Sat, Aug 28, 2021 12:57 AM	Recorded measurements from payload decoder	Decoder returned: [] Log: null Recorded measurements: Decoder execution time: 26.178312ms
Sat, Aug 28, 2021 12:57 AM	Received webhook data from helium	Raw webhook: b'({"app_eui":"800800000000008","dev_eui":"2CF7F121211000DE","devaddr":"AC030048","downlink_url":"https://console.helium.com/api/v1/down/598b5477-e036-4751-8377-95620274/0Vs1Lzs2U59McunyjE1pKwIBu9p0e5/73178a3b-fdfe-4796-95c0-85"})
Sat, Aug 28, 2021 12:56 AM	Recorded measurements from payload decoder	Decoder returned: [] Log: null

## SenseCAP-Air-TH

Serial Number  
2CF7F121211000DE

Last update  
Never

- Dashboard
- History
- Downlinks
- Configuration
- Debug**
- Rules
- Permissions

### Debug Log

The Debug Log shows the last up to 100 debug messages.

Time	Title	Details
Sat, Aug 28, 2021 1:01 AM	Recorded measurements from payload decoder	Decoder returned: { "field": "HUMIDITY", "value": 63.4 } Log: null Recorded measurements: HUMIDITY = 63.4 (timestamp: auto) Decoder execution time: 2.7309ms
Sat, Aug 28, 2021 1:01 AM	Received webhook data from helium	Raw webhook: b'({"app_eui":"800800000000008","dev_eui":"2CF7F121211000DE","devaddr":"AC030048","downlink_url":"https://console.helium.com/api/v1/down/598b5477-e036-4751-8295-837795620274/0Vs1Lzs2U59McunyjE1pKwIBu9p0e5/73178a3b-fdfe-4796-95c0-85"})
Sat, Aug 28, 2021 1:01 AM	Recorded measurements from payload decoder	Decoder returned: { "field": "TEMPERATURE", "value": 27.4 } Log: null

Activate Windows  
Go to Settings to activate Windows.







## 8. Connect to The Things Network

The Things Network website: <https://www.thethingsnetwork.org>

The Things Industries login: <https://accounts.thethingsindustries.com/login>

TTN Quick Start: <https://www.thethingsnetwork.org/docs/quick-start/>



## 8.1 Preparation

### 8.1.1 Gateway Registration on TTN

Create a Gateway on the TTN console.

The screenshot shows the 'Add gateway' form in the TTN console. The navigation bar includes 'THE THINGS STACK' logo and menu items for 'Overview', 'Applications', 'Gateways', and 'Organizations'. The form fields are as follows:

- Owner:** A dropdown menu with 'sensecap' selected.
- Gateway ID:** A text input field containing 'my-new-gateway'.
- Gateway EUI:** A text input field containing 'Gateway EUI'.
- Gateway Name:** A text input field containing 'My new gateway'.
- Gateway description:** A text area containing 'Description for my new gateway'. Below the text area is the text: 'Optional gateway description; can also be used to save notes about the gateway'.
- Gateway Server address:** A text input field containing 'sensecap-stts-sg-1.seeed.cc'. Below the field is the text: 'The address of the Gateway Server to connect to'.

### 8.1.2 Create the Application

Create an application on your TTN console.

The screenshot shows the 'Add application' form in the TTN console. The navigation bar includes 'THE THINGS STACK' logo and menu items for 'Overview', 'Applications', 'Gateways', and 'Organizations'. The form fields are as follows:

- Owner:** A dropdown menu with 'sensecap' selected.
- Application ID:** A text input field containing 'my-new-application'.
- Application name:** A text input field containing 'My new application'.
- Description:** A text area containing 'Description for my new application'. Below the text area is the text: 'Optional application description; can also be used to save notes about the application'.
- Linking:** A checkbox labeled 'Link new application to Network Server automatically' which is checked.
- Network Server address:** An empty text input field. Below the field is the text: 'Leave empty to link to the Network Server in the same cluster'.

At the bottom of the form is a blue button labeled 'Create application'.



## 8.2 Add Sensor to TTN Console

1) Application → End Devices → Add end device

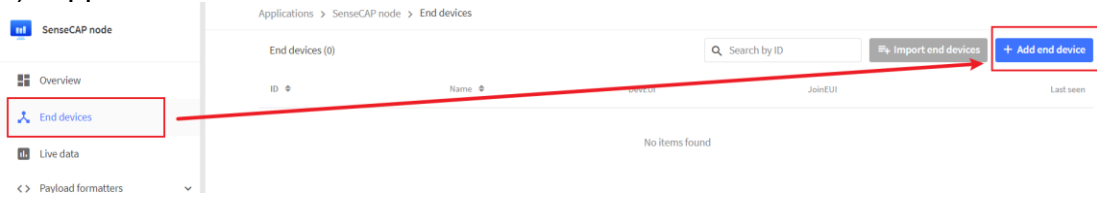

2) Select the end device

- ① Brand: SenseCAP
- ② Model: Select your sensor. (If not, use manual add)
- ③ Hardware / Firmware Version: Usually choose the latest
- ④ Device ID: Enter a unique name.

Applications > SenseCAP node > End devices > Register from The LoRaWAN Device Repository

### Register end device

[From The LoRaWAN Device Repository](#) Manually

1. Select the end device

Brand ⓘ *	Model ⓘ *	Hardware Ver. ⓘ *	Firmware Ver. ⓘ *	Profile (Region) *
SenseCAP	SenseCAP Wireless Air T...	2.0	3.4	EU_863_870

①



②

**SenseCAP Wireless Air Temperature and Humidity Sensor - LoRaWAN**  
MAC V1.0.2, PHY V1.0.2 REV B, Over the air activation (OTAA), Class A

It measures temperature and humidity in the atmosphere. It's designed with a 2-in-1 sensor, a custom battery, and an industry-grade enclosure, optimized for outdoor use cases that need reliable data collection for years.

③

[Product website](#)

④





## 2. Enter registration data

Frequency plan <sup>?</sup> \* ⑤

Europe 863-870 MHz (SF9 for RX2 - recommended) | v

AppEUI <sup>?</sup> \* ⑥

80 00 00 00 00 00 00 09 00

DevEUI <sup>?</sup> \*

2C F7 F1 20 25 20 00 BB

AppKey <sup>?</sup> \*

54 7E F3 ED 34 3B DB F3 2A 51 5A BF 4B A4 F8 3D | ↻

End device ID <sup>?</sup> \*

2cf7f120252000bb

After registration

View registered end device

Register another end device of this type

[Register end device](#)

⑤ Frequency plan: Get it from SenseCAP Mate App.

⑥ Device EUI、 App EUI、 App Key: Get it from SenseCAP Mate App.

⑦ Register end device.



### 8.3 Check Data on TTN Console

On the Data page, data package is uploaded. For the format of the payload, refer to the section of Payload Decoding.

2cf7f120252000bb  
ID: 2cf7f120252000bb  
Last seen info unavailable 3 2 Created 2 hours ago

Overview Live data Messaging Location Payload formatters Claiming General settings

Data preview Verbose stream Pause Clear

18:57:43 Forward uplink data message Payload: { "iri": 0, messages: [...], payload: "01060000000002F87", valid: true } 81 06 00 00 00 00 2F 87 FFW: 2 SNR: 12 RSSI: -42 Bandwidth: 125000

18:57:12 Forward uplink data message Payload: { "iri": 0, messages: [...], payload: "0000000403000200079064A005001810901810001010200F0200150103003081F7C0504000A0C1310101000000000010", valid: true } 00 00 00 04 03 00 02 00 07 00 64 00 05 00 01 01 00 01

18:56:46 Accept join-request

18:56:34 Update end device [ "root\_keys\_app\_key\_key" ]

18:56:14 Join-request to cluster-local Join Srv. - NIC mismatch

Applications > sensecap-node > Devices > th-sensor > Data

Overview Data Settings

#### APPLICATION DATA

pause clear

Filters: uplink downlink activation ack error

time	counter	port		payload
▲ 19:25:48	4	2	retry confirmed	01 01 10 90 65 00 00 01 02 10 78 E6 00 00 92 AF
▼ 19:25:47		0		
▲ 19:25:47	4	2	confirmed	01 01 10 90 65 00 00 01 02 10 78 E6 00 00 92 AF
▲ 19:25:25	3	2		01 06 00 00 00 00 00 2F 87
▼ 19:25:05		0		
▲ 19:25:04	2	2	confirmed	01 06 00 00 00 00 00 2F 87
▼ 19:24:48		0		
▲ 19:24:47	1	2	confirmed	01 06 00 00 00 00 00 2F 87
▼ 19:24:30		0		
▲ 19:24:29	0	2	confirmed	00 00 00 03 03 00 02 00 07 00 4A 00 3C 00 01 01 00 00 01 00 01 01 02 00 99 00 30 12 01 03 00
⚡ 19:24:19				dev addr: 26 01 27 DB app eui: 80 00 00 00 00 00 06 dev eui: 2C F7 F1 20 14 70 02 97



## 9. Payload Decoder

### 9.1 Decoder Code

TTN payload decoding script for SenseCAP LoRaWAN:

<https://github.com/Seed-Solution/TTN-Payload-Decoder/>

APPLICATION DATA || pause 🗑 clear

Filters uplink downlink activation ack error

time	counter	port	
▼ 11:19:12		0	
▲ 11:19:16	5	2	confirmed payload: 01 01 10 B0 68 00 00 01 02 10 88 F4 00 00 8C FF <span>Measurement Data packets</span>
▼ 11:18:58		0	
▲ 11:19:02	4	2	confirmed payload: 00 19 00 58 68 43 00 00 00AB 5E
▼ 11:18:42		0	<span>Initial Packets</span>
▲ 11:18:46	3	2	confirmed payload: 01 06 00 00 00 00 00 2F 87
▼ 11:18:28		0	
▲ 11:18:32	2	2	confirmed payload: 00 00 00 01 01 00 01 00 07 00 64 00 05 00 01 01 00 01 01 00 01 01 02 00 54 00 00 15 01 03 00 30
▼ 11:18:15		0	
▲ 11:18:19	1	2	confirmed payload: 00 00 00 00 00 00 00 00 00
▼ 11:17:57		0	
▲ 11:18:01	0	2	confirmed payload: 00 00 00 00 00 00 00 00 00
⚡ 11:17:52			dev addr: 26 02 22 C0 app eui: 80 00 00 00 00 00 08 dev eui: 2C F7 F1 21 10 70 00 54



## 9.2 Packet Parsing

### 9.2.1 Packet Initialization

After being powered on or reboot, SenseCAP Sensors will be connected to the network using the OTAA activation method. Each Sensor Node will send data packets to the server, including the following data:

**Initial packets** (no need to learn about these initial packets)

One packet with device info including hardware version, software version, battery level, sensor hardware & software version, sensor EUI, power, and sensor power time counter at each channel.

### Measurement data packets

The only thing we should pay attention to is the sensor measurement data packets.

APPLICATION DATA || pause 🗑️ cle

Filters: uplink downlink activation ack error

time	counter	port		
11:19:12		0		
11:19:16	5	2	confirmed	payload: 01 01 10 B0 68 00 00 01 02 10 88 F4 00 00 8C FF <span style="color: red;">Measurement data packets</span>
11:18:58		0		

### Packet Structure

The structure of the frame is shown in the image below.

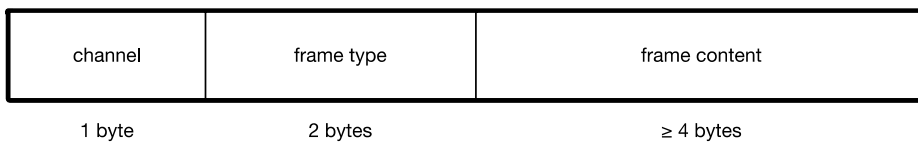

**1 byte for channel**, default as 1, means the sensor has been well connected.

**2 bytes for frame type**, in this case, it will be 0110 and 0210, means temperature value and humidity value

**4 bytes for content**, is the sensor value with CRC

The frame content is sent in **little-endian byte order**.



## 9.3 Data Parsing Example

### 9.3.1 Measurements List

Measurements	Measurement ID (HEX)	Resolution	Unit
Air Temperature	0x1001	0.01	°C
Air Humidity	0x1002	0.01	%RH
Light Intensity	0x1003	1	Lux
CO2	0x1004	1	ppm
Soil Temperature	0x1006	0.1	°C
Soil Moisture	0x1007	0.1	%
Soil EC (Electrical Conductivity)	0x100C	0.01	dS/m



### 9.3.2 Example – S2101 Air Temperature and Humidity Sensor

Air Temperature and Humidity Sensor measurement packet:

01 0110 B0680000 01 0210 88F40000 8CFF

Part	Value	Raw Data	Description
1	Air Temperature	01 0110 B0680000	<p>01 is the channel number.</p> <p>0110 is 0x1001 (little-endian byte order) , which is the measurement ID for air temperature.</p> <p>B0680000 is actually 0x000068B0, whose equivalent decimal value is 26800. Divide it by 1000, and you will get the actual measurement value for air temperature as 26.8°C.</p>
2	Air Humidity	01 0210 88F40000	<p>01 is the channel number.</p> <p>0210 is 0x1002 (little-endian byte order), which is the measurement ID for air humidity.</p> <p>88F40000 is actually 0x0000F488, whose equivalent decimal value is 62600. Divide it by 1000, and you will get the actual value for air humidity as 62.6%RH.</p>
3	CRC	8CFF	The CRC verification part.



### 9.3.1 Example – S2102 Light Intensity Sensor

Light Intensity Sensor measurement packet:

01 0310 A8550200 E3E9

Part	Value	Raw Data	Description
1	Light Intensity	01 0310 A8550200	<p>01 is the channel number.</p> <p>0310 is 0x1003 (little-endian byte order) , which is the measurement ID for Light Intensity.</p> <p>A8550200 is actually 0x000255A8, whose equivalent decimal value is 153000. Divide it by 1000, and you'll get the actual measurement value for Light Intensity as 153 Lux.</p>
3	CRC	E3E9	The CRC verification part.



### 9.3.2 Example – S2103 CO2, Temperature and Humidity Sensor

CO2, Temperature and Humidity Sensor measurement packet:

01 0410 80140700 01 0110 F4650000 01 0210 7C7D0100 3C4D

Part	Value	Raw Data	Description
1	CO2	01 0410 80140700	<p>01 is the channel number.</p> <p>0410 is 0x1004 (little-endian byte order) , which is the measurement ID for CO2.</p> <p>80140700 is actually 0x00071480, whose equivalent decimal value is 464000. Divide it by 1000, and you will get the actual measurement value for CO2 as 464 ppm.</p>
2	Air Temperature	01 0110 F4650000	<p>01 is the channel number.</p> <p>0110 is 0x1001 (little-endian byte order) , which is the measurement ID for air temperature.</p> <p>F4650000 is actually 0x000065F4, whose equivalent decimal value is 26100. Divide it by 1000, and you will get the actual measurement value for air temperature as 26.1 °C.</p>
3	Air Humidity	01 0210 7C7D0100	<p>01 is the channel number.</p> <p>0210 is 0x1002 (little-endian byte order), which is the measurement ID for air humidity.</p> <p>7C7D0100 is actually 0x00017D7C, whose equivalent decimal value is 97660. Divide it by 1000, and you will get the actual measurement value for air humidity as 97.66 %RH.</p>
4	CRC	3C4D	The CRC verification part.





### 9.3.3 Example – S2104 Soil Moisture and Temperature Sensor

Soil Moisture and Temperature Sensor measurement packet:

01 0610 245E0000 01 0710 BCB10000 A3D9

Part	Value	Raw Data	Description
1	Soil Temperature	01 0610 245E0000	<p>01 is the channel number.</p> <p>0610 is 0x1006 (little-endian byte order) , which is the measurement ID for soil temperature.</p> <p>245E0000 is actually 0x00005E24, whose equivalent decimal value is 24100. Divide it by 1000, and you will get the actual measurement value for soil temperature as 24.1°C.</p>
2	Soil Moisture	01 0710 BCB10000	<p>01 is the channel number.</p> <p>0710 is 0x1007 (little-endian byte order), which is the measurement ID for soil moisture.</p> <p>BCB10000 is actually 0x0000B1BC, whose equivalent decimal value is 45500. Divide it by 1000, and you will get the actual measurement value for soil moisture as 45.5%RH.</p>
3	CRC	A3D9	The CRC verification part.



### 9.3.4 Example – S2105 Soil Moisture, Temperature and EC Sensor

Soil Moisture, Temperature and EC Sensor measurement packet:

01 0610 5C5D0000 01 0710 48A30000 01 0C10 B4000000 DD0A

Part	Value	Raw Data	Description
1	Soil Temperature	01 0610 5C5D0000	<p>01 is the channel number.</p> <p>0610 is 0x1006 (little-endian byte order) , which is the measurement ID for soil temperature.</p> <p>5C5D0000 is actually 0x00005D5C, whose equivalent decimal value is 23900. Divide it by 1000, and you will get the actual measurement value for soil temperature as 23.9°C.</p>
2	Soil Moisture	01 0710 48A30000	<p>01 is the channel number.</p> <p>0710 is 0x1007 (little-endian byte order), which is the measurement ID for soil moisture.</p> <p>48A30000 is actually 0x0000B1BC, whose equivalent decimal value is 45500. Divide it by 1000, and you will get the actual measurement value for soil moisture as 45.5%RH.</p>
3	Soil Electrical Conductivity	01 0C10 B4000000	<p>01 is the channel number.</p> <p>0C10 is 0x100C (little-endian byte order), which is the measurement ID for soil EC.</p> <p>B4000000 is actually 0x000000B4, whose equivalent decimal value is 180. Divide it by 1000, and you will get the actual measurement value for soil EC as 0.18 dS/m.</p>
4	CRC	DD0A	The CRC verification part.



## 9.4 Battery Information

Please note the counter number. After 20 packets, it will follow one special packet with battery info.

You can either ignore this packet or get rid of the battery info in your code.

```

18:09:48 Successfully scheduled data downlink ... DevAddr: 27 00 59 27
18:09:48 Schedule data downlink for transmissi... FPort: 5
18:09:48 Forward data message to Application S... DevAddr: 27 00 59 27 FRMPayload: FE 39 78 39 59 DE 1E AB C5 5F 0D 03 BE F6 5E 7E DB 0E 13 4F 44 87 D7 FPort: 2 SNR: 7.5 Bandwidth: 125000
18:09:48 Forward uplink data message DevAddr: 27 00 59 27 FRMPayload: 80 07 00 04 00 05 00 01 06 10 B4 5F 00 00 01 07 10 A4 1F 00 00 32 59 FPort: 2 SNR: 7.5 Bandwidth: 125000
18:09:48 Receive uplink data message DevAddr: 27 00 59 27 Battery Package
18:09:48 Successfully processed data message DevAddr: 27 00 59 27 FPort: 2 FCnt: 5 FRMPayload: FE 39 78 39 59 DE 1E AB C5 5F 0D 03 BE F6 5E 7E DB 0E 13 4F 44 87 D7 Bandwidth: 125000 SNR: 7.5 Raw payload: 80 27 59
18:09:48 Link ACK accept received DevAddr: 27 00 59 27
18:09:48 Receive data message DevAddr: 27 00 59 27 FPort: 2 FCnt: 5 FRMPayload: FE 39 78 39 59 DE 1E AB C5 5F 0D 03 BE F6 5E 7E DB 0E 13 4F 44 87 D7 Bandwidth: 125000 SNR: 7.5 Raw payload: 80 27 59

```

Original Info:

00070064000500010610B45F0000010710A41F00003259

Battery Package: 00070064000500

Example:

Battery & Soil Moisture and Temperature Sensor(S2104) measurement packet:

00070064000500010610B45F0000010710A41F00003259

Part	Value	Raw Data	Description
1	Battery	00 0700 6400 0500	<p>00 is the channel number.</p> <p>0700 is 0x0007 (little-endian byte order) , which is the measurement ID for battery.</p> <p>6400 is 0x0064 (little-endian byte order) , whose equivalent decimal value is 100. Battery level is 100%.</p> <p>0500 is 0x0005 (little-endian byte order) , whose equivalent decimal value is 5. Upload interval is 5 minutes.</p>
2	Soil Temperature	01 0610 B45F0000	<p>01 is the channel number.</p> <p>0610 is 0x1006 (little-endian byte order) , which is the measurement ID for soil temperature.</p> <p>B45F0000 is actually 0x00005FB4, whose equivalent decimal value is 24500. Divide it by</p>



			1000, and you will get the actual measurement value for soil temperature as 24.5°C.
3	Soil Moisture	01 0710 A41F0000	<p>01 is the channel number.</p> <p>0710 is 0x1007 (little-endian byte order), which is the measurement ID for soil moisture.</p> <p>A41F0000 is actually 0x00001FA4, whose equivalent decimal value is 8100. Divide it by 1000, and you will get the actual measurement value for soil moisture as 8.1% RH.</p>
4	CRC	3259	The CRC verification part.



## 10. Device Installation

### 10.1 Installing Sensor

#### 10.1.1 Installing the Sensor Bracket

Specially designed for installing SenseCAP Sensors, the bracket is a sliding cap. With designated screw-holes, the bracket helps fasten the Sensor Node firmly onto a pole or a wall.



- 1) With the sensor in one hand and a bracket in the other, find an unobstructed direction along the back of the sensor.

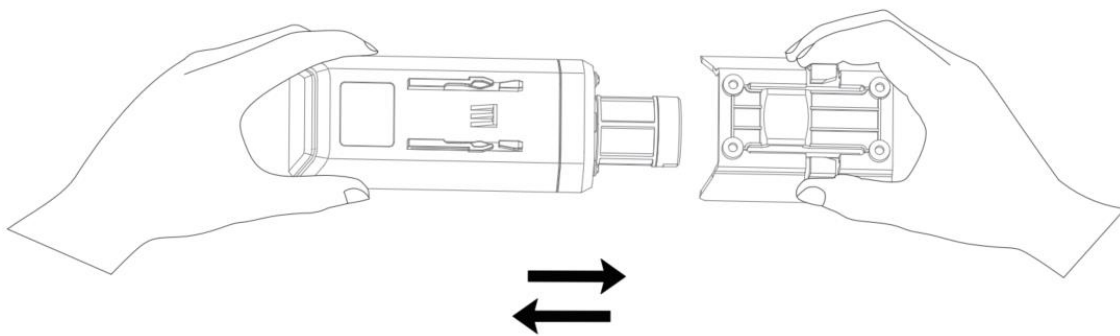

- 2) One hand holds the clasp while the other holds the device. Pull outward with opposite force. Press the upper part of the buckle with your finger.\

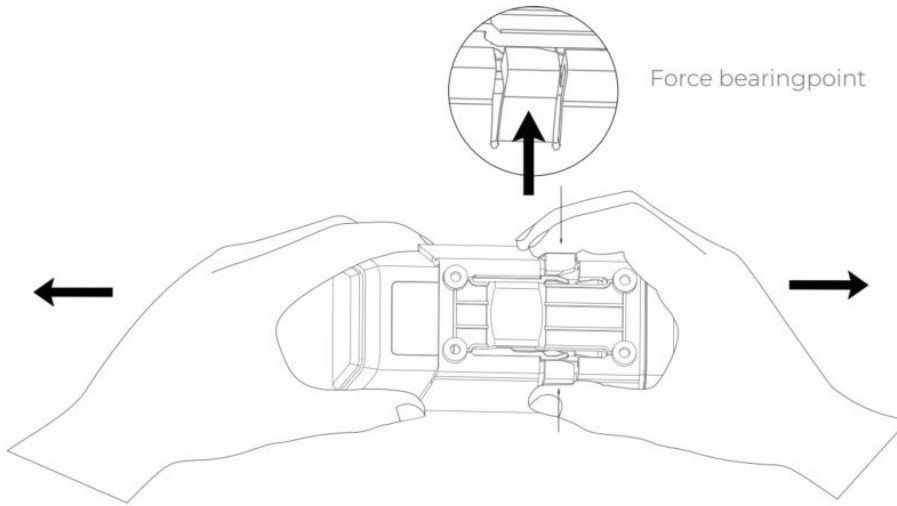

### 10.1.1 Mount on Pole and Wall

- 1) Mount on pole

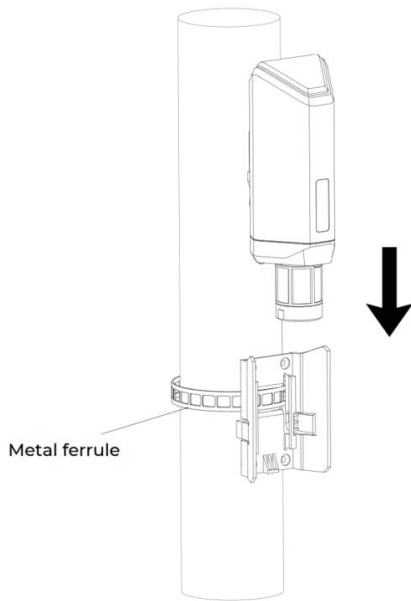

- 2) Mount on wall

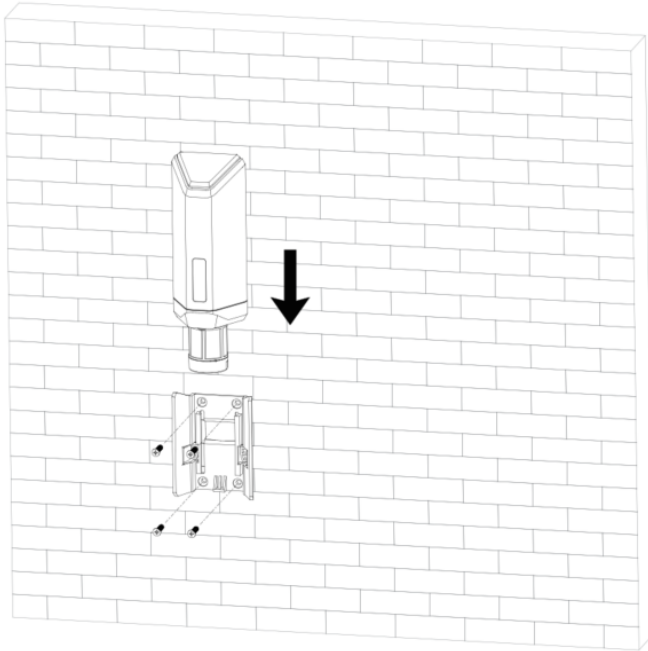



## 10.2 Replace the Battery

### 10.2.1 How to Buy the Battery

We suggest buying it from Amazon.

- 1) EEMB ER34615: [Click here](#)
- 2) Search the key word: LiSOCl<sub>2</sub> ER34615 battery. Compare the batteries that meet the following parameters. The most important thing is to match the voltage.

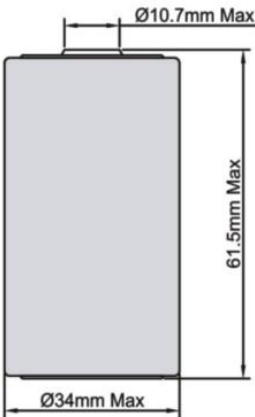
Battery Specification	
Nominal capacity	19000mAh
Model	Li-SOCl <sub>2</sub> , ER34615
Nominal voltage	3.6V
Max. continuous current	230mA
Max. pulse current capability	400mA
Dimension	<p>∅ 34.0*61.5mm (D size)</p>  <p>The diagram shows a cylindrical battery with three dimension lines. A horizontal line at the top indicates a diameter of 10.7mm Max. A vertical line on the right indicates a height of 61.5mm Max. A horizontal line at the bottom indicates a diameter of 34mm Max.</p>
Operating temperature range	-60°C to 85°C





## 10.2.2 How to Replace a New Battery

- 1) Remove three screws.



**Note:**

*The sensor and PCBA are connected by wire, please disassemble carefully.*

---

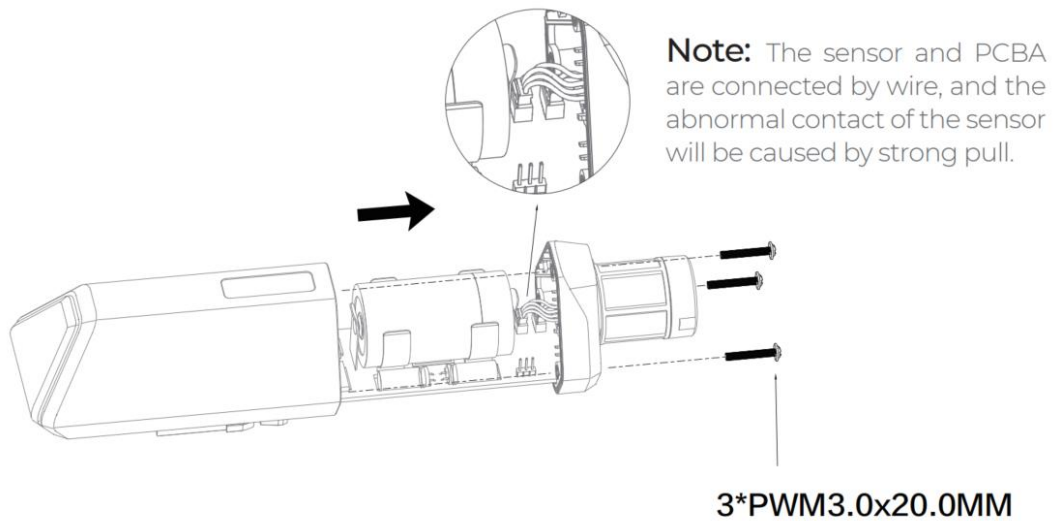

- 2) Install a new battery.



**Note:**

*Pay attention to the positive and negative terminals of the battery.*

---

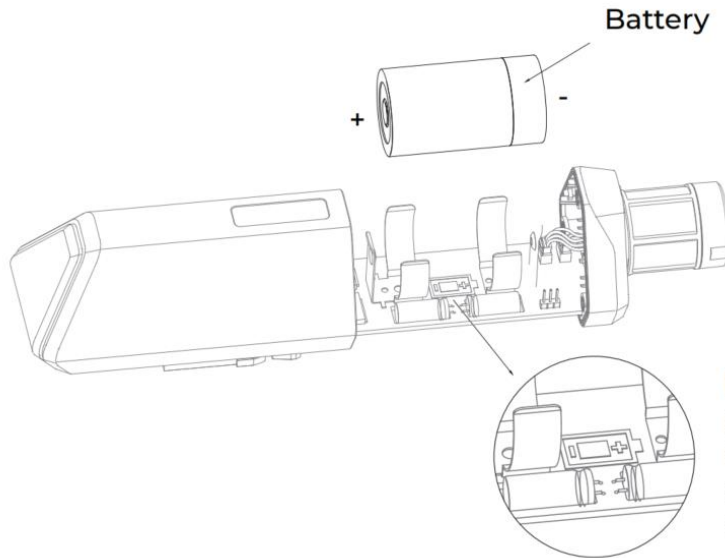

**Note:** Do not invert the positive and negative batteries. Otherwise, short circuit may occur and the device may be damaged.

3) Install screws.

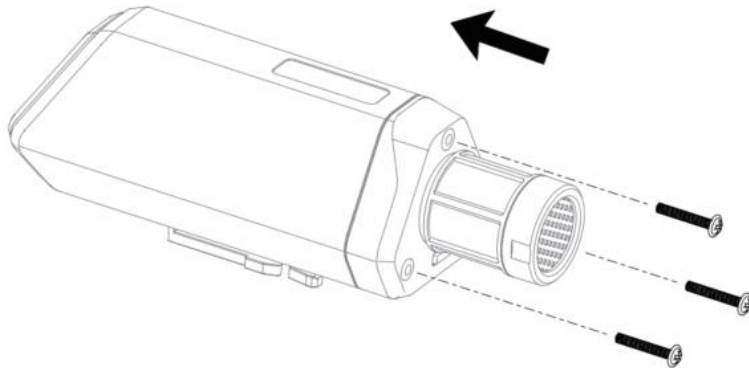

 **Note:**

*During the installation, ensure that the waterproof washer is properly installed and the screws are locked; otherwise, water will flow into the device.*



## 11. Trouble Shooting

### 11.1 Support

Support is provided Monday to Friday, from 09:00 to 18:00 GMT+8. Due to different time zones, we cannot offer live support. However, your questions will be answered as soon as possible in the before-mentioned schedule.

Provide as much information as possible regarding your enquiry (product models, accurately describe your problem and steps to replicate it etc.) and send a mail to: [sensecap@seeed.cc](mailto:sensecap@seeed.cc)

### 11.2 Document Version

Version	Date	Description	Editor
V1.0.0	5/01/2022	First edition	Jenkin Lu