

User Manual

Strips LoRa MS-H

Strips LoRa MS-WL



Hardware Description.....	1
Features and Description.....	2
Joining Strips.....	3
Configuring Strips.....	4-6
User Commands.....	7
Installation Instructions.....	8
Mounting Magnets.....	9
Technical Information.....	10

Hardware Description

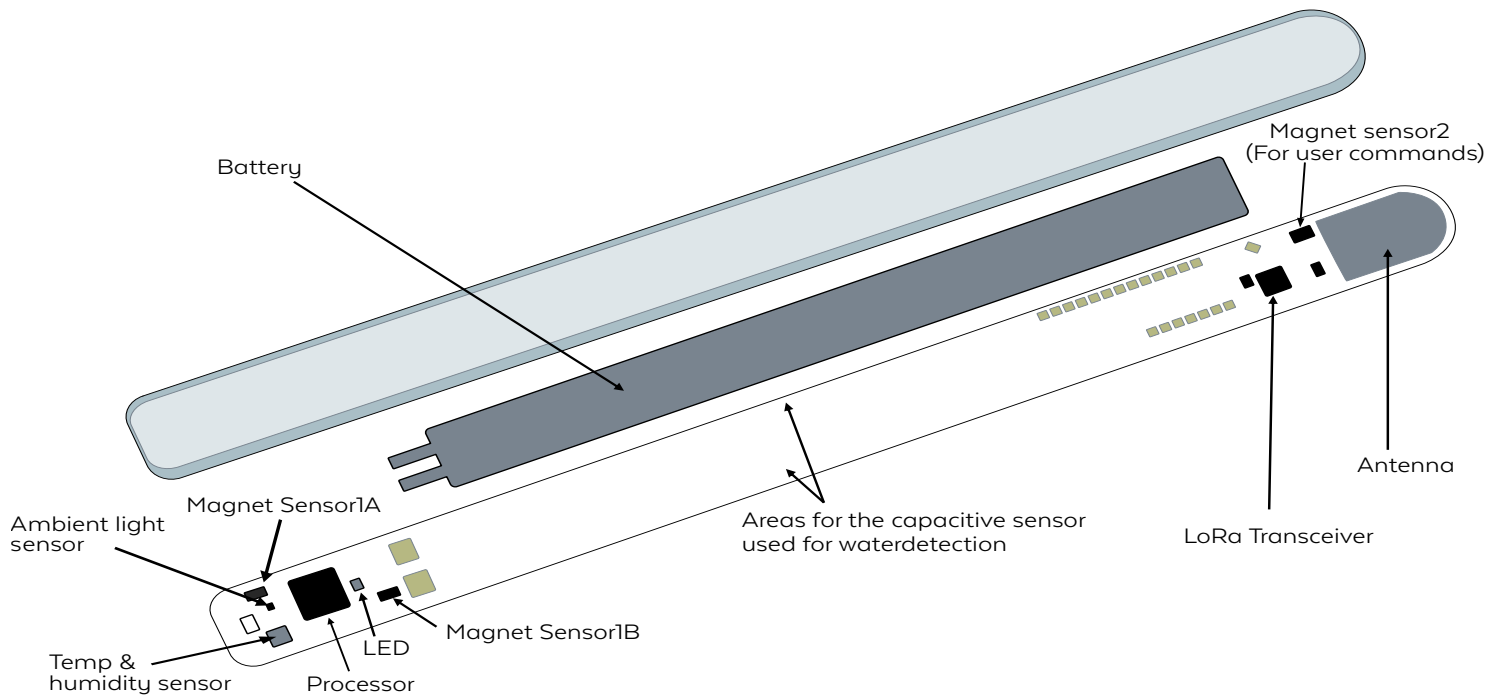

User Manual

Strips LoRa MS-H

Strips LoRa MS-WL



Multi-sensor

- Measures ambient light (LUX)
- Measures temperature and average temperature
- Magnetic contact sensor

Common Features

- Easy Installation
- Long-range
- Up to ten year battery life
- Compatible with LoRaWAN specification 1.0.3

MS-H

Detects humidity



MS-WL

Detects water leak

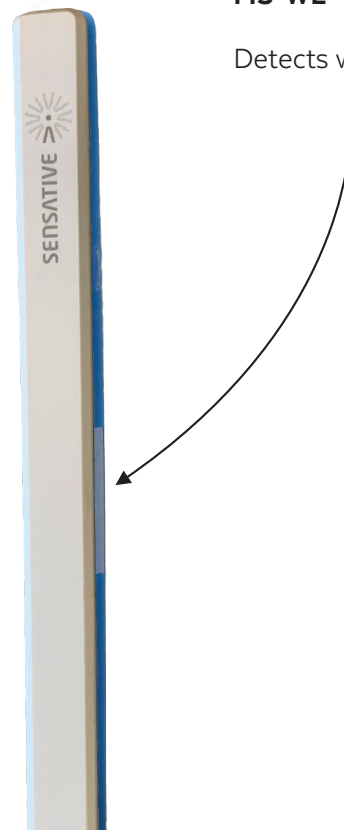

Joining Strips to your network

Strips comes in transport mode, when both of the magnets are attached the device is idle. When removing the magnets for the first time, the device will automatically send a join request.

*Tip : Make sure the device is set up on your server before removing the magnets for the first time.

If you have removed the magnets, and you need to manually join the device, take one of the magnets and move it to the round edge (Magnet sensor 2) of the Strip 3 times (3 green LED blinks at the Sensitive logo). This will send a join request to the server. (See figure A)

One long green LED blink signals the device has been successfully joined to the server

5 red blinks means the device failed to join to the network

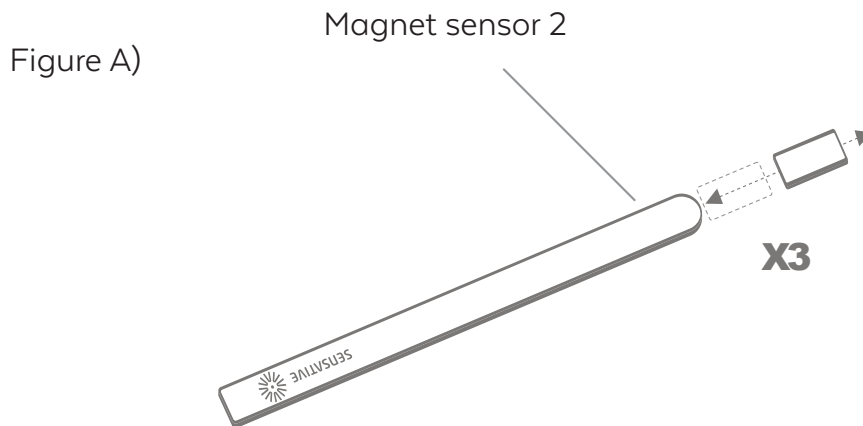

After Strips is included in your network, the device is in default mode, and is only set up as a magnetic contact sensor. In order to configure the device and turn on its many functions, please see the Sensor Configuration instructions.

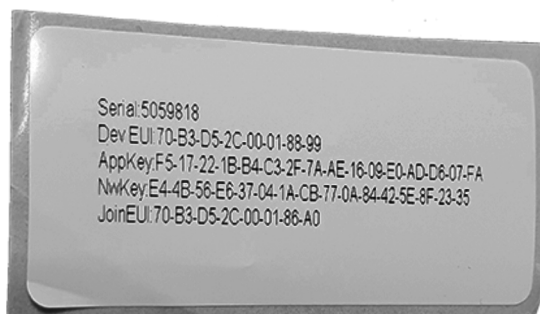

Your devices key information can be found in the package or sent to you digitally. Please contact your Sensitive representative to obtain the key information via e-mail.

Sensor Configuration

After you have joined the device to the network, you are ready to configure the device towards your specification using our down-link generator at :

www.sensative.com/loraconfig

How to use the down-link generator :

Step 1:

Click on the page titled "Enable Reports" and find the alarms or reports you wish to enable for your device.

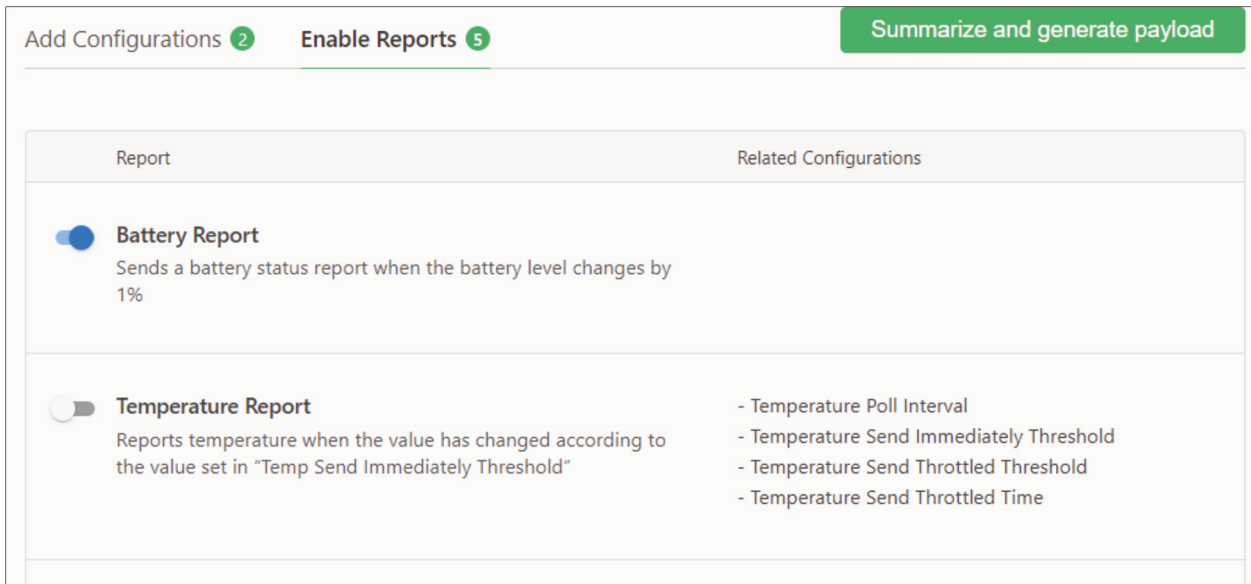

The screenshot shows a web interface for configuring reports. At the top, there are three tabs: "Add Configurations" (with a '2' in a green circle), "Enable Reports" (with a '5' in a green circle), and "Summarize and generate payload" (in a green button). Below the tabs is a table with two columns: "Report" and "Related Configurations".

Report	Related Configurations
<input checked="" type="checkbox"/> Battery Report Sends a battery status report when the battery level changes by 1%	
<input type="checkbox"/> Temperature Report Reports temperature when the value has changed according to the value set in "Temp Send Immediately Threshold"	<ul style="list-style-type: none">- Temperature Poll Interval- Temperature Send Immediately Threshold- Temperature Send Throttled Threshold- Temperature Send Throttled Time

Step 2:

Under "Related Configurations" click the configuration setting you wish to edit (non edited configurations will use default values that are described in the configuration description)

Temperature Report
Reports temperature when the value has changed according to the value set in "Temp Send Immediately Threshold"

- Temperature Poll Interval
- Temperature Send Immediately Threshold
- Temperature Send Throttled Threshold
- Temperature Send Throttled Time

Step 3:

Review the description and enter the new value if you wish to change it from the default setting. Then click "Add configuration"

Select category
Temperature

Select configuration
Temperature Low Alarm

 **Temperature Low Alarm**

Description
Sends an alarm when temperature goes below the set value (will send temperature alarm, not report).

Unit	Default value	Allowed values	Related reports 
Celsius	-40	-20-120	- Temperature Alarm

New value
44

Add configuration

Step 4:

You may add/edit as many configuration and settings as you wish, once you have finished adding your settings, click the "Summarize and generate payload" button.



Step 5:

Review the configurations and reports that were edited, remove any if necessary.



Step 6:

Lastly, copy the payload and send the down-link via your server application on port 11. Strips is a type A device, so an open frame must be sent in order to receive the down-link, to do this : Move the magnet over the rounded edge 3 time (3 LED blinks)

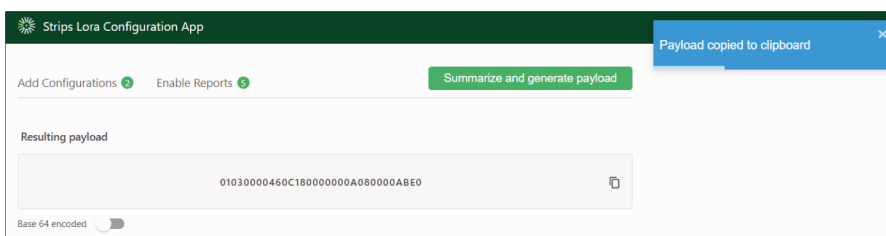

User commands

1. Sending open frame

Move the magnet to the rounded edge 3 times (see 3 green LED blinks at Sensitive logo)

1 short blink means the frame was sent (success)

5 red means there was no acknowledgment from the gateway

2. Factory reset

To reset the device to the factory settings, move the magnet to the rounded edge 3 times, and on the 3rd pass hold the magnet for 10 seconds. One long green LED blink means reset was successful

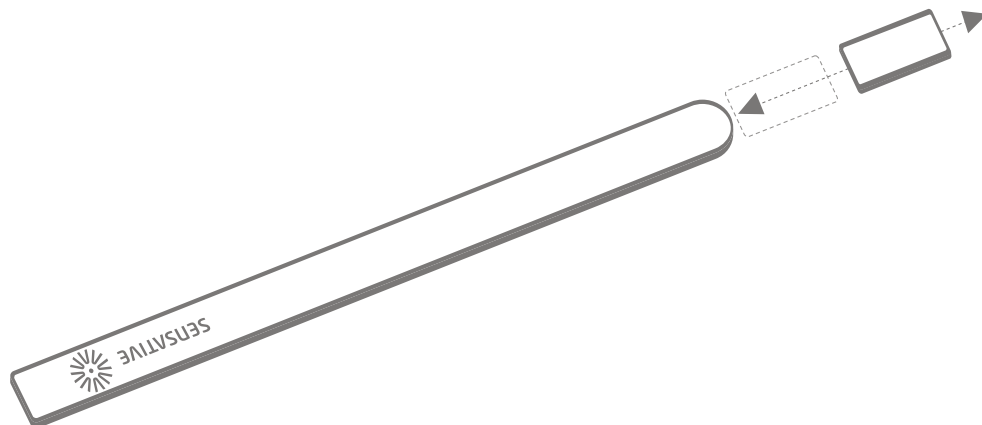



Installation instructions

To mount MS-WL to base plate for water leak detection:

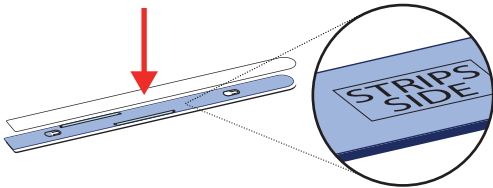
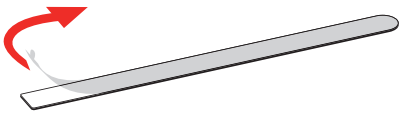

Mount Strips on "Strips side" of the mounting plate

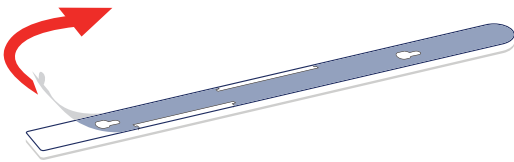

Optional mounting plate instructions

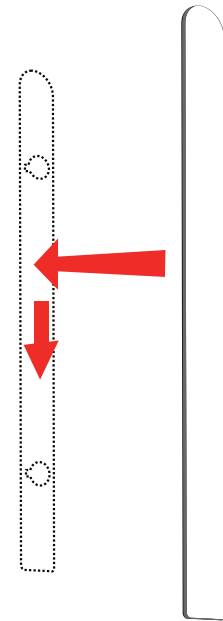
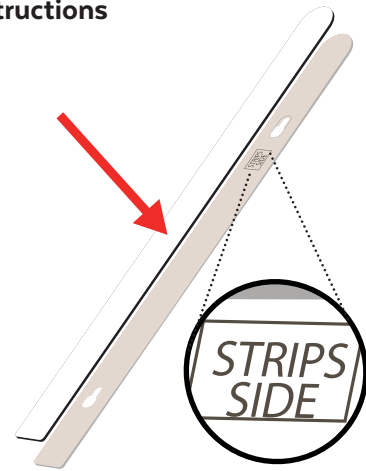

How to mount magnets for door/window set up.

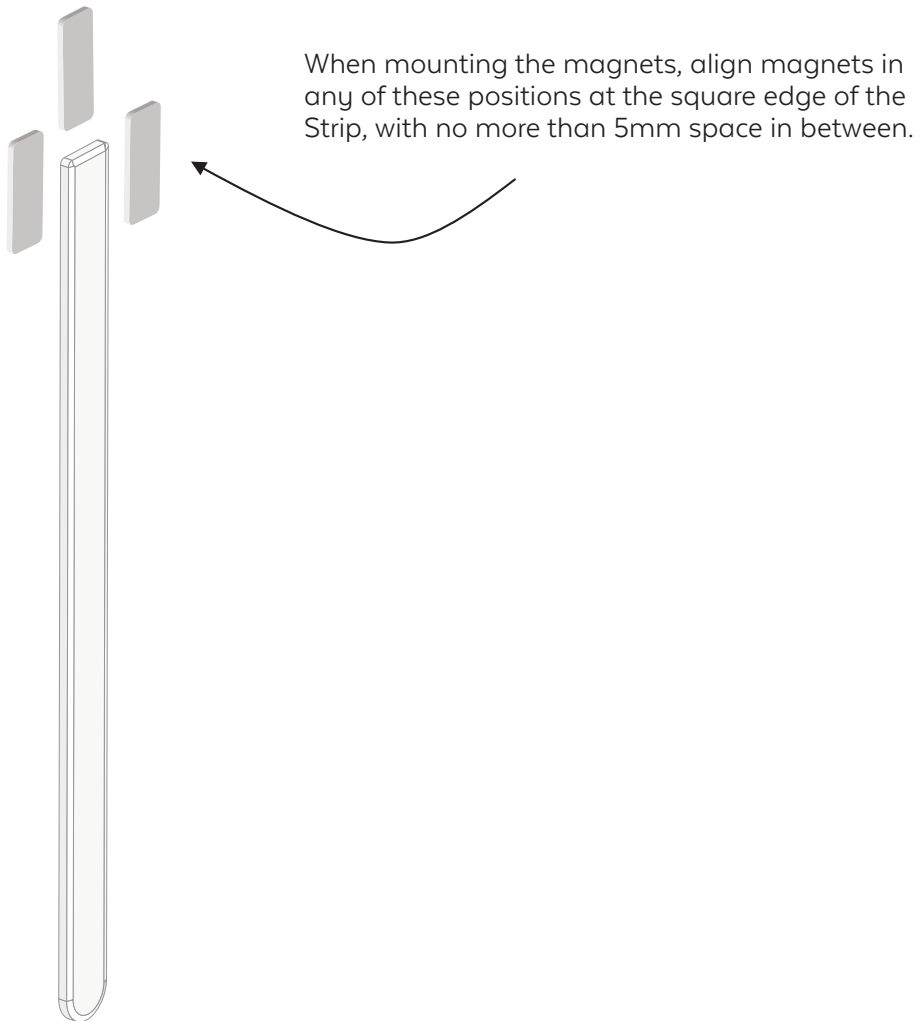

Technical Information

Product	Strips LoRa MS-H Sensor	Product	Strips LoRa MS-LW sensor
Features	LED indication Temperature sensor (+/- 0.40°C) Humidity sensor (+/- 3% RH) Ambient light sensor (1-64000 LUX)	Features	Magnet sensor LED indication Temperature +/- 0.25 degree C accuracy Ambient Light 1-64000 LUX Flooding alert
Regions	Europe (863-870 MHz) North America (902 - 928 MHz)	Regions	Europe (863-870 MHz) North America (902 - 928 MHz)
Range	Up to + 14 dBm output power Rx sensitivity -137 dBm Up to 10 km range (free line of sight)	Range	Up to + 14 dBm output power Rx sensitivity -137 dBm Up to 10 km range (free line of sight)
Dimensions	Sensor: 195*15*2.98 mm Magnet: 12*2 mm Mounting plate: 195*15*3 mm	Dimensions	Sensor: 195*15*2.98 mm Magnets: A: 30*11*1 mm B: Diameter 12 * 3 mm
Operating conditions	-30 to +60 degree C. Indoor usage	Operating conditions	-30 to + 60 degree C. In- and outdoor usage.
Power supply	Built-in battery (LiMnO2). 10 years battery life	Power supply	Built-in battery (LiMnO2). Life span up to 10 years
Magnetic range	Approx. 10 mm	Magnetic range	Approx. 10 mm
Supports	LoRaWAN v1.0.3 OTAA configuration	Supports	LoRaWAN v1.0.3 OTAA configuration

Prolonged Exposure to High Humidity **

Prolonged exposure to high humidity will result in a gradual upward drift of the RH reading. The shift in sensor reading resulting from this drift will generally disappear slowly under normal ambient conditions. The amount of shift is proportional to the magnitude of relative humidity and the length of exposure. In the case of lengthy exposure to high humidity, some of the resulting shift may persist indefinitely under typical conditions.