



TEKTELIC COMMUNICATIONS INC.

EU KONA MICRO EN 300-220-2 COMPLIANCE REPORT

Name: EU Kona Micro EN 300-220-2 Compliance Report
Revision: 0.3
Issue Date: 27/04/2018
Status: *Draft*

Confidential: This document is TEKTELIC Communications Inc. confidential information.
Possession or distribution of this document requires TEKTELIC Communications Inc. consent.

Document Revision

Revision	Issue Date	Author	Comments
0.1	April 3, 2018	A. Macpherson	Initial Draft, based on Kona Pico v1.0
0.2	April 18, 2018	A. Macpherson	Updated figures to show 12V input
0.3	April 27, 2018	D. Blair, A. Macpherson	Added results for 27 dBm RX2 Window (869.525 MHz)

Table of Contents

- 1 Introduction..... 8
 - 1.1 Scope 8
 - 1.2 Test Setup..... 9
 - 1.2.1 Test Diagrams..... 9
 - 1.2.2 Test Equipment..... 10
- 2 Test Conditions 11
 - 2.1 Environmental Profile 11
 - 2.2 Operating Frequency..... 11
 - 2.3 Test Waveform..... 11
 - 2.4 Device Under Test (DUT)..... 12
- 3 Measurements..... 13
 - 3.1 TX Effective Radiated Power 13
 - 3.1.1 Test description..... 13
 - 3.1.2 Results..... 13
 - 3.1.3 Conclusions 14
 - 3.2 Maximum E.R.P Spectral Density 14
 - 3.2.1 Test description..... 14
 - 3.2.2 Results..... 14
 - 3.2.3 Conclusions 16
 - 3.3 Duty cycle 16
 - 3.4 Occupied Bandwidth 17
 - 3.4.1 Test description..... 17
 - 3.4.2 Results..... 18
 - 3.4.3 Conclusions 19
 - 3.5 Frequency Error..... 19
 - 3.5.1 Test description..... 19
 - 3.6 Tx Out of Band Emissions..... 20
 - 3.6.1 Test description..... 20

3.6.2	Results	22
3.6.3	Conclusions	24
3.7	Unwanted Emissions in the Spurious Domain – Radiated Emissions	24
3.7.1	Test Description	24
3.8	Unwanted Emissions in the Spurious Domain – Conducted Emissions	24
3.8.1	Test Description	24
3.8.2	Results	25
3.8.3	Conclusions	30
3.9	Transient Power	30
3.9.1	Test Description	30
3.9.2	Results	32
3.9.3	Conclusions	33
3.10	Adjacent Channel Power	33
3.11	TX Behaviour under Low Voltage Conditions	33
3.12	Adaptive Power Control	33
3.13	FHSS Equipment	33
3.14	Short Term Behaviour	33
3.15	RX Sensitivity	34
3.15.1	Test Description	34
3.15.2	Results	35
3.15.3	Conclusions	36
3.16	Adjacent Channel Selectivity	36
3.17	Receiver Saturation	36
3.18	Spurious Response Rejection	36
3.19	Behaviour at High Wanted Signal Level	36
3.20	Blocking	37
3.20.1	Test Description	37
3.20.2	Results	37
3.20.3	Conclusions	37

4 Summary..... 38

List of Tables

Table 1-1: Kona Micro Product Summary.....	8
Table 1-2: Test Equipment.....	10
Table 2-1: Environmental Operating Conditions	11
Table 2-2: Channels used for testing	11
Table 2-3: Test Waveform Characteristics.....	11
Table 2-4: DUT Summary	12
Table 2-5: DUT Summary – RX2 Window Only	12
Table 3-1: Maximum Radiated Power Limit	13
Table 3-2: Maximum Radiated Power Limit – RX2 Window Only	13
Table 3-3: Effective Radiated Power Summary	13
Table 3-4: Effective Radiated Power Summary – RX2 Window Only	14
Table 3-3: Maximum Effective Radiated Power Spectral Density	14
Table 3-6: Occupied BW Results.....	19
Table 3-7: Occupied BW Results – RX2 window	19
Table 3-8: Emission Limits in the Out of Band Domains.....	21
Table 3-9: Spurious Domain Emission Limits	25
Table 3-10: Parameters for TX Spurious Measurements.....	25
Table 3-11: Summary of Detected Spurs	29
Table 3-12: Summary of Detected Spurs – RX2 Window	30
Table 3-13: Transmitter Transient Power Limits	30
Table 3-14: Transient Power Measurement Parameters	31
Table 3-15: Transient Power Results	32
Table 3-16: Transient Power Results - RX2 Window.....	33
Table 3-17: Limits for Receiver Sensitivity.....	34
Table 3-18: Blocking Level Parameters for RX Category 1.5.....	37
Table 3-19: Blocking Performance	37
Table 4-1: Compliance Summary	38

List of Figures

Figure 1-1: Kona Micro Test Diagram – Tx Tests	9
Figure 1-2: Kona Micro Test Diagram – Rx Tests	9
Figure 3-1: 6dBm Setting, 5.4 dBm Measured Output Power	15
Figure 3-1: RX2 Window 5dBm Setting, 5.4 dBm Measured Output Power	16
Figure 3-2: Occupied BW MXA Output	18
Figure 3-4: Out of Band Domain for Operating Channel	20
Figure 3-5: Out of Band Domain for Operational Frequency Band	21
Figure 3-6: Out of Band Emissions - 863.1MHz Carrier	22
Figure 3-7: Out of Band Emissions - 866.5MHz Carrier	22
Figure 3-8: Out of Band Emissions - 869.9MHz Carrier	23
Figure 3-9: Out of Band Emissions – 27 dBm RX2 window, 869.525 MHz Carrier	23
Figure 3-10: Spectrum Mask for Unwanted Emissions.....	24
Figure 3-11: 30MHz to 869 MHz Spurious Emissions, 869.9 MHz Transmit Signal.....	26
Figure 3-12: 860.6 MHz to 865.6 MHz Spurious Emissions, 863.1 MHz Transmit Signal.....	27
Figure 3-13: 864 MHz to 1 GHz Spurious Emissions, 863.1 MHz Transmit Signal.....	27
Figure 3-14: 1 GHz to 3.7 GHz Spurious Emissions, 863.1 MHz Transmit Signal.....	28
Figure 3-15: 30MHz to 1 GHz Spurious Emissions, RX Only.....	28
Figure 3-16: 1 GHz to 3.7 GHz Spurious Emissions, RX Only.....	29
Figure 3-17: Rx Sensitivity, 125 kHz SF7	35
Figure 3-18: Rx Sensitivity, 125 kHz SF10	35
Figure 3-19: Rx Sensitivity, 500 kHz SF7	36

1 Introduction

1.1 Scope

This report summarizes the results of compliance testing for EU Kona Micro Gateway in accordance to ETSI EN 300 220-2 v3.1.1.

This report applies to the TEKTELIC modules below:

Table 1-1: Kona Micro Product Summary

Product Name	Product Code	Description
Kona Micro	T0005127	LORA GATEWAY MODULE, KONA MICRO, EU, LTE MODEM
Kona Micro	T0005128	LORA GATEWAY MODULE, KONA MICRO, EU, LTE MODEM, BATTERY BACKUP
Kona Micro	T0005205	LORA GATEWAY MODULE, KONA MICRO, EU, BATTERY BACKUP
Kona Micro	T0005206	LORA GATEWAY MODULE, KONA MICRO, EU

1.2 Test Setup

1.2.1 Test Diagrams

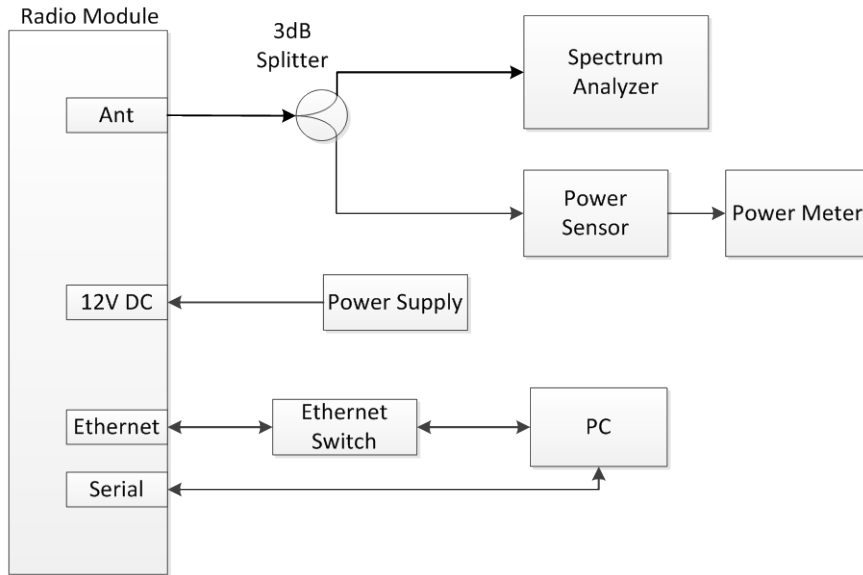

Figure 1-1: Kona Micro Test Diagram – Tx Tests

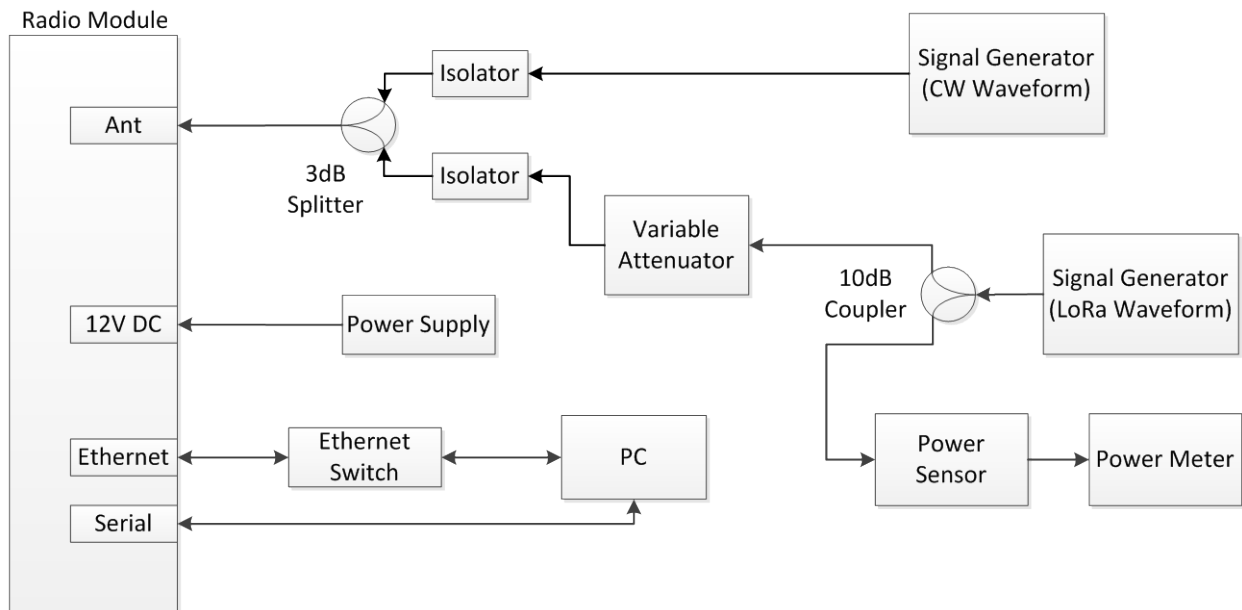

Figure 1-2: Kona Micro Test Diagram – Rx Tests

Note that in the case of RX2 Window TX testing, 10 dB of attenuation was added into the power sensor path and the spectrum analyzer path due to the higher transmit power (27 dBm).

1.2.2 Test Equipment

Table 1-2 lists test equipment used for compliance testing. Equipment used in this test setup may be replaced with equivalent devices from other manufacturers as long as they have similar specifications.

Table 1-2: Test Equipment

Description	Mfg.	Mfg. PN
Spectrum Analyzer	Keysight	N9020A
Power Meter (Tx)	Keysight	E4419B
Power Sensor (Tx)	Keysight	E9301A
Signal Generator (LoRa Waveforms)	Keysight	E4438C
Signal Generator (CW Waveform)	Keysight	E4432B
Power Meter (Rx)	Keysight	N1912A
Power Sensor (Rx)	Keysight	N1921A
Switchable Attenuator	Keysight	8494G/8496G
Attenuator/Switch Driver	Keysight	11713A
10dB couple	Narda	4242-10
Isolator (x2)	Ditom	D3I0810S
3dB Splitter	Mini Circuits	ZAPD-2-21-3W-S

2 Test Conditions

2.1 Environmental Profile

The EU Kona Micro Gateway is designed to operate in the following environmental conditions:

Table 2-1: Environmental Operating Conditions

Parameter	Operating Specification
Operating Temperature	0C to 40C Ambient

2.2 Operating Frequency

The EU Kona Micro is designed to operate in the EU ISM band of 863-870MHz. Testing will be performed at the low, mid and high channel frequencies specified in Table 2-2.

Table 2-2: Channels used for testing

Description	Center Frequency (MHz)
Low	863.1
Mid	866.5
High	869.9
RX2 Window (27 dBm)	869.525

2.3 Test Waveform

The test waveform used for compliance testing unless otherwise stated has the following characteristics:

Table 2-3: Test Waveform Characteristics

Parameter Description	Value
Spreading Factor	SF7
Bandwidth	125kHz
Modulation	LoRa
ETSI Test Signal Classification	D-M3

2.4 Device Under Test (DUT)

A summary of the DUT is shown in Table 2-4.

Table 2-4: DUT Summary

Description	Value
TCODE	T0005127
Serial Number	1813K0011
Revision	A
SW Version	1.0.1

Table 2-5: DUT Summary – RX2 Window Only

Description	Value
TCODE	T0005094 (PCBA)
Serial Number	1809D0001 (PCBA)
Revision	C1 (PCBA)
SW Version	?

3 Measurements

3.1 TX Effective Radiated Power

3.1.1 Test description

The maximum conducted power setting of the EU Kona Micro Gateway is 14dBm at the antenna port. This will correspond to a radiated power of 25mW E.R.P when using a dipole antenna.

Measurements are taken in accordance to ETSI EN 300 220-1 v3.1.1 section 5.2.2.1.

This test is required to be tested at extreme operating conditions.

Table 3-1: Maximum Radiated Power Limit

Test Limit Description	Test Limits
Conducted Power at Antenna Port	25mW E.R.P

Table 3-2: Maximum Radiated Power Limit – RX2 Window Only

Test Limit Description	Test Limits
Conducted Power at Antenna Port	27 dBm

3.1.2 Results

Measurements made in Table 3-2 were made using a spectrum analyzer in accordance to ETSI EN 300 220-1 v3.1.1 section 4.3.10.

Table 3-3: Effective Radiated Power Summary

Ambient Temperature (°C)	Power Setting (dBm)	Measured Power @863.1MHz	Measured Power @866.5MHz	Measured Power @869.9MHz
0	12	13.4	13.6	13.8
25	13	13	13.1	13.3
40	14	13.3	13.5	13.7

Table 3-4: Effective Radiated Power Summary – RX2 Window Only

Ambient Temperature (°C)	Power Setting (dBm)	Measured Power @869.525MHz (dBm)
0	25	26.87
25	25	26.76
40	25	26.53

3.1.3 Conclusions

All conducted power measurements are equal to or below 14dBm (27 dBm in the case of the RX2 Window) so the unit is compliant. The power setting in software was manually changed at the extreme temperatures to remain compliant. An automated solution to apply this change based on an internal temperature sensor will be implemented.

If an antenna with gain greater than 2.15dBi is used, the maximum allowable power setting of the Gateway will be:

$$\text{Max allowable power setting} = 14\text{dBm} - (\text{Antenna Gain} - 2.15\text{dB})$$

3.2 Maximum E.R.P Spectral Density

3.2.1 Test description

Measurements are taken in accordance to ETSI EN 300 220-2 v3.1.1 section 5.3. Operation of the Kona Micro may fall in Operational Frequency Band L.

Table 3-5: Maximum Effective Radiated Power Spectral Density

Frequency Band	Test Limits
865MHz to 868MHz	-4.5dBm/100kHz or 6.2dBm/100kHz if operation is limited to 865 to 868MHz

3.2.2 Results

Measurements were made at 866.5MHz to determine the power level required to meet the limits specified in Table 3-3. Only single carrier operation was tested.

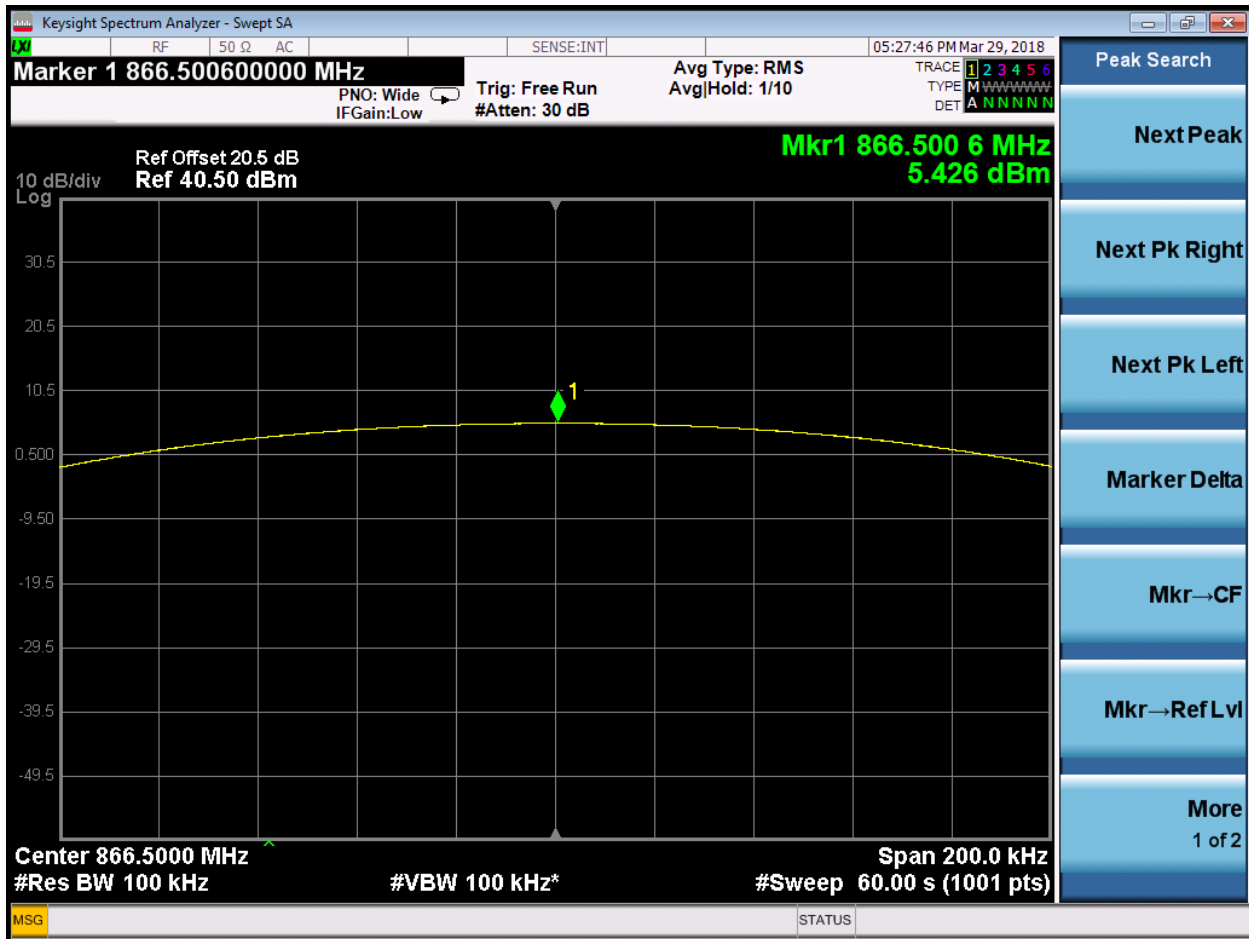

Figure 3-1: 6dBm Setting, 5.4 dBm Measured Output Power

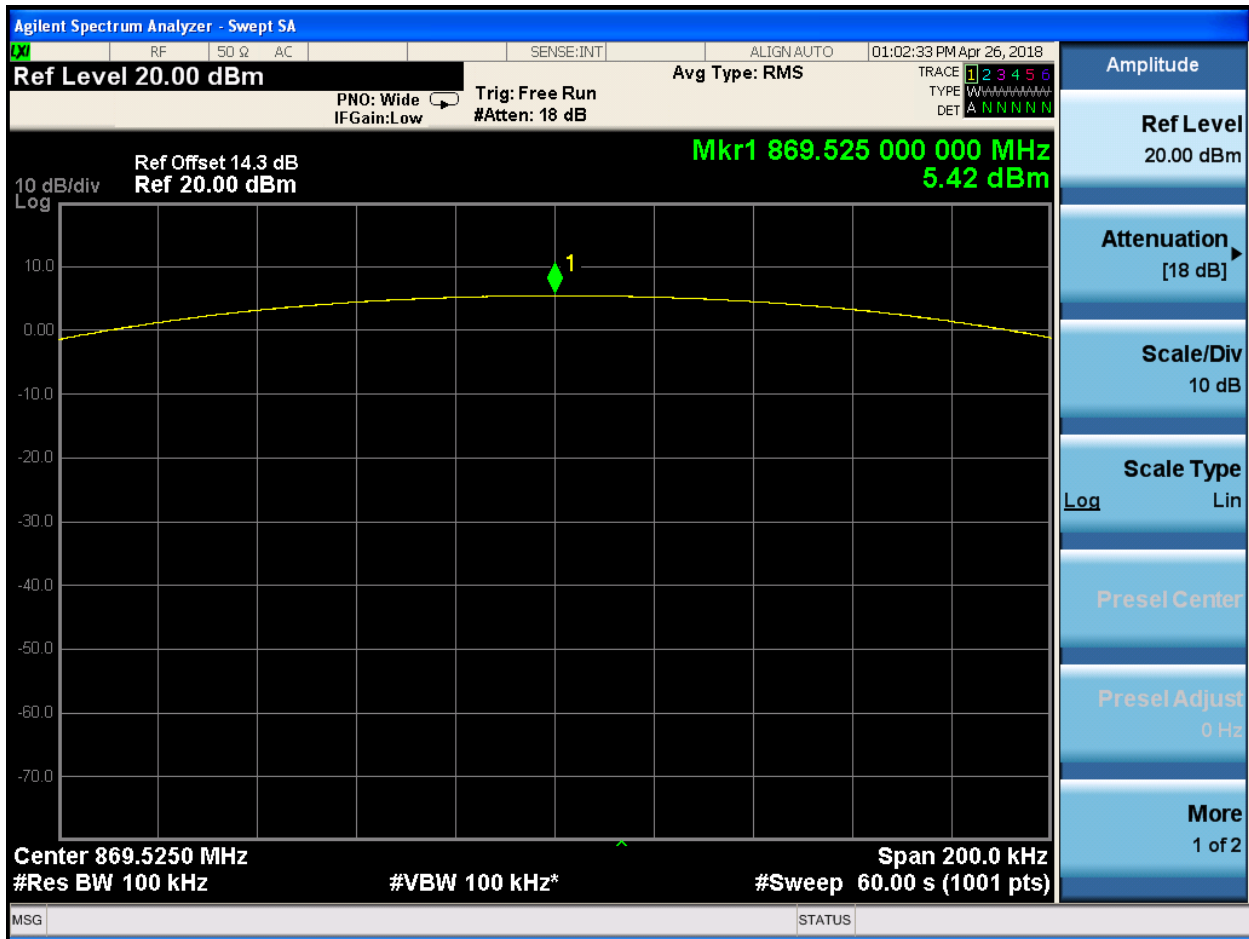

Figure 3-2: RX2 Window 5dBm Setting, 5.4 dBm Measured Output Power

3.2.3 Conclusions

To achieve a 6.2dBm/100kHz PSD, the maximum allowable setting for the radio is 6dBm (5dBm for RX2 Window). More investigation into the interpretation of this specification is required to determine the applicability to LoRa radios.

3.3 Duty cycle

Duty cycle limitations when operating in the EU ISM will be governed by the LoRa Network Server. Since the Gateway does not have control over its transmit duty cycle (it will transmit

whenever it is told), it is up to the network server to comply with duty cycle requirements. Therefore there is no test requirement on the Gateway alone.

3.4 Occupied Bandwidth

3.4.1 Test description

Occupied bandwidth of the LoRa waveform is the frequency range in which 99 % of the total mean power of a given emission falls.

Measurements are taken in accordance to ETSI EN 300 220-2 v3.1.1 section 5.6.

Occupied BW must reside in the Operational Channel Width of 200kHz. This test is required to be tested at extreme operating conditions.

3.4.2 Results

The Occupied BW measurement of the MXA was used for this measurement. A sample output is shown in Figure 3-2.

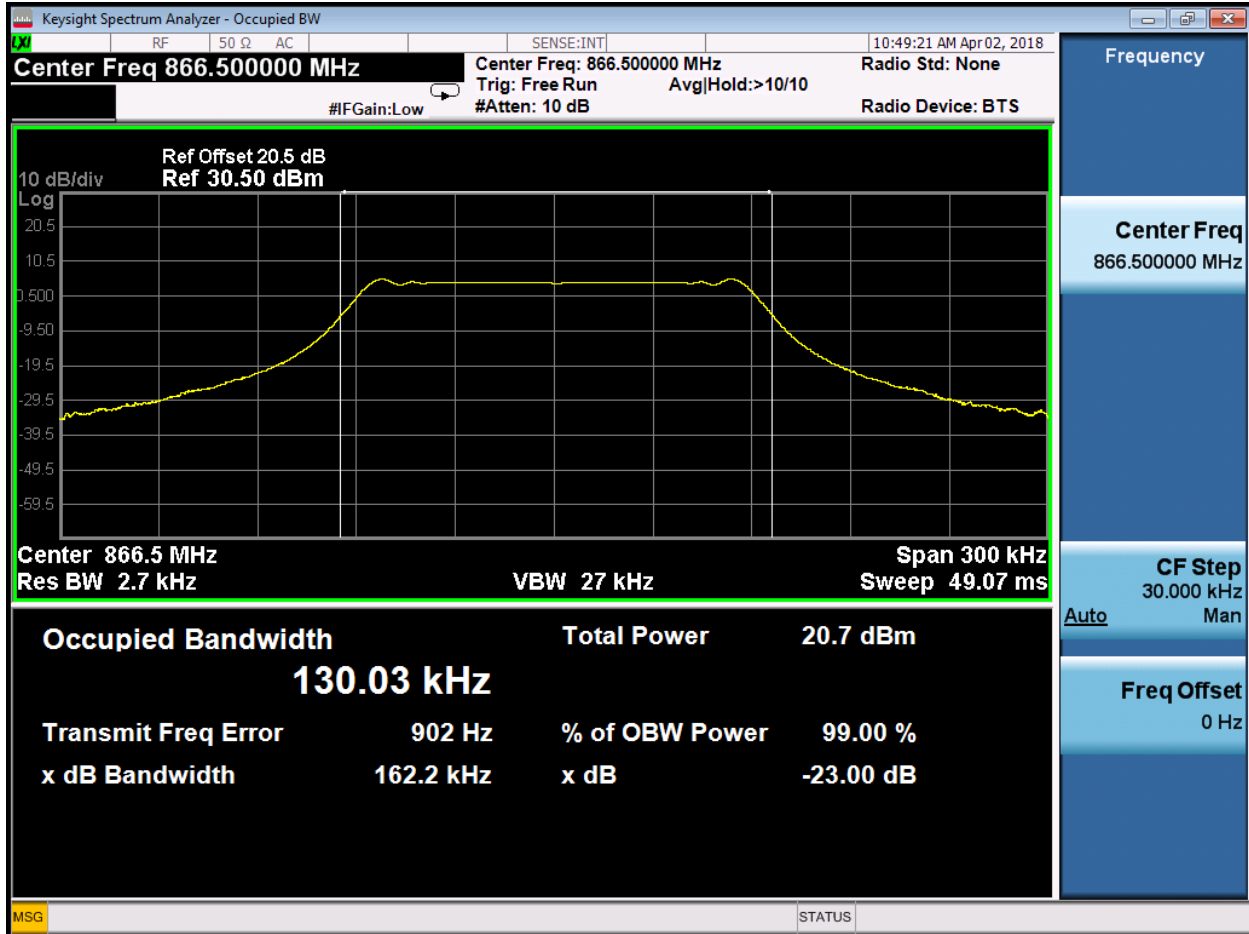

Figure 3-3: Occupied BW MXA Output

Results for Occupied BW are summarized in Table 3-4.

Table 3-6: Occupied BW Results

Ambient Temperature (°C)	Power Setting (dBm)	Frequency (MHz)	Occupied BW (kHz)	-23dB Bandwidth (kHz)
0	12	863.1	130.02	162.1
	12	866.5	130.02	162.2
	12	869.9	130.01	162.0
25	13	863.1	130.08	162.4
	13	866.5	130.01	162.2
	13	869.9	130.01	162.4
40	14	863.1	129.97	161.9
	14	866.5	129.99	162.1
	14	869.9	130.00	162.1

Table 3-7: Occupied BW Results – RX2 window

Ambient Temperature (°C)	Power Setting (dBm)	Frequency (MHz)	Occupied BW (kHz)	-23dB Bandwidth (kHz)
0	25	869.525	130.1	162.3
25	25	869.525	130.0	162.0
40	25	869.525	130.1	162.1

3.4.3 Conclusions

All measurements are within the 200kHz Operational Channel Width and are therefore compliant.

3.5 Frequency Error

3.5.1 Test description

This test is not applicable as the module does not generate an unmodulated carrier.

3.6 Tx Out of Band Emissions

3.6.1 Test description

This test will measure out-of-band emissions of the Kona Micro Gateway.

Measurements are taken in accordance to ETSI EN 300 220-2 v3.1.1 section 5.8.3.3.

Power was adjusted at each temperature as described in section 3.1 to keep the output power just under the limit of 14 dBm (27 dBm in the case of the RX2 window).

Out of Band Emissions are defined for two domains, Operating Channel and Operational Frequency Band. Diagrams of the limits are shown in Figure 3-3 and Figure 3-4 and are also summarized in Table 3-5: Emission Limits in the Out of Band Domains.

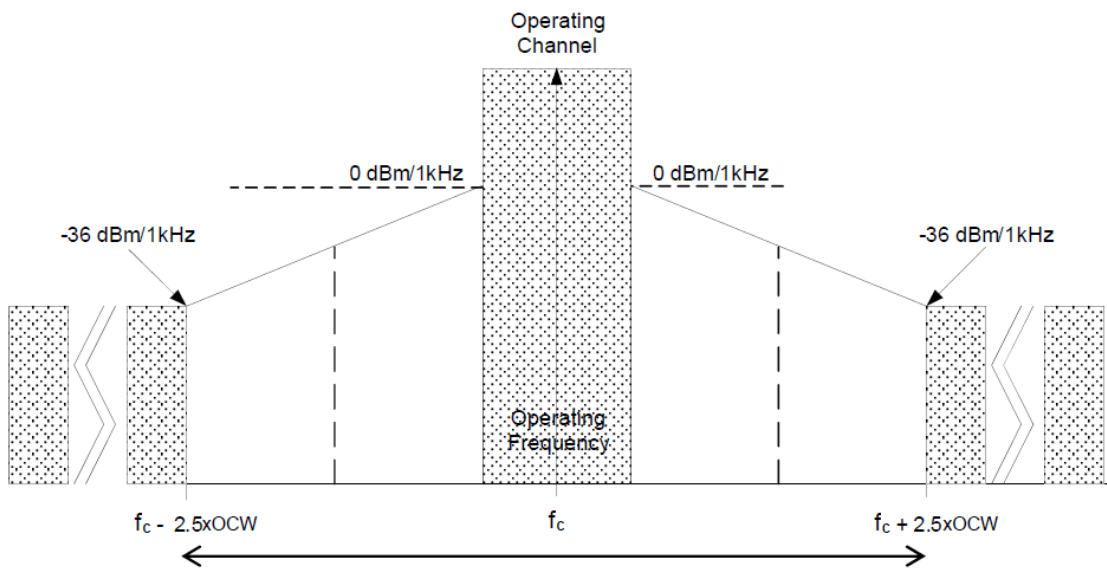

Figure 3-4: Out of Band Domain for Operating Channel

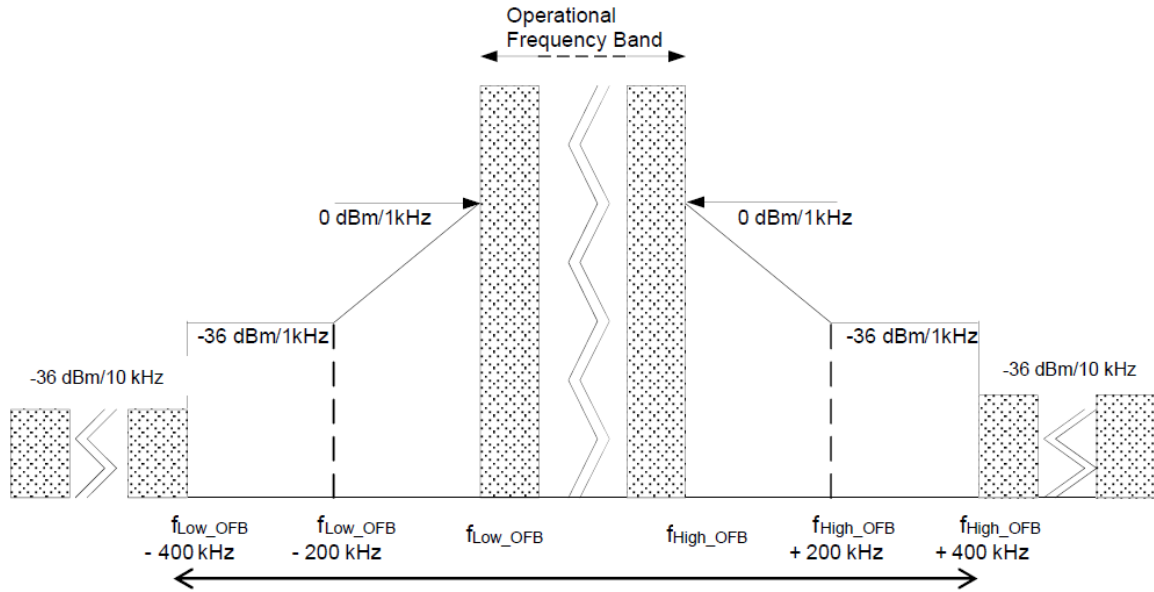

Figure 3-5: Out of Band Domain for Operational Frequency Band

Table 3-8: Emission Limits in the Out of Band Domains

Domain	Frequency Range	RBW _{REF}	Max power limit
OOB limits applicable to Operational Frequency Band (See Figure 6)	$f \leq f_{low_OFB} - 400 \text{ kHz}$	10 kHz	-36 dBm
	$F_{low_OFB} - 400 \text{ kHz} \leq f \leq f_{low_OFB} - 200 \text{ kHz}$	1 kHz	-36 dBm
	$f_{low} - 200 \text{ kHz} \leq f < f_{low_OFB}$	1 kHz	See Figure 6
	$f = f_{low_OFB}$	1 kHz	0 dBm
	$f = f_{high_OFB}$	1 kHz	0 dBm
	$F_{high_OFB} < f \leq f_{high_OFB} + 200 \text{ kHz}$	1 kHz	See Figure 6
	$F_{high_OFB} + 200 \text{ kHz} \leq f \leq f_{high_OFB} + 400 \text{ kHz}$	1 kHz	-36 dBm
	$F_{high_OFB} + 400 \text{ kHz} \leq f$	10 kHz	-36 dBm
OOB limits applicable to Operating Channel (See Figure 5)	$f = f_c - 2.5 \times \text{OCW}$	1 kHz	-36 dBm
	$f_c - 2.5 \times \text{OCW} \leq f \leq f_c - 0.5 \times \text{OCW}$	1 kHz	See Figure 5
	$f = f_c - 0.5 \times \text{OCW}$	1 kHz	0 dBm
	$f = f_c + 0.5 \times \text{OCW}$	1 kHz	0 dBm
	$f_c + 0.5 \times \text{OCW} \leq f \leq f_c + 2.5 \times \text{OCW}$	1 kHz	See Figure 5
	$f = f_c + 2.5 \times \text{OC}$	1 kHz	-36 dBm
NOTE:	<p>f is the measurement frequency. f_c is the Operating Frequency. F_{low_OFB} is the lower edge of the Operational Frequency Band. F_{high_OFB} is the upper edge of the Operational Frequency Band. OCW is the operating channel bandwidth.</p>		

This test is required to be tested at extreme operating conditions.

3.6.2 Results

Single carrier operation was measured at three frequencies across the band and compared against Operational Channel (OC) and Operation Frequency Band (OFB) limits. The results are shown in Figure 3-5 through Figure 3-7.

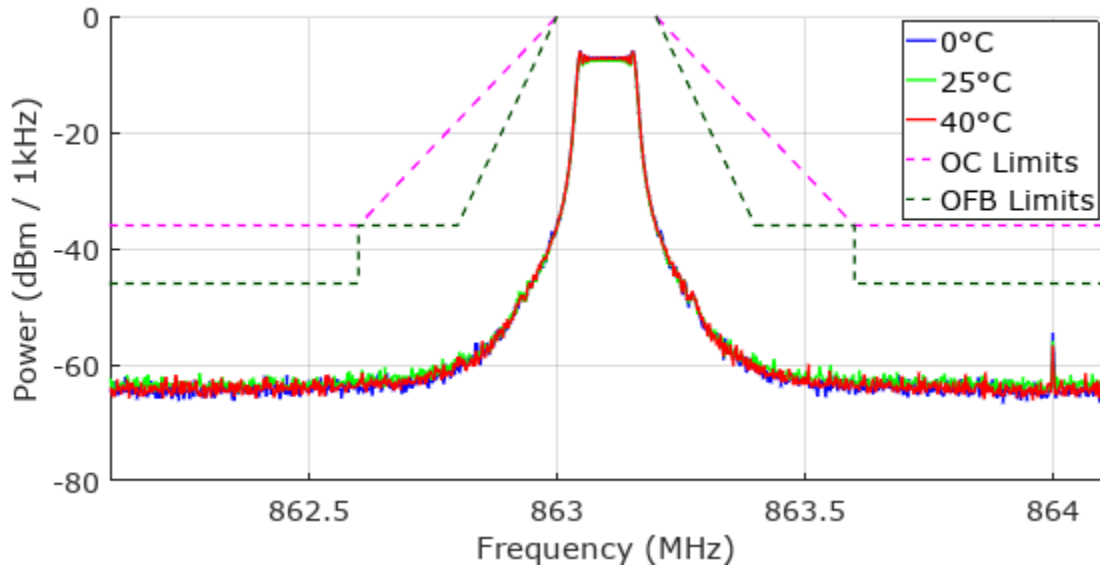

Figure 3-6: Out of Band Emissions - 863.1MHz Carrier

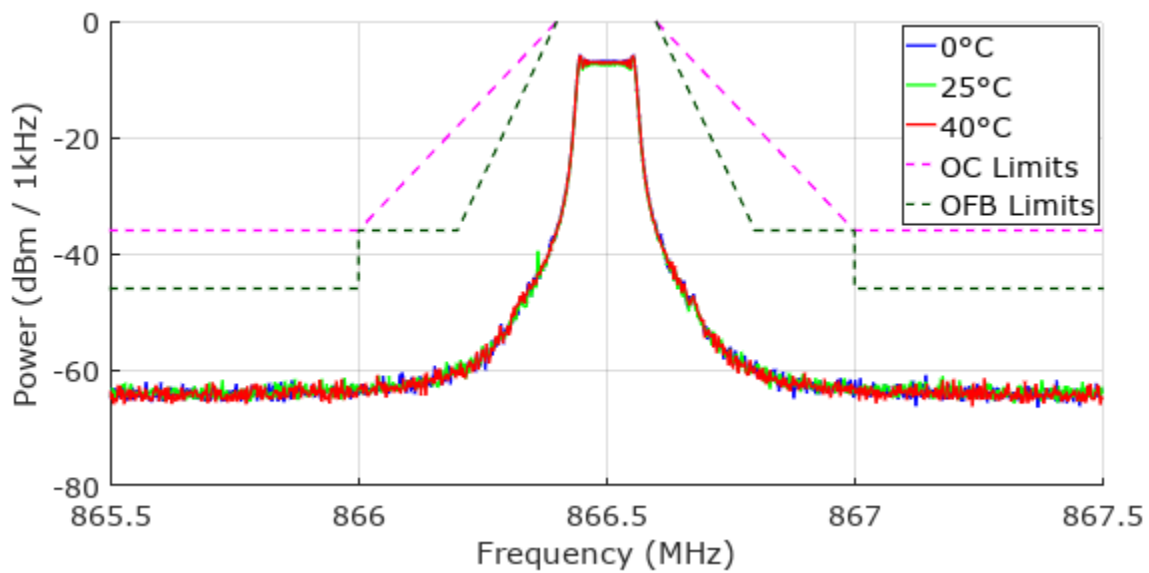

Figure 3-7: Out of Band Emissions - 866.5MHz Carrier

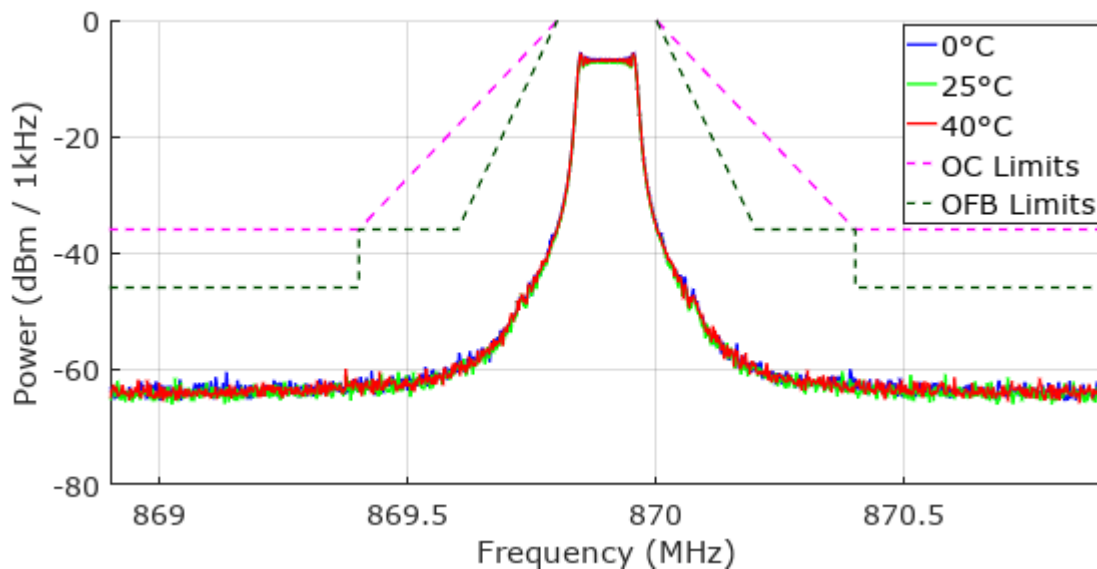

Figure 3-8: Out of Band Emissions - 869.9MHz Carrier

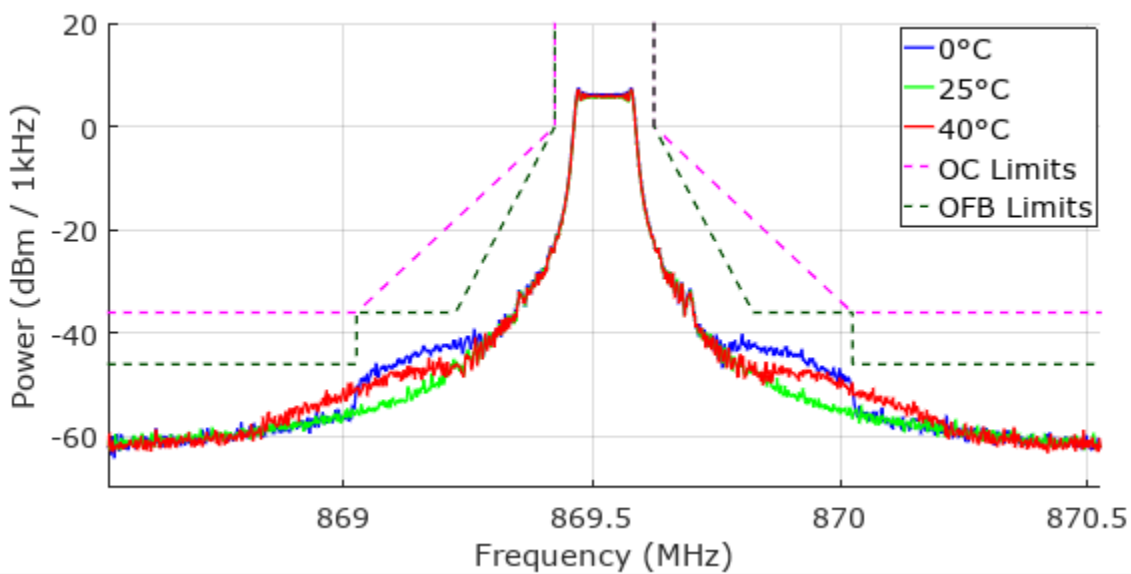

Figure 3-9: Out of Band Emissions – 27 dBm RX2 window, 869.525 MHz Carrier

3.6.3 Conclusions

The unit was found to be compliant with both Operational Channel (OC) and Operation Frequency Band (OFB) limits at the maximum rated power across temperature.

3.7 Unwanted Emissions in the Spurious Domain – Radiated Emissions

3.7.1 Test Description

Radiated emissions are will be conducted at a third party test lab. Test report t29e17a146-2 R1.

3.8 Unwanted Emissions in the Spurious Domain – Conducted Emissions

3.8.1 Test Description

This test will measure conducted unwanted emissions of the Kona Micro Gateway. Measurements are taken in accordance to ETSI EN 300 220-2 v3.1.1 section 5.9. The applicable limits are shown in Figure 3-8, Table 3-6 and Table 3-7.

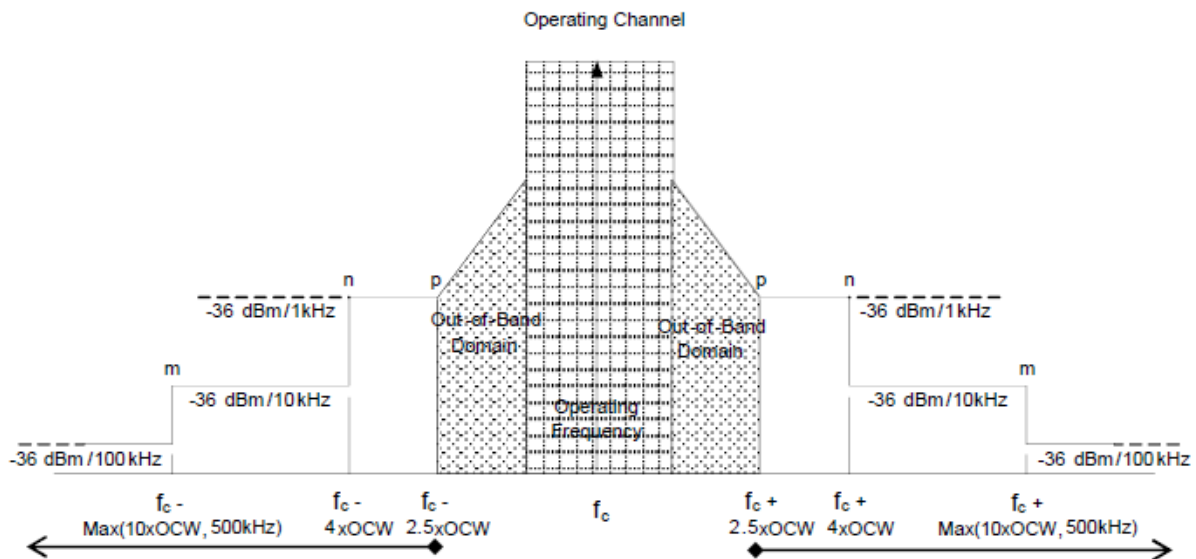

Figure 3-10: Spectrum Mask for Unwanted Emissions

Table 3-9: Spurious Domain Emission Limits

Frequency \ State	47 MHz to 74 MHz 87,5 MHz to 118 MHz 174 MHz to 230 MHz 470 MHz to 790 MHz	Other frequencies below 1 000 MHz	Frequencies above 1 000 MHz
TX mode	-54 dBm	-36 dBm	-30 dBm
RX and all other modes	-57 dBm	-57 dBm	-47 dBm

Table 3-10: Parameters for TX Spurious Measurements

Operating Mode	Frequency Range	RBW _{REF} (see note 2)
Transmit mode	$9 \text{ kHz} \leq f < 150 \text{ kHz}$	1 kHz
	$150 \text{ kHz} \leq f < 30 \text{ MHz}$	10 kHz
	$30 \text{ MHz} \leq f < f_c - m$	100 kHz
	$f_c - m \leq f < f_c - n$	10 kHz
	$f_c - n \leq f < f_c - p$	1 kHz
	$f_c + p < f \leq f_c + n$	1 kHz
	$f_c + n < f \leq f_c + m$	10 kHz
	$f_c + m < f \leq 1 \text{ GHz}$	100 kHz
	$1 \text{ GHz} < f \leq 6 \text{ GHz}$	1 MHz

NOTE 1: f is the measurement frequency.
 f_c is the Operating Frequency.
 m is 10 x OCW or 500 kHz, whichever is the greater.
 n is 4 x OCW or 100 kHz, whichever is the greater.
 p is 2,5 x OCW.

NOTE 2: If the value of RBW used for measurement is different from RBW_{REF}, use bandwidth correction from clause 4.3.10.1.

3.8.2 Results

3.8.2.1 Spurious Emissions (Tx mode and Rx mode)

Conducted measurements in the regions of Table 3-7 below 30MHz and above 3.7GHz were not measured due to MXA limitations.

Operating channel width (OCW) is 200 kHz so $m = 2 \text{ MHz}$.

The measurement region of $30\text{MHz} \leq f \leq f_c - m$ is shown in Figure 3-9. Measurements were taken with the transmitter active at 869.9 MHz (worst case).

Figure 3-10 covers all of the measurement regions between $f_c - m$ and $f_c + m$. Measurements were taken with the transmitter active at 863.1 MHz (worst case).

The measurement region of $f_c + m \leq f \leq 1\text{GHz}$ is shown in Figure 3-11. Measurements were taken with the transmitter active at 863.1 MHz (worst case).

Figure 3-12 shows the 1GHz to 6GHz region. Measurements were taken with the transmitter active at 863.1 MHz (worst case).

RX-only measurements are shown in Figure 3-13 through Figure 3-14.

Table 3-8 lists all detected spurs, along with the relevant emission limits and margin.

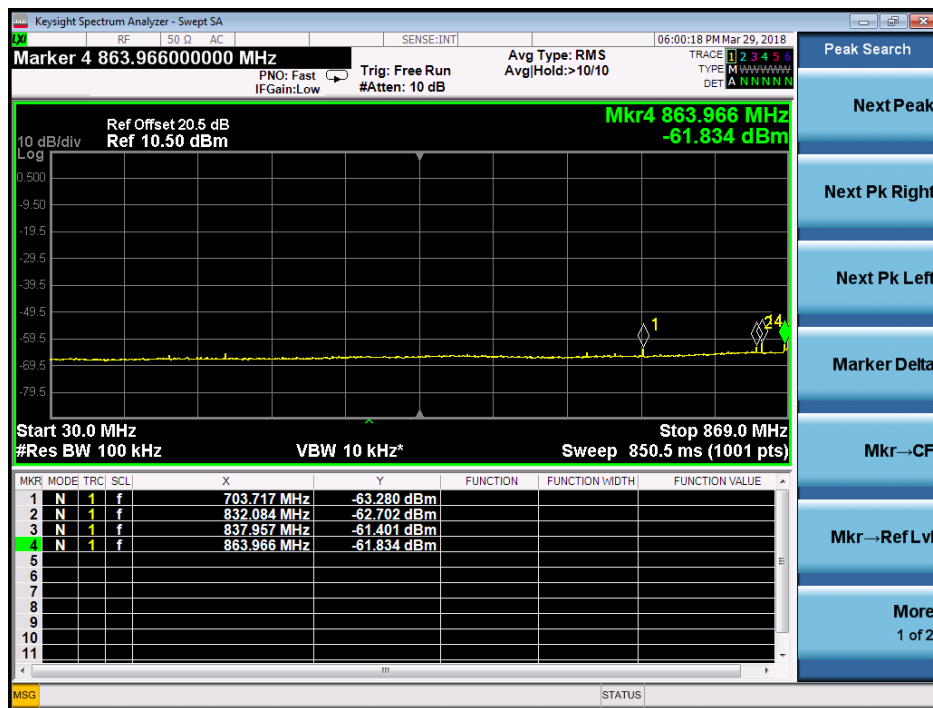

Figure 3-11: 30MHz to 869 MHz Spurious Emissions, 869.9 MHz Transmit Signal

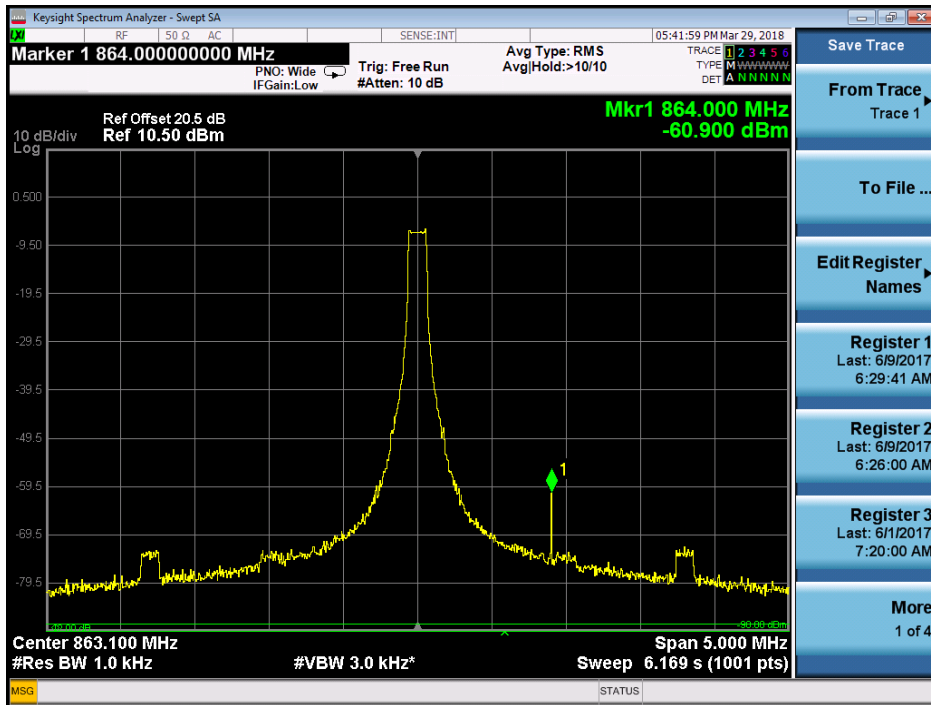

Figure 3-12: 860.6 MHz to 865.6 MHz Spurious Emissions, 863.1 MHz Transmit Signal

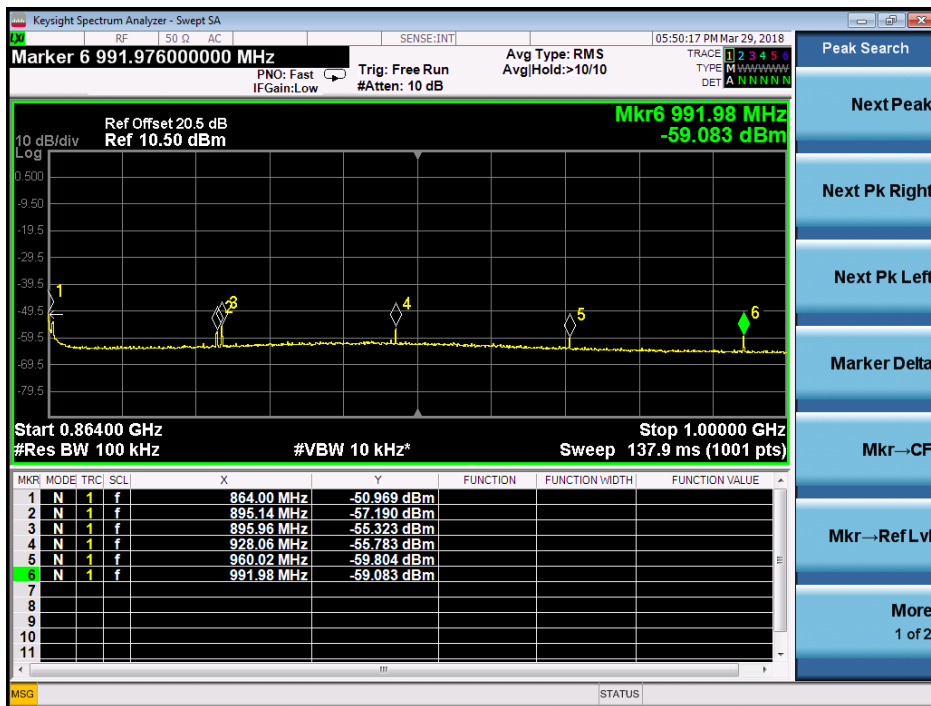

Figure 3-13: 864 MHz to 1 GHz Spurious Emissions, 863.1 MHz Transmit Signal

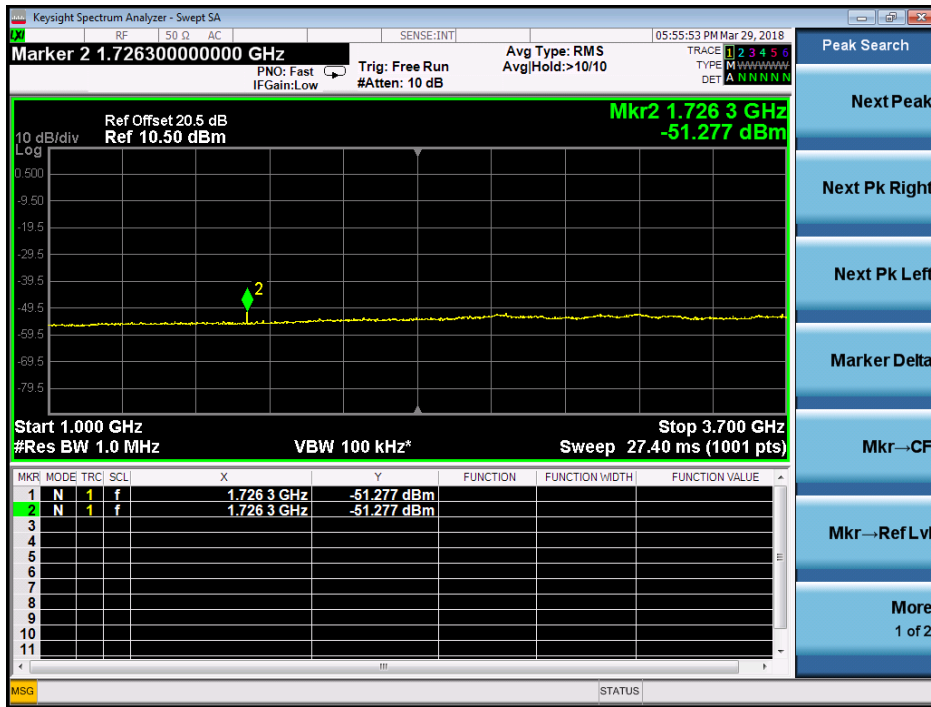

Figure 3-14: 1 GHz to 3.7 GHz Spurious Emissions, 863.1 MHz Transmit Signal

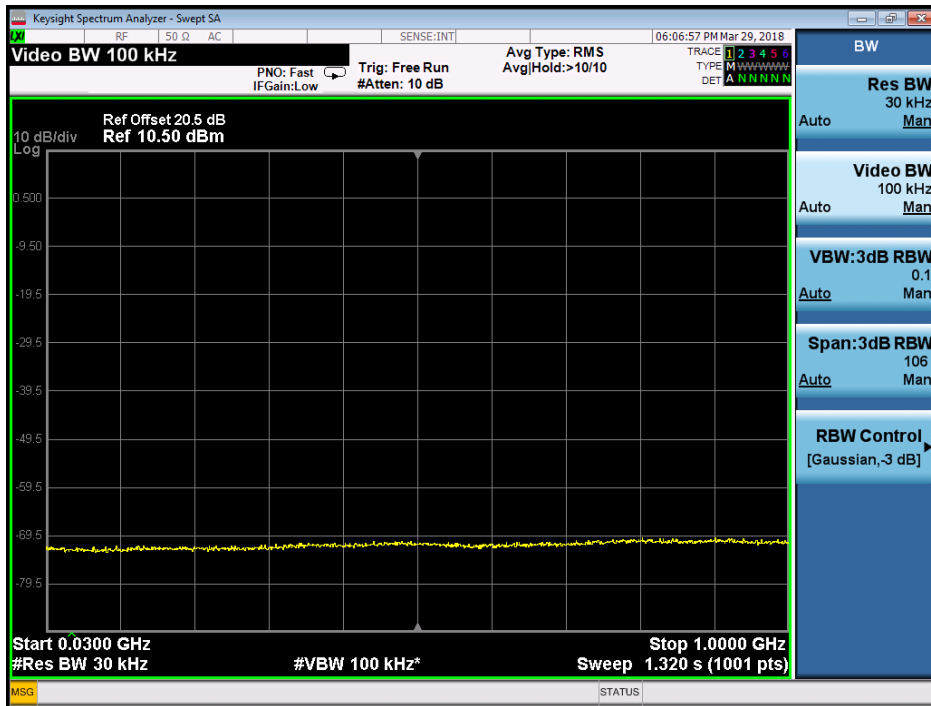

Figure 3-15: 30MHz to 1 GHz Spurious Emissions, RX Only



Figure 3-16: 1 GHz to 3.7 GHz Spurious Emissions, RX Only

Table 3-11: Summary of Detected Spurs

Frequency Range	Resolution Bandwidth (kHz)	Spur Frequency (MHz)	Spur Power (dBm)	Limit (dBm)	Margin (dB)
$30\text{MHz} \leq f \leq f_c - m$	100	704	-63.3	-54	9.3
$30\text{MHz} \leq f \leq f_c - m$	100	832	-62.7	-36	26.7
$30\text{MHz} \leq f \leq f_c - m$	100	838	-61.4	-36	25.4
$30\text{MHz} \leq f \leq f_c - m$	100	864	-61.8	-36	25.8
$f_c - m \leq f \leq f_c + m$	1	864	-51.0	-36	15.0
$f_c + m \leq f \leq 1\text{ GHz}$	100	895	-57.2	-36	21.2
$f_c + m \leq f \leq 1\text{ GHz}$	100	896	-55.3	-36	19.3
$f_c + m \leq f \leq 1\text{ GHz}$	100	928	-55.8	-36	19.8
$f_c + m \leq f \leq 1\text{ GHz}$	100	960	-59.8	-36	23.8
$f_c + m \leq f \leq 1\text{ GHz}$	100	992	-59.1	-36	23.1
$1\text{ GHz} < f \leq 6\text{GHz}$	1000	1726	-51.3	-30	21.3

Table 3-12: Summary of Detected Spurs – RX2 Window

Frequency Range	Resolution Bandwidth (kHz)	Spur Frequency (MHz)	Spur Power (dBm)	Limit (dBm)	Margin (dB)
$30\text{MHz} \leq f \leq f_c - m$	100	832.2	-57.0	-36	21.0
		843.96	-60.3	-36	24.3
$f_c - m \leq f \leq f_c + m$	1	868.81	-58.5	-36	22.5
$f_c + m \leq f \leq 1 \text{ GHz}$	100	875.11	-52.5	-36	16.5
		895.94	-53.0	-36	17.0
		901.46	-54.0	-36	18.0
		906.98	-52.5	-36	16.5
		927.93	-54.0	-36	18.0
$1 \text{ GHz} < f \leq 6\text{GHz}$	1000	5650	-47.3	-30	17.3

3.8.3 Conclusions

The Micro Gateway is compliant with unwanted emissions limits.

3.9 Transient Power

3.9.1 Test Description

This test will measure transient power characteristics when the transmitter is turning on and off.

Measurements are taken in accordance to ETSI EN 300 220-2 v3.1.1 section 5.10.

Transient power limits are shown in Table 3-9.

Table 3-13: Transmitter Transient Power Limits

Absolute offset from centre frequency	RBW_{REF}	Peak power limit applicable at measurement points
$\leq 400 \text{ kHz}$	1 kHz	0 dBm
$> 400 \text{ kHz}$	1 kHz	-27 dBm

Offsets and RBW requirements are shown in Table 3-10.

Table 3-14: Transient Power Measurement Parameters

Measurement points: offset from centre frequency	Analyser RBW	RBW_{REF}
-0,5 x OCW - 3 kHz 0,5 x OCW + 3 kHz Not applicable for OCW < 25 kHz	1 kHz	1kHz
±max (12,5 kHz, OCW)	Max (RBW pattern 1,3,10) ≤ Offset frequency/6 (see note)	1 kHz
-0,5 x OCW - 400 kHz 0,5 x OCW + 400 kHz	100 kHz	1 kHz
-0,5 x OCW -1 200 kHz 0,5 x OCW + 1 200 kHz	300 kHz	1 kHz
<p>NOTE: Max (RBW pattern 1, 3, 10) means the maximum bandwidth that falls onto the commonly implemented 1,3,10 RBW filter bandwidth incremental pattern of spectrum analysers.</p> <p>EXAMPLE: If OCW is 25 kHz then the RBW value corresponding to one OCW offset frequency is 3 kHz. The rest of the analyser settings are listed in Table 25, and if OC is 250 kHz then the RBW value corresponding to one OCW offset frequency is 30 kHz.</p>		

3.9.2 Results

Measurements were taking in single carrier mode at a transmit frequency of 863.1 and 869.9 MHz. OCW is 200 kHz.

Table 3-15: Transient Power Results

Signal Freq (MHz)	Offset	Freq (MHz)	RBW (kHz)	Measured Peak (dBm)	Peak in RBW_ref (dBm)	Limit (dBm)	Margin (dB)
863.1	-0.5 x OCW - 3kHz	862.997	1	-29.4	-29.4	0	29.4
	0.5 x OCW + 3kHz	863.203	1	-32.5	-32.5	0	32.5
	-0.5 x OCW - 400kHz	862.6	100	-32.4	-52.4	-27	25.4
	0.5 x OCW + 400kHz	863.6	100	-31.8	-51.8	-27	24.8
	-0.5 x OCW - 1200kHz	861.8	300	-36.4	-61.2	-27	34.2
	0.5 x OCW + 1200kHz	864.4	300	-35.9	-60.7	-27	33.7
	-OCW	862.9	10	-34	-44.0	0	44.0
	OCW	863.3	10	-32.7	-42.7	0	42.7
869.9	-0.5 x OCW - 3kHz	869.797	1	-33.2	-33.2	0	33.2
	0.5 x OCW + 3kHz	870.003	1	-32.7	-32.7	0	32.7
	-0.5 x OCW - 400kHz	869.4	100	-31.8	-51.8	-27	24.8
	0.5 x OCW + 400kHz	870.4	100	-31.3	-51.3	-27	24.3
	-0.5 x OCW - 1200kHz	868.6	300	-36.1	-60.9	-27	33.9
	0.5 x OCW + 1200kHz	871.2	300	-35.8	-60.6	-27	33.6
	-OCW	869.7	10	-30.5	-40.5	0	40.5
	OCW	870.1	10	-34	-44.0	0	44.0

Table 3-16: Transient Power Results - RX2 Window

Signal Freq (MHz)	Offset	Freq (MHz)	RBW (kHz)	Measured Peak (dBm)	Peak in RBW_ref (dBm)	Limit (dBm)	Margin (dB)
869.525	-0.5 x OCW - 3kHz	869.422	1	-21.8	-21.8	0	21.8
	0.5 x OCW + 3kHz	869.628	1	-21.8	-21.8	0	21.8
	-0.5 x OCW - 400kHz	869.025	100	-37.8	-57.8	-27	30.8
	0.5 x OCW + 400kHz	870.025	100	-37.5	-57.5	-27	30.5
	-0.5 x OCW - 1200kHz	868.225	300	-42	-66.8	-27	39.8
	0.5 x OCW + 1200kHz	870.825	300	-42.1	-66.9	-27	39.9
	-OCW	869.325	10	-26.6	-36.6	0	36.6
	OCW	869.725	10	-29.3	-39.3	0	39.3

3.9.3 Conclusions

Transient power measurements are all compliant with significant margin.

3.10 Adjacent Channel Power

This test is not applicable since the OCW is greater than 25kHz.

3.11 TX Behaviour under Low Voltage Conditions

This test is not applicable since this the Gateway is not a battery powered device.

3.12 Adaptive Power Control

This test is not applicable since this the Gateway does not use adaptive power control.

3.13 FHSS Equipment

This test does not apply as the Gateway is not FHSS.

3.14 Short Term Behaviour

This test does not apply as Duty Cycle is not tested at the Gateway and is under Network Server control.

3.15 RX Sensitivity

3.15.1 Test Description

This test will measure the RX sensitivity of the Gateway.

Measurements are taken in accordance to ETSI EN 300 220-2 v3.1.1 section 5.14.

The limits for sensitivity are defined in Table 3-12.

Table 3-17: Limits for Receiver Sensitivity

$S = 10 \log RB_{kHz} - 4 \text{ dB}\mu V \text{ emf}; \text{ or}$ $S_p = 10 \log RB_{kHz} - 117 \text{ dBm}$ <p>where:</p> <ul style="list-style-type: none">• S_p is the sensitivity in dBm.• RB is the declared receiver bandwidth in kHz.

For operation in the EU ISM band the receiver supports bandwidths of 125-500 kHz. This results in a sensitivity level of $S_p = -96\text{dBm}$ for 125 kHz bandwidth and -90dBm for 500 kHz bandwidth.

For LoRa, the general benchmark for sensitivity is a Packet Error Rate (PER) of 10%. Sensitivity was measured for LoRa spreading factors 7 and 10. For each measurement 100 packets were sent and PER was determined as:

$$\text{PER} = 1 - \frac{\text{\# of successfully received packets}}{\text{\# of packets sent}}$$

3.15.2 Results

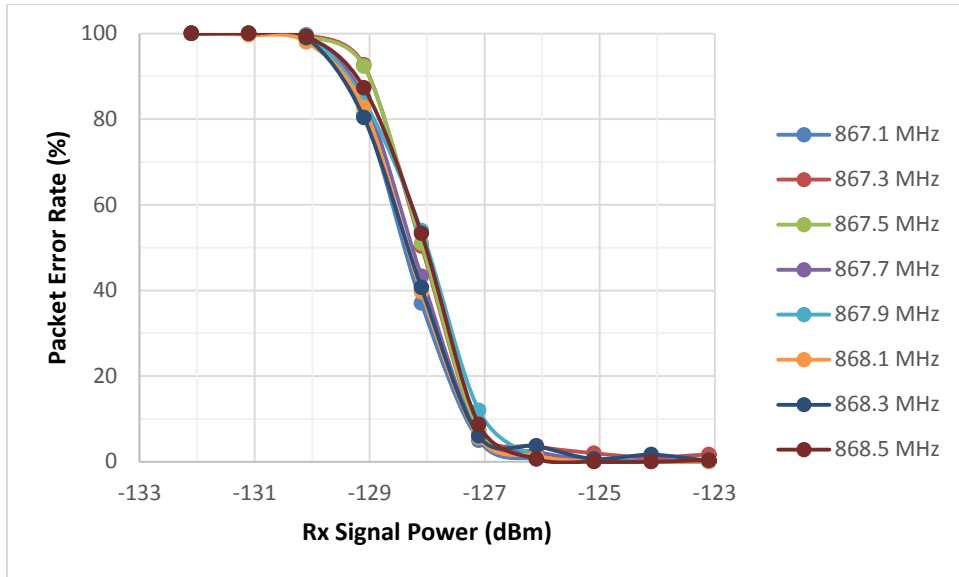

Figure 3-17: Rx Sensitivity, 125 kHz SF7

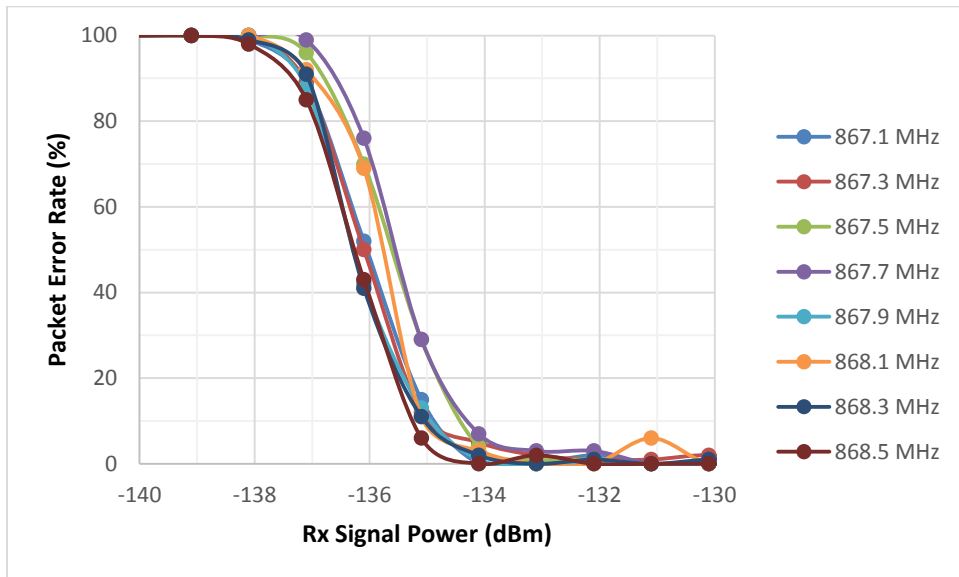

Figure 3-18: Rx Sensitivity, 125 kHz SF10

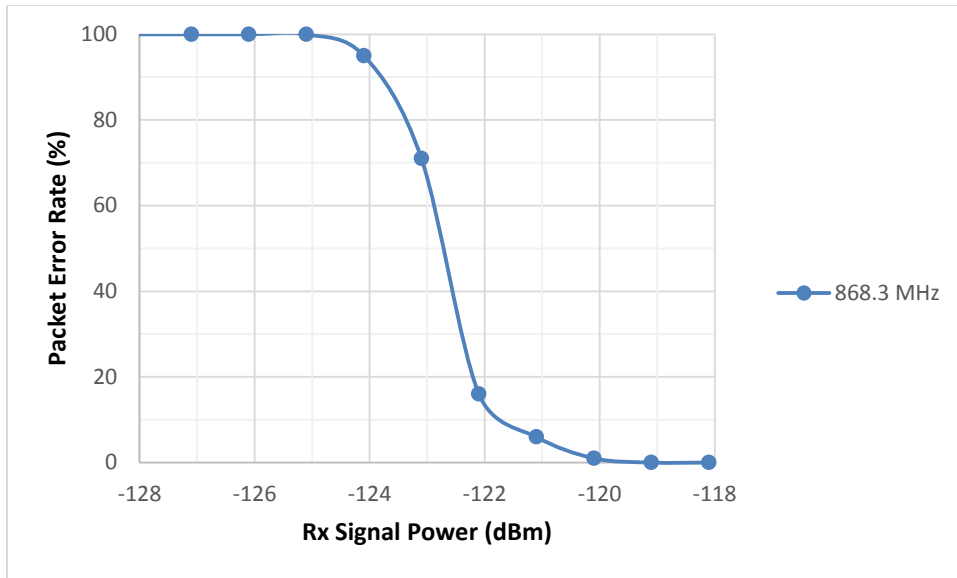

Figure 3-19: Rx Sensitivity, 500 kHz SF7

3.15.3 Conclusions

The Micro Gateway easily meets the criteria for sensitivity at both 125 kHz and 500 kHz bandwidths.

3.16 Adjacent Channel Selectivity

Not applicable.

3.17 Receiver Saturation

Not applicable.

3.18 Spurious Response Rejection

Not applicable.

3.19 Behaviour at High Wanted Signal Level

Not applicable.

3.20 Blocking

3.20.1 Test Description

This test will measure the blocking on the Gateway receiver.

Measurements are taken in accordance to ETSI EN 300 220-2 v3.1.1 section 5.18.

Testing of the Kona Micro Gateway will be to RX category 1.5 outlined in Table 3-13.

Table 3-18: Blocking Level Parameters for RX Category 1.5

Requirement	Limits
	Receiver category 1.5
Blocking at ± 2 MHz from OC edge f_{high} and f_{low}	≥ -43 dBm
Blocking at ± 10 MHz from OC edge f_{high} and f_{low}	≥ -33 dBm
Blocking at ± 5 % of Centre Frequency or 15 MHz, whichever is the greater	≥ -33 dBm

As described in ETSI EN 300 220-2 v3.1.1 section 5.18, the input power of the desired signal was set to the minimum sensitivity level requirement of $-96\text{dBm} + 3\text{dB}$. For each measurement 1000 packets were sent.

3.20.2 Results

Table 3-19: Blocking Performance

Signal Frequency (MHz)	Blocker Frequency (MHz)	Blocker Power (dBm)	Packet Error Rate (%)
867.5	865.5	-33	0.2
867.5	869.5	-33	0
867.5	857.5	-23	0
867.5	877.5	-23	0.2
867.5	824.125	-23	0.2
867.5	910.875	-23	0.1

3.20.3 Conclusions

A blocker 10dB higher than those required of category 1.5 was used and was shown to have no significant effect on packet reception. The highest PER rate seen of 0.2% is well below the minimum PER floor expected for LoRa receivers. This test is therefore compliant for a category 1.5 receiver.

4 Summary

Table 4-1: Compliance Summary

EN 300 220-2 Section	Pass/Fail	Comments
4.2 Unwanted Emissions in the spurious domain	Pass	
4.3.1 Effective Radiated Power	Pass*	Manual gain adjustment needed across temperature.
4.3.2 Maximum E.R.P Spectral Density	Pass*	Conforming power level identified. Applicability still to be determined.
4.3.3 Duty Cycle	N/A	
4.3.4 Occupied Bandwidth	Pass	
4.3.5 Tx Out of Band Emissions	Pass	
4.3.6 Transient Power	Pass	
4.3.7 Adjacent Channel Power	N/A	
4.3.8 TX Behaviour under Low Voltage Conditions	N/A	
4.3.9 Adaptive Power Control	N/A	
4.3.10 FHSS Equipment	N/A	
4.3.11 Short Term Behaviour	N/A	
4.4.1 RX Sensitivity	Pass	
4.4.2 Blocking	Pass	
4.5 Polite Spectrum Access Conformance Requirement	N/A	