



TEKTELIC Communications Inc.
7657 10th Street NE Calgary, Alberta
Canada, T2E 8X2

USER GUIDE

Document Type:	User Guide
Document Number:	T0006377_UG
Document Version:	0.6
Product Name:	Meeting Room Display Tablet
Product Codes & Revisions:	T0006086 –Battery Powered Digital Signage, NA T0006093 – Externally Powered Digital Signage, NA T0006749 –Battery Powered Digital Signage, EU T0006750 – Externally Powered Digital Signage, EU
Issue Date:	April 20, 2020

Revision History

Version	Date	Editor	Comments
0.1	July 17, 2019	Emma Tholl	Initial Draft.
0.2	November 7, 2019	C Karperien	General updates and template updates
0.3	November 25, 2019	A Narayanan	Updated to include Tablet specific instructions.
0.4	December 5, 2019	C Karperien	General Updates and addition of Firmware Upgrade Feature
0.5	March 2, 2015	A. Narayanan	Updated Tcodes in Table 1 and Temperature specification in Table 2
0.6	April 20, 2020	C Karperien	Changes to Firmware Upgrade section

Table of Contents

List of Tables	4
List of Figures	5
1 Product Description	6
1.1 Overview	6
1.2 Specifications.....	8
1.3 Physical Interfaces.....	9
2 Commissioning	11
2.1 Power Up/Down Procedure	11
3 Installation	12
3.1 Included Product and Installation Material	12
3.2 Safety Precautions.....	12
3.3 Unpacking and Inspection	12
3.4 Equipment Required for Installation.....	13
3.5 Meeting Room Display Tablet mounting	13
3.6 Battery Replacement.....	15
4 Graphical User Interface.....	16
4.1 Available	16
4.2 Occupied.....	18
5 Operation, Alarms, and Management.....	20
5.1 Configuration.....	20
5.2 Default Configuration.....	20
5.3 LED Behaviour	20
6 Firmware Upgrade Feature	21
6.1 Overview	21
6.2 Setup/Requirements	21
6.3 Steps to Complete Firmware Upgrade.....	22
7 Compliance Statements.....	26
8 Bibliography.....	28

List of Tables

Table 1: Meeting Room Display Tablet Models 6
Table 2: Meeting Room Display Tablet Specifications 8

List of Figures

- Figure 1-1: Meeting Room Display Tablet 7
- Figure 1-2: The Tablet (external) interface layout..... 9
- Figure 1-3: The Tablet (Battery) interface layout. 10
- Figure 2-1: Meeting Room Display Tablet’s infrastructure..... 11
- Figure 3-1: Wall mount plate. 14
- Figure 3-2: Tablet back side 15
- Figure 4-1: Room Available – User interface flow 17
- Figure 4-2: Room Occupied state..... 18
- Figure 4-3: Room Occupied –User interface flow..... 19
- Figure 6-1 USB A to Micro-B Cable 21
- Figure 6-2 Digital Signage Board with power plug and USB cable connected 21
- Figure 6-3 Com Power Selection..... 22
- Figure 6-4 Serial Port and Speed Selection..... 22
- Figure 6-5 Ready for Firmware Note 23
- Figure 6-6 Progress Bar 23
- Figure 6-7 Firmware file upload aborted 24
- Figure 6-8 Firmware upgrade successful 24

1 Product Description

1.1 Overview

The Meeting Room Display Tablet is a LoRaWAN enabled interactive signboard. The Digital Sign features 6" E Ink screen with capacitive touch, Front light, RGB LED indicators, Accelerometer and Battery monitor. Table 1 presents the Meeting Room Display Tablet models.

Table 1: Meeting Room Display Tablet Models

Product Code	Description	RF Region	Tx Band (MHz)	Rx Band (MHz)
T0006086	MODULE, DIGITAL SIGNAGE, BATTERY POWERED, NA	US915	923-928	902-915
T0006093	MODULE, DIGITAL SIGNAGE, EXTERNALLY POWERED, NA	US915	923-928	902-915
T0006749	MODULE, DIGITAL SIGNAGE, BATTERY POWERED, EU	EU868	863-870	863-870
T0006750	MODULE, DIGITAL SIGNAGE, EXTERNALLY POWERED, EU	EU868	863-870	863-870

The main features of the Meeting Room Display Tablet (Tablet) are the following:

- **6" E Ink screen:** 1024(H) x 758(V) pixels with 16 levels of gray.
- **Touch screen:** Capacitive touch screen.
- **Front light:** Uniform front lighting for low light environment.
- **LED:** Configurable RGB LEDs provide an indication of the room status that are visible from a distance.
- **LoRa:** Air interface capable of long range at low power.
- **Battery Powered (option):** Powered by 4xAAA, Up to 1-year battery life.
- **Externally Powered (option):** 5V DC or PoE (48V) powering option.
- **Easy Installation:** Removable wall mount plate simplifies the installation and alignment of the Tablet.
- **Safety Screw:** Hidden screw on the top that requires a special tool to unlock ensuring the devices safety.

- **Hidden Cables:** If powering the device externally there are grooves to hide the cables leaving a clean finish.
- **Landscape or Portrait mode¹:** The device can be mounted in horizontal or vertical orientation.
- **Battery Monitor:** Monitors the battery level and provides a low battery warning for timely replacement.
- **Deep Sleep mode:** Accelerometer allows the device to save power when the Tablet is not in use and wake up on when a Double-tap is detected on the screen.

Figure 1-1 illustrates the Meeting Room Display Tablet.



Figure 1-1: Meeting Room Display Tablet

¹ Portrait mode is not supported in current version of firmware

1.2 Specifications

The Meeting Room Display Tablet specifications are listed in Table 2.

Table 2: Meeting Room Display Tablet Specifications

Attribute	Specification
Use Environment	Indoor only
Enclosure	Plastic, IP30
Operating Temperature	5°C to 40°C
Storage Temperature	-25°C to 70°C
Operating Relative Humidity	5% to 95%, condensing
Size	4.5 (L) x 6 (W) x 1(H) inch
Weight	340g(0.75lb) with batteries 280g(0.62lb) without batteries
Display	Size: 6-inch E Ink screen (3:4) Resolution: 1024(H) x 758(V) pixels Color: 16 levels of gray (monochrome) Front light
Touch screen	Capacitive touch screen ± 5 mm accuracy
Power Source	Externally powered Option: -DC 5V -PoE 48VDC (IEEE 802.3af Mode A or B or 4-pair Mode) Battery powered option: -4x AA Lithium Batteries -Front light and RGB LEDs not supported
Power Consumption	3 W maximum
Battery Lifetime	1-year battery life for typical use case ²
Network technology/Frequency band	LoRaWAN in several variants (Table 1): US915, EU868
Air Interface	LoRa
Maximum Tx Power	15 dBm
LED	4 uniformly illuminated LED bars (RGB) Green: Available

² Active 10 hour/ week day (280 Rx packets, 15 Tx packets at 15dBm, 15 screen updates), in Deep sleep otherwise

	Red: Occupied
Ethernet	TBD
USB MicroB	USB2.0 Debug port
Temperature Measurement Accuracy	< $\pm 5^{\circ}\text{C}$

1.3 Physical Interfaces

Figure 1-2 and Figure 1-3 illustrates the customer accessible interfaces of the Tablet. All models share the same layout; however some functions are not available in some models. The externally powered model shown in Figure 1-2 has RGB LEDs on the corners while the battery powered version shown in Figure 1-3 cannot use the LEDs.

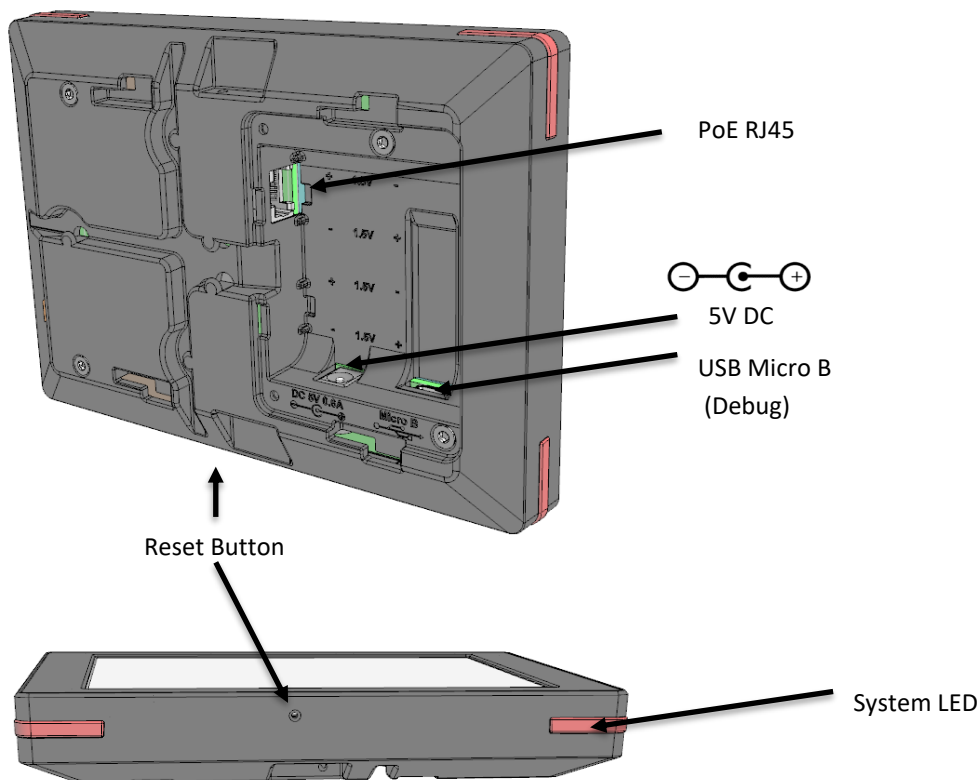

Figure 1-2: The Tablet (external) interface layout.

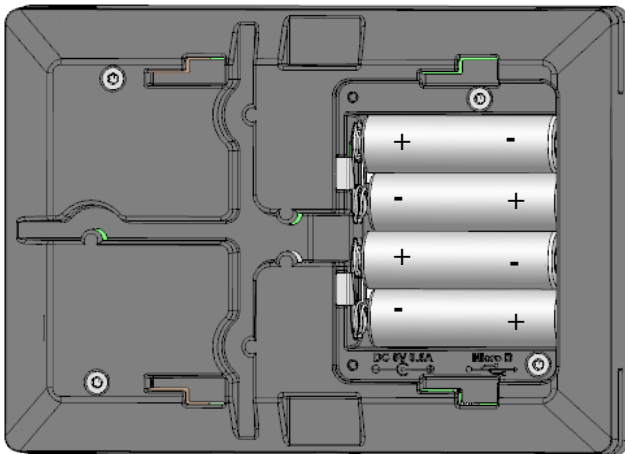
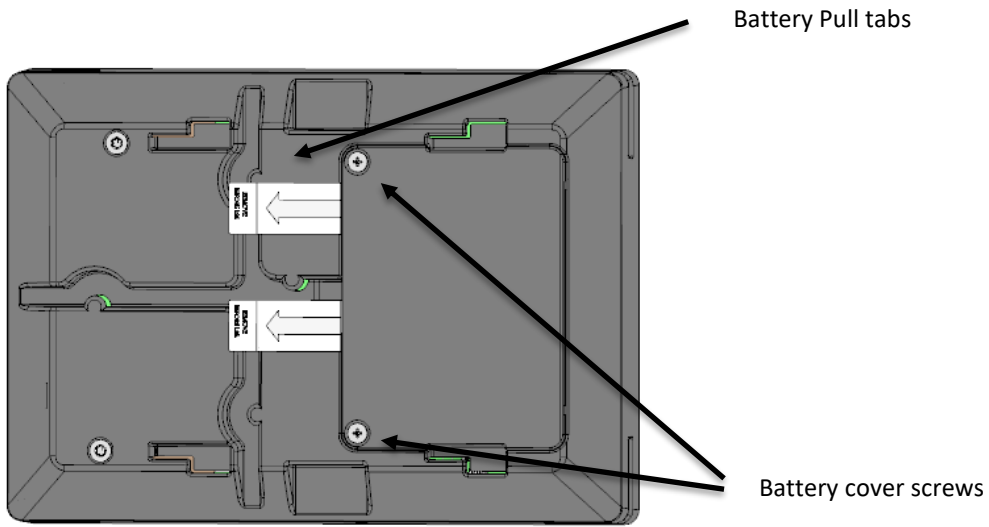

Figure 1-3: The Tablet (Battery) interface layout.

2 Commissioning

The steps for commissioning the Meeting Room Display Tablet are managed through a versatile Book Now Application (BNA) [1]. BNA provides an interface that guides the user through the steps to commission the Tablet and allocating it to a meeting room. BNA registers the Tablet onto the Network server using the unique identifier (EUI) of the Tablet. A high-level diagram of the Meeting Room Display Tablet's infrastructure is shown in Figure 2-1. It is recommended to refer to the BNA user guide [1] for detailed instructions on commissioning the Tablet.

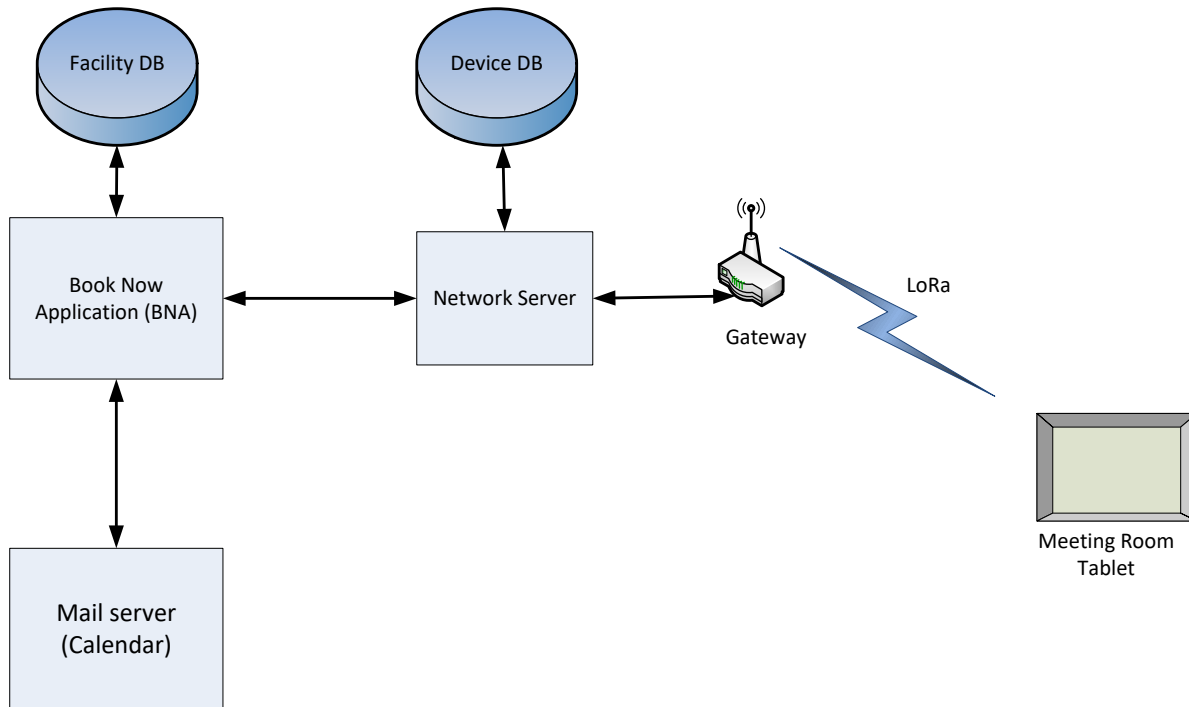

Figure 2-1: Meeting Room Display Tablet's infrastructure

2.1 Power Up/Down Procedure

- Battery powered version of Tablet is shipped with the batteries installed along with pull tabs that prevent the Tablet from turning on during shipment.
- Once the Tablet is configured on the BNA, turn on the Tablet by removing the battery pull tabs or providing external power depending on the model.
- See section 5.3 for LED behaviour during boot-up.
- To turn off the Tablet the batteries or external power must be removed. The unit must remain un-powered for 1 minute to completely reset.
- The reset switch of the Tablet is accessible through a pin hole in the bottom side of the Tablet as shown in Figure 1-2. See section 5.3 for LED behaviour during boot-up.

3 Installation

3.1 Included Product and Installation Material

The following items are shipped with each Tablet:

- Meeting Room Display Tablet
- 5V AC-DC power adapter (optional)
- Four AA batteries (optional)
- Wall mount plate
- Security/Lock screw (T6)
- Product Manual

3.2 Safety Precautions

The following safety precautions should be observed:

- The Tablet is for indoor use only. Do not connect Tablet to any outdoor cables.
- The Tablet has no internal field serviceable parts other than the batteries. Other than installing or replacing the batteries, the Tablet must only be opened by an approved TEKTELIC service center.
- All installation practices must be in accordance with the local and national electrical codes.
- Ensure that the Tablet is located to eliminate any physical hazard to people or property.
- The Tablet shall be powered from the supplied AC-DC power adaptor or through Power over Ethernet (PoE) or 4xAA batteries. Simultaneous application of power through more than one input may result in unexpected operation and shall be avoided.
- Keep batteries away from the reach of children.
- Do not mix old and new batteries.
- If the Tablet is not expected to be used for extended periods of time, the batteries should be removed before storage to avoid any leak.

3.3 Unpacking and Inspection

The following should be considered during the unpacking of a new Meeting Room Display Tablet:

- Inspect the shipping carton and report any significant damage to TEKTELIC.
- Unpacking should be conducted in a clean and dry location.

- Do not discard the shipping box or inserts as they will be required if a unit is returned for repair.

3.4 Equipment Required for Installation

The following tools are required to install the Meeting Room Display Tablet:

- 1) Screwdriver
- 2) 4x M4 Screws (Choose screw type based on mounting surface)
- 3) Spirit level
- 4) T6 Torx driver for the security/lock screw

3.5 Meeting Room Display Tablet mounting

Meeting Room Display Tablet features a removable mounting plate that simplifies the installation and leveling of the Tablet. Once the mount plate is installed the Tablet slides onto the four hooks on the plate. Tablet can be mounted in Landscape or Portrait ³mode.

Note: The mounting surface must be capable of holding > 15 kg [33 lbs].

Mounting the wall plate

- Thread the Ethernet and/or Power cables through the rectangular opening in the wall plate. Ensure that the lock screw feature marked as “C” in Figure 3-1 is facing away from the mounting surface.
- Secure the mount plate on the mounting surface using 4 x M4 screws in locations A or B as shown in the Figure 3-1.
 - Double sided adhesive tape could be used when mounting on glass
- The slots provided on mount plate allows for adjustment to level the mount plate.
- Using a spirit level, ensure that the mounting plate is plumb before tightening all the screws.

Connect cables

- With the externally powered version, connect the necessary cables to the Tablet (Ethernet, 5V DC and Debug USB port are accessible under the battery cover).
- No cables are required on the battery powered version.
- Cables can be routed through the channels on the back of the Tablet.

³ Portrait mode is not supported in current version of firmware

Install the Tablet

- Take a note of the MAC-ID/ EUI shown on the label on the back of the Tablet.
- To install the Tablet, first align the hooks on the mounting plate to the slots on the back of the Tablet (See features marked as “D” in Figure 3-1 and Figure 3-2), then push the Tablet onto the plate. Slide the Tablet to fix the Tablet in place.
- It is recommended to proceed with the commissioning steps detailed in Commissioning before completing the final step of securing the Tablet with the lock screw.

Secure the Tablet using the lock screw

- With the battery powered version, ensure that the battery shipment tabs are pulled out before securing the Tablet.
- A T6 Torx screw is provided for the security lock. Tighten the lock screw using hand to secure the Tablet.

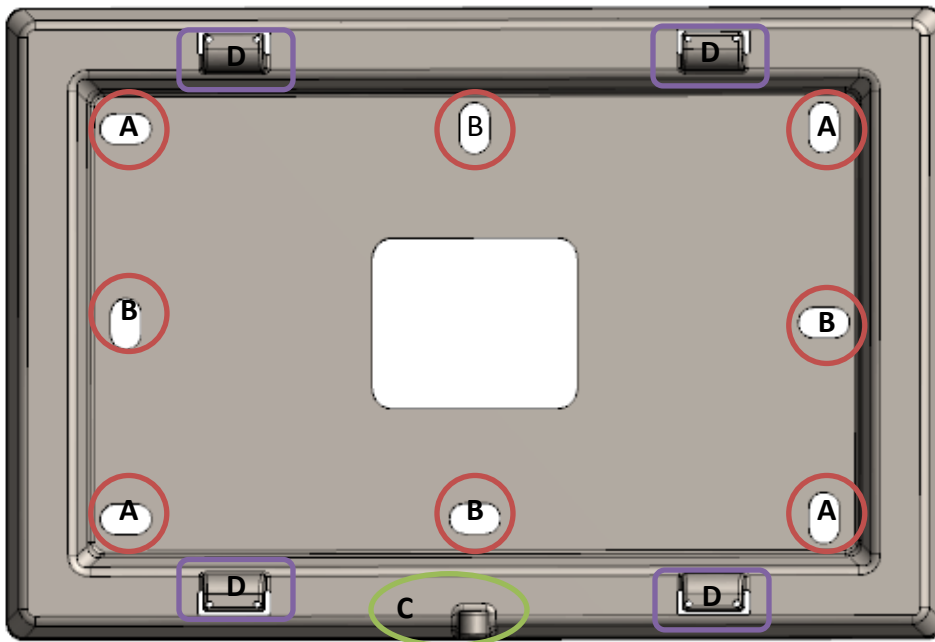

Figure 3-1: Wall mount plate.

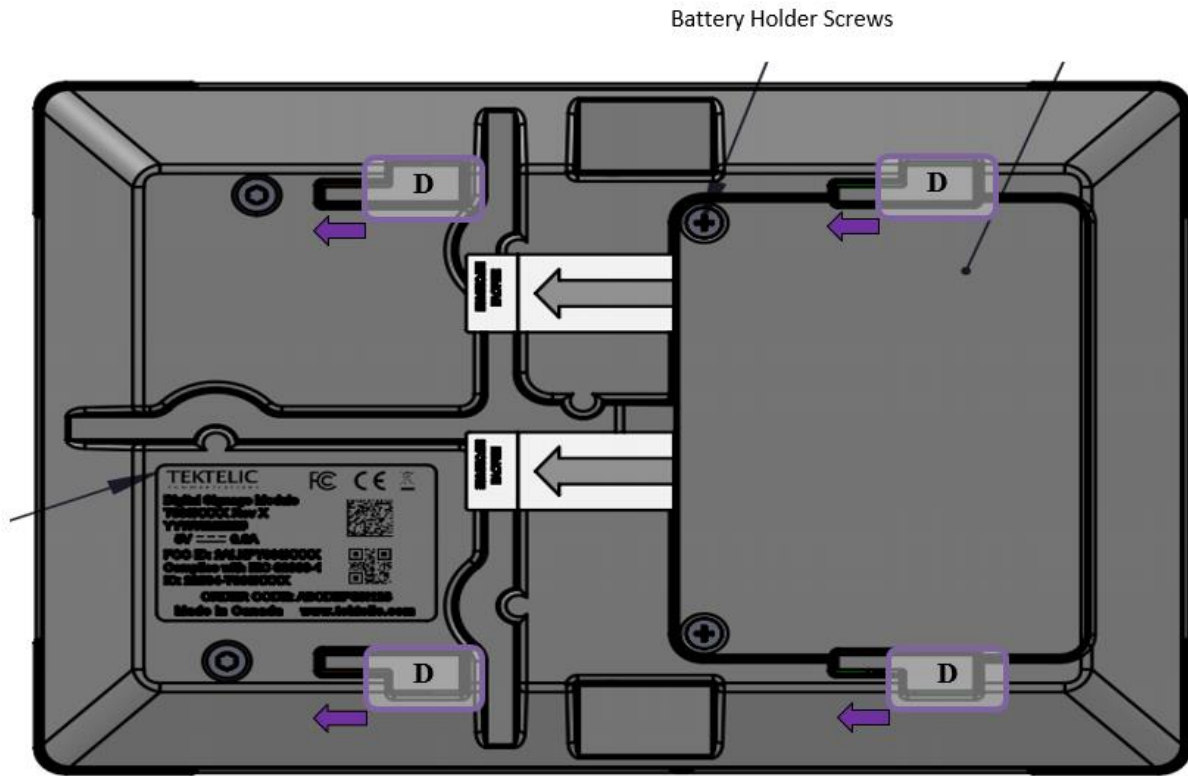

Figure 3-2: Tablet back side

3.6 Battery Replacement

The following tools are required to install the Meeting Room Display Tablet:

- 1) A Philips Screwdriver (#2)
- 2) 4x AA batteries (LiFES2 – Energizer, part number: L91)

Steps for replacing the batteries are as follows:

- Removed the battery cover by removing two philips screws shown in Figure 1-3
- Remove all the old batteries from the device.
- To turn off the device the batteries must be uninstalled and remain un-powered for 1 minute.
- Replace with all new batteries of the recommended type.
- Install the battery cover and philips screws to secure the batteries.
- See section 5.3 for LED behaviour during boot-up.
- Recycle the used batteries when possible by dropping them off at a participating retailer.

4 Graphical User Interface

The Meeting Room Display Tablet is equipped with a 6-inch EPD Touch Screen that enables users to book, extend or finish a meeting. The Tablet displays the details of current and next meeting for the room.

The graphical user interface (GUI) features are discussed next. The user interface flow can be divided into two tracks, one when the room is available for booking and one when the room is occupied.

4.1 Available

When the room is available for booking, the GUI uses a light background as shown in Figure 4-1. The LEDs light up with green color in the supported models. In Available state the GUI provides following options:

- Displays the Next meeting information: Meeting *start time* and *booked by*
- Button to book a meeting now for specified duration
 - Tablet makes the booking through a LoRa message to the BNA. The BNA ensures that the room is available for the specified duration and makes a booking in the configured calendar.
 - A confirmation message is displayed showing if the booking was successful or unsuccessful.

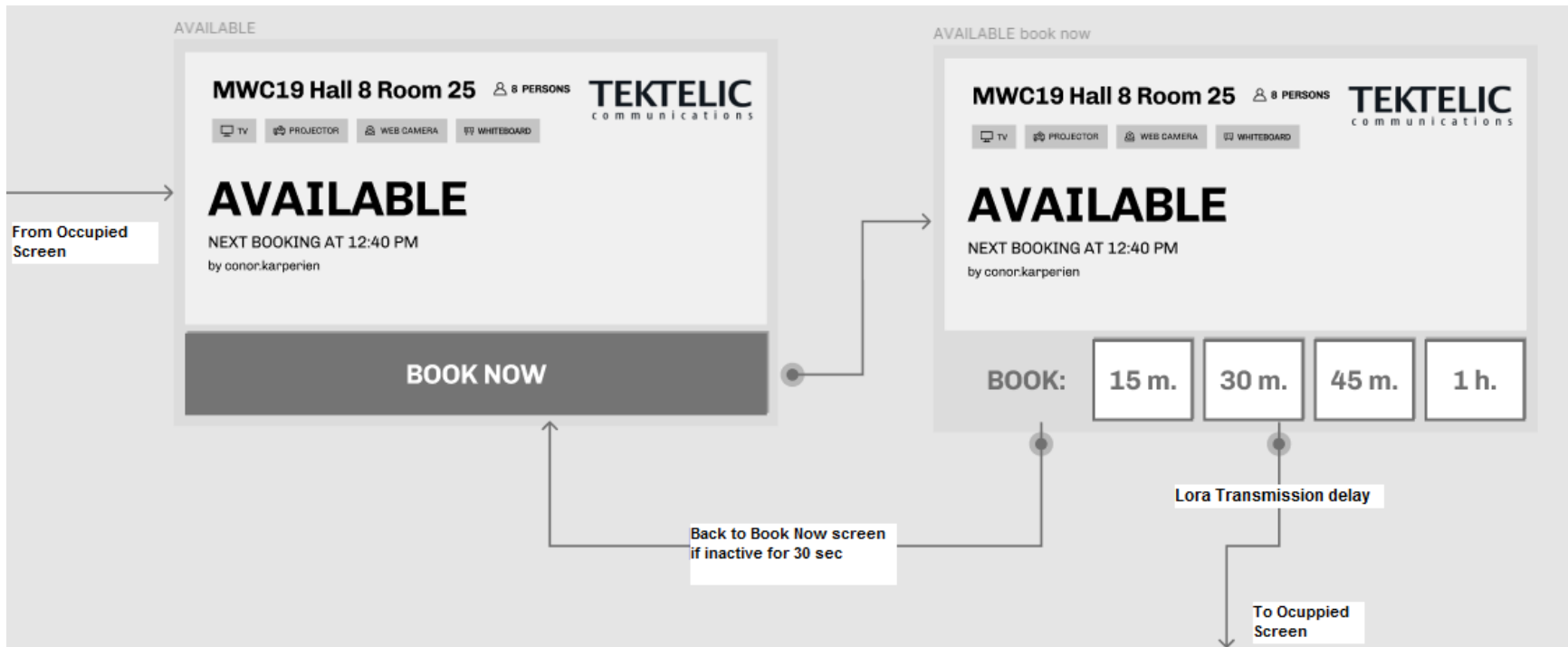

Figure 4-1: Room Available – User interface flow

4.2 Occupied

When the room is occupied, the GUI uses a dark background as shown in Figure 4-3. The LEDs light up with red color in the supported models.

In Occupied state the GUI provides following options:

- Displays the current meeting information: Meeting '*end time*' and '*booked by*'
- Displays the Next meeting information: Meeting '*start time*' and '*booked by*'
- Button to finish the current meeting.
- Button to extend the current meeting for a specified duration.
 - There must be at least 10 minutes in between bookings to be allowed to extend the current meeting.
- Button to book a meeting for next available time.
 - Tablet makes the booking through a LoRa message to the BNA. The BNA ensures that the room is available for the specified duration and makes a booking in the configured calendar.
 - A confirmation message is displayed showing if the booking was successful or unsuccessful.

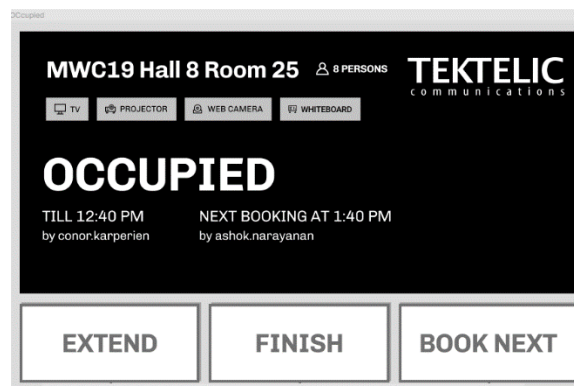

Figure 4-2: Room Occupied state

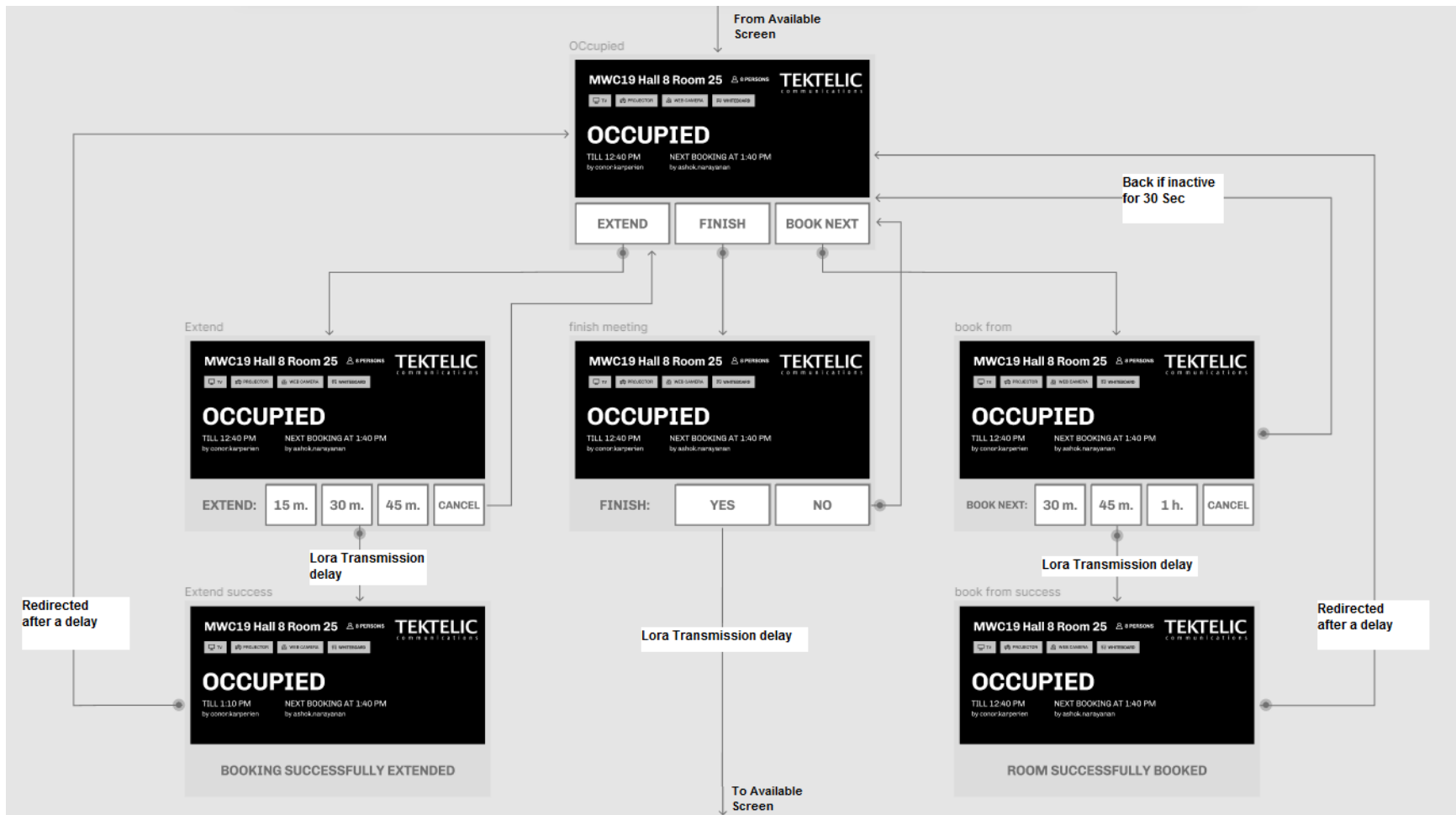

Figure 4-3: Room Occupied –User interface flow

5 Operation, Alarms, and Management

5.1 Configuration

The Meeting Room Display Tablet supports a range of Over-the-Air (OTA) configuration options. Specific technical details are available in the Technical Reference Manual [2] . All configuration commands need to be sent OTA during a Tablet's downlink windows.

5.2 Default Configuration

The default configuration on the Tablet is:

- Report the battery voltage every 1 (one) hour.
- For Class A mode operation query room status every 10 minutes.

5.3 LED Behaviour

Room Status LED (on externally powered variant)

All 4 LED bars turn green when the room is available for booking, and turns red when room is occupied.

System LED

The System LED shares the light pipe with the right bottom corner RGB LED.

During the boot and join procedure:

- The System LED will blink continuously during normal boot up and join procedure.
- Once the Tablet receives the first status downlink from the BNA the System LED turns off and the bottom RGB LED reflects the status of the room.

6 Firmware Upgrade Feature

6.1 Overview

The Meeting Room Display Tablet has a bootloader in the flash allow for firmware updates in the field. See the steps outlined below to update the firmware of your device.

6.2 Setup/Requirements

In order to complete a Firmware Upgrade on the Tablet you require the following setup:

- Windows 10 Laptop/PC Required. Drivers for DS may be required to install on the Laptop.
- Teraterm
- Micro USB Cable (see Figure 6-1)
- Meeting Room Display Tablet (see Figure 6-2)

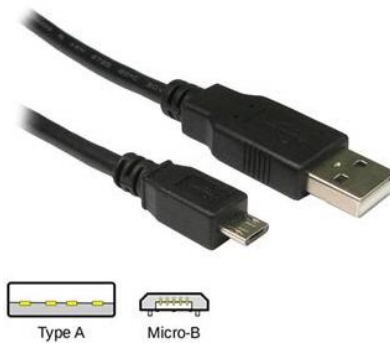

Figure 6-1 USB A to Micro-B Cable

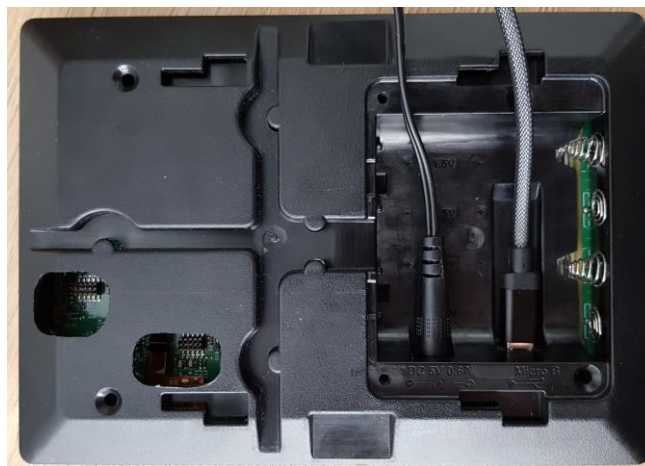

Figure 6-2 Digital Signage Board with power plug and USB cable connected

6.3 Steps to Complete Firmware Upgrade

1. Power Up the Digital Signage.
2. Connect the USB cable to Digital Signage then to Laptop/PC.
3. Then launch the TeraTerm application, then select the serial and select the correct COM Port and select “OK”. (see Figure 6-3)

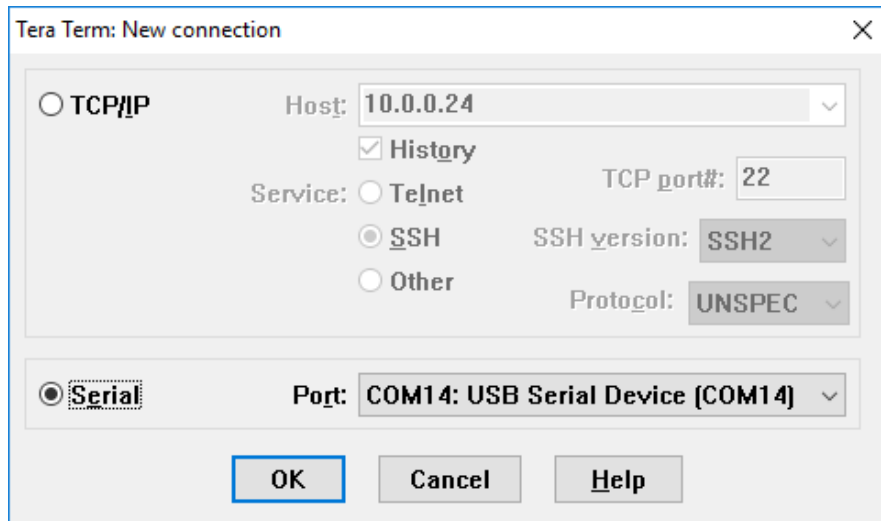

Figure 6-3 Com Power Selection

4. Then click “Setup” menu and then click “Serial Port” then set the “Speed” to 115200. Then click “OK”.

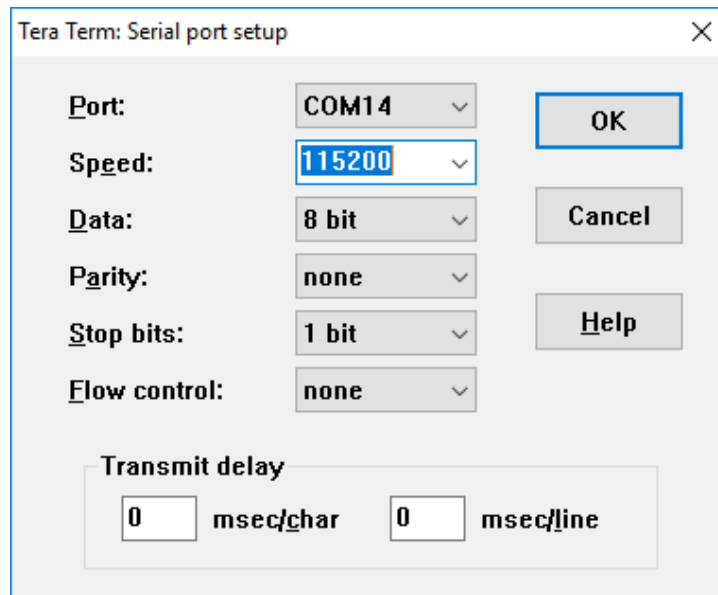

Figure 6-4 Serial Port and Speed Selection

- Then “reset” the Digital Signage by pressing the reset button using pin. Then Teraterm serial console would display “Ready for the firmware file” message along with continuous “C”.

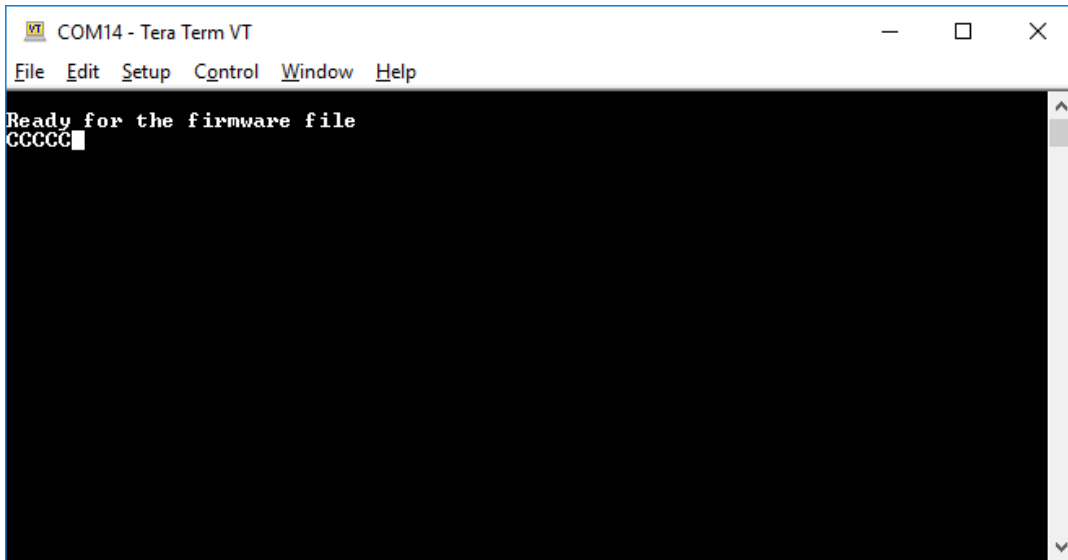

Figure 6-5 Ready for Firmware Note

- Then go to “File->Transfer->XModem->Send”. Then browse and select the FW file (.hex file). Then select “Open”. Then Firmware Upgrade would start. The progress bar would be displayed.

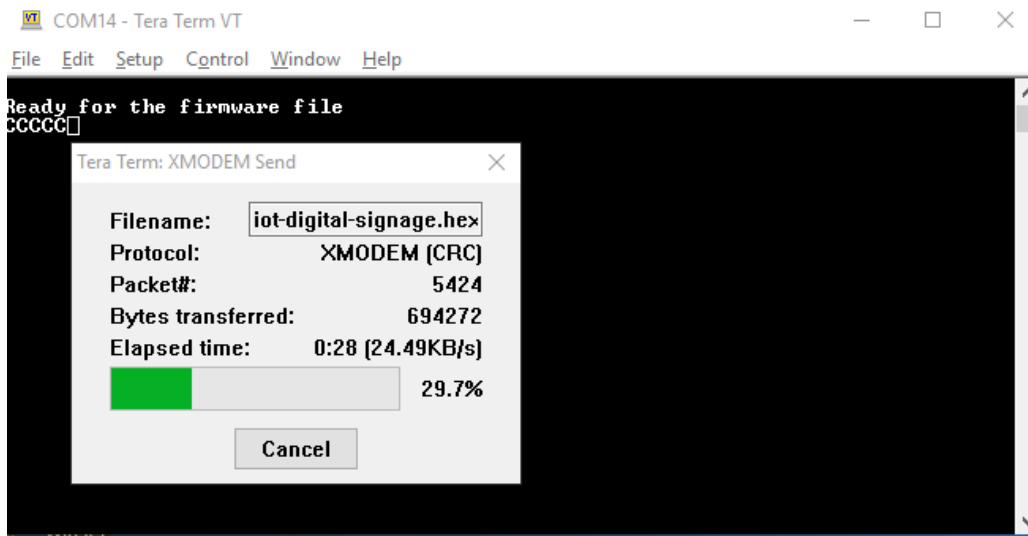

Figure 6-6 Progress Bar

Note: Starting the FW Upgrade should happen within a minute. Otherwise the USB operation would timeout and go to the actual image. These messages would be displayed when it is timed out.

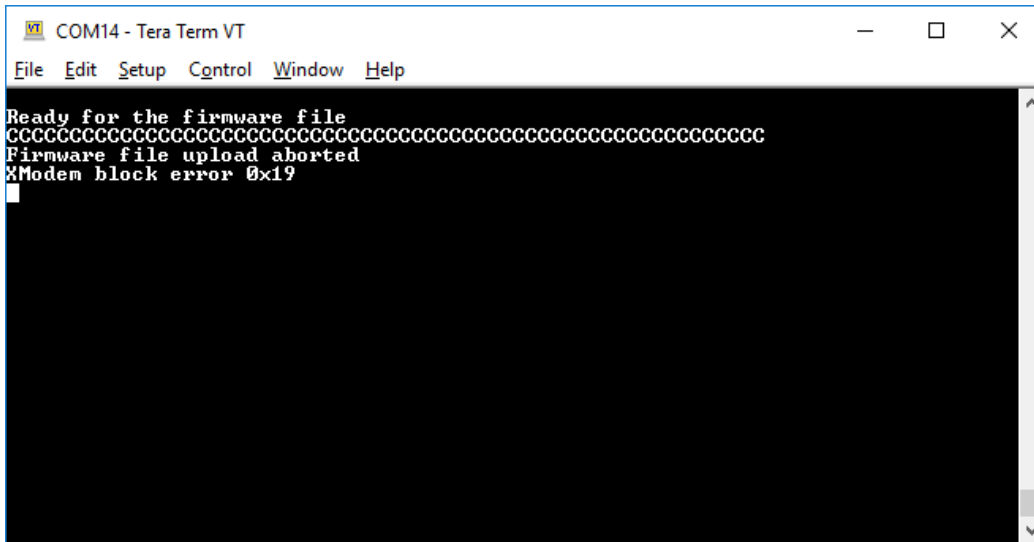

Figure 6-7 Firmware file upload aborted

7. After the successful Firmware Upgrade, the following message would be displayed in the serial console.

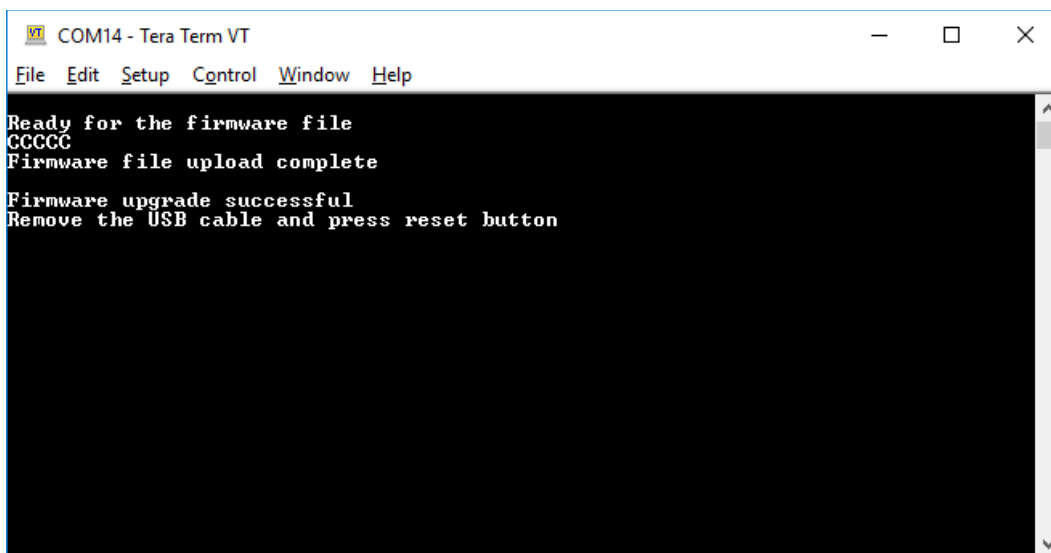

Figure 6-8 Firmware upgrade successful

8. Then as per the messages displayed in serial console, remove the USB cable and press "reset" button on the DS and let the device power up.

7 Compliance Statements

Federal Communications Commission:

This device complies with Part 15 of the FCC Rules. Operation is subject to the following two conditions:

1. This device may not cause harmful interference, and
2. This device must accept any interference received, including interference that may cause undesired operation.

To comply with FCC exposure limits for general population / uncontrolled exposure, this device should be installed at a distance of 20 cm from all persons and must not be co-located or operating in conjunction with any other transmitter.

Changes or modifications not expressly approved by the party responsible for compliance could void the user's authority to operate the equipment. This equipment has been tested and found to comply with the limits for a Class B digital device, pursuant to Part 15 of the FCC Rules. These limits are designed to provide reasonable protection against harmful interference in a residential installation. This equipment generates uses and can radiate radio frequency energy and, if not installed and used in accordance with the instructions, may cause harmful interference to radio communications. However, there is no guarantee that interference will not occur in a particular installation. If this equipment does cause harmful interference to radio or television reception, which can be determined by turning the equipment off and on, the user is encouraged to try to correct the interference by one of the following measures:

- Reorient or relocate the receiving antenna.
- Increase the separation between the equipment and receiver.
- Connect the equipment into an outlet on a circuit different from that to which the receiver is connected.
- Consult the dealer or an experienced radio/TV technician for help.

Innovation, Science and Economic Development Canada:

This device contains licence-exempt transmitter(s)/receiver(s) that comply with Innovation, Science and Economic Development Canada's licence-exempt RSS(s). Operation is subject to the following two conditions:

- (1) This device may not cause interference.

- (2) This device must accept any interference, including interference that may cause undesired operation of the device.

This device should be installed and operated with minimum distance 0.2 m from human body.

L'émetteur/récepteur exempt de licence contenu dans le présent appareil est conforme aux CNR d'Innovation, Sciences et Développement économique Canada applicables aux appareils radio exempts de licence. L'exploitation est autorisée aux deux conditions suivantes:

- a. L'appareil ne doit pas produire de brouillage.
- b. L'appareil doit accepter tout brouillage radioélectrique subi, même si le brouillage est susceptible d'en compromettre le fonctionnement.

Cet appareil doit être installé et utilisé à une distance minimale de 0.2 m du corps humain.

California Proposition 65:

 **WARNING:** This product can expose you to chemicals including lead, nickel & carbon black, which are known to the State of California to cause cancer, birth defects or other reproductive harm. For more information, go to www.p65warnings.ca.gov.

8 Bibliography

- [1] "Meeting Room Booking Application User Guide," 2019.
- [2] "Meeting Room Display Tablet Technical Reference Manual," 2019.
- [3] LoRa Alliance, "LoRaWAN 1.1 Regional Parameters," ver. 1.1, rev. B, Jan 2018.
- [4] "Tektelic Network Server User Guide," 2019.
- [5] LoRa Alliance, "LoRaWAN 1.02 Regional Parameters," Revision B, Feb 2017.
- [6] TEKTELIC Communications Inc., "LoRa IoT Smart Room Sensor Technical Reference Manual (TRM)," ver. 1.0.
- [7] LoRa Alliance, "LoRaWAN Specification," ver. 1.0.2, rev. B, Jul 2016.