



REFERENCE MANUAL



HELLO,

I AM

BOB ASSISTANT!

Your personal assistant
for maintenance

Contact: bob@eolane.com

Table of contents

- I. Introduction4
 - 1.1. Overview4
 - 1.2. Recommended fastening solutions5
 - 1.2.1. Magnets – default configuration5
 - 1.2.2. Rivet6
 - 1.2.3. Screw6
 - 1.2.4. Fixation plate7
 - 1.3. Key Features8
- II. Functional overview9
 - 2.1. Life cycle and Operating modes9
 - 2.1.1. Functional preview9
 - 2.1.2. Startup & initialization9
 - 2.1.3. Operating modes9
 - 2.2. Device Interaction 14
 - 2.2.1. Device Startup 14
 - 2.3. Device power off 16
 - 2.4. BoB ASSISTANT v1.0 ('MPU') and BoB ASSISTANT v1.1 ('KX') Product Variants 17
 - 2.5. Product variants payload identification 18
 - 2.6. Payload data content 18
 - 2.7. Manufacturing configuration 19
 - 2.7.1. Device default configuration 19
 - 2.7.2. Labels 19
- III. Uplink payloads (Device to LoRa server) 21
 - 3.1. Introduction 21
 - 3.2. LEARNING MESSAGE 21
 - 3.2.1. Payload structure 21
 - 3.3. REPORT MESSAGE 22
 - 3.3.1. Payload structure 22
 - 3.3.2. Report message payload data extraction example 24
 - 3.4. ALARM MESSAGE 25
 - 3.4.1. Payload structure 25
 - 3.5. STATE MESSAGE payload structure 26
- IV. Downlink (LoRa to device) 27
 - 4.1. Renew learning mode or add learning 27
 - 4.2. Change sampling period 27
 - 4.3. Enable/disable STATE MESSAGE 27
 - 4.4. Change ALARM MESSAGE threshold 28
- V. Charts examples 29
 - 5.1. Breakdown of the operating time of the machine 29
 - 5.2. Anomaly distribution 29
 - 5.3. Average unnatural vibration level in reports 30
 - 5.4. Number of drift notifications 30

- 5.5. Temperature 30
- 5.6. Maximum vibration value 31
- 5.7. Peak Frequency 31
- 5.8. Report view 32
- 5.9. Vibration drift Alarm view 33
- VI. Payload examples 34
 - 6.1. Raw payload 34
 - 6.1.1. Payload samples for MPU version (BoB v1.0 / PN:3.x) 34
 - 6.1.2. Payload samples for KX version (BoB v1.1 / PN:4.x) 35
 - 6.2. KX version Decode examples 36
 - 6.2.1. LEARNING TYPE 36
 - 6.2.2. REPORT TYPE 37
 - 6.2.3. ALARM TYPE 38
 - 6.2.4. STATE TYPE 39
- VII. Frequently Asked questions 40
 - 7.1. Why monitor vibrations and their drift? 40
 - 7.2. What are the main causes of vibration anomaly? 40
 - 7.3. Which type of equipment is well suited for BoB ASSISTANT? 41
 - 7.4. What is the temperature limit? 41
 - 7.5. When should BoB ASSISTANT be installed on the equipment? 41
 - 7.6. Can we start BoB ASSISTANT on a machine that is not running? 41
 - 7.7. Can BoB ASSISTANT or the machine be moved without disrupting its operation? 42
 - 7.8. What is the autonomy of BoB ASSISTANT sensors? 42
 - 7.9. How to evaluate LorA coverage? What is the operating limit? 42
 - 7.10. First learning and complete learning, what is the difference? 42
 - 7.11. Bob started his learning but does not complete it. Why? 43
 - 7.12. Why one BoB ASSISTANT is taking more time to complete its learning than another one? 43
 - 7.13. Why is BoB ASSISTANT learning several time in the first week of operation? 43
 - 7.14. How to make an additional learning or start BoB ASSISTANT over? 43
 - 7.15. Some data are missing? 43
 - 7.16. Missing data and operating time 43
 - 7.17. BoB ASSISTANT did not detect any anomalies, however, a failure occurred. What to do about it? 44
 - 7.18. What is the difference between alarm and notification? 44
 - 7.19. How to configure a notification trigger threshold? 44
 - 7.20. Why does the learning progress report indicate a value outside of expected values (20%, 40%...)? 44
 - 7.21. Is it possible to check the activity and proper functioning of BoB ASSISTANT on request? 45
 - 7.22. What is the range of BoB ASSISTANT (communication distance) in an industrial environment? 45
 - 7.23. Are the transmitted data secure? 45
 - 7.24. I started BoB ASSISTANT, but no message arrives on the livestream 45
 - 7.25. How do I position BoB ASSISTANT on my machine? 45
- VIII. Document history 46

I. Introduction

I.1. Overview

BoB Assistant is a low power LoRaWAN™ compatible vibration sensor for indoor and outdoor predictive maintenance industrial applications, coupled with a temperature sensor for environmental conditions, a push button and an RGB Led for User Interface.



BoB ASSISTANT will **measure and analyze** vibrations to detect abnormal behaviors of your industrial machines, with artificial intelligence capable of detecting operating anomalies before a failure occurs.

BoB ASSISTANT's casing is IP68 (dust and water proof). Edge AI makes it possible to process locally any vibration that comes from your machine. The amount of data transmitted is then optimized and secured, guaranteeing BoB ASSISTANT's autonomy for several years!

Very easy to install, **BoB ASSISTANT does not require any configuration**. Simply put BoB ASSISTANT on your machine, start it, and after a just few hours of learning, BoB ASSISTANT takes care of your machine!

1.2. Recommended fastening solutions

1.2.1. Magnets – default configuration

BoB ASSISTANT is delivered with a magnet kit, so you can put your device on your machine out of the box.

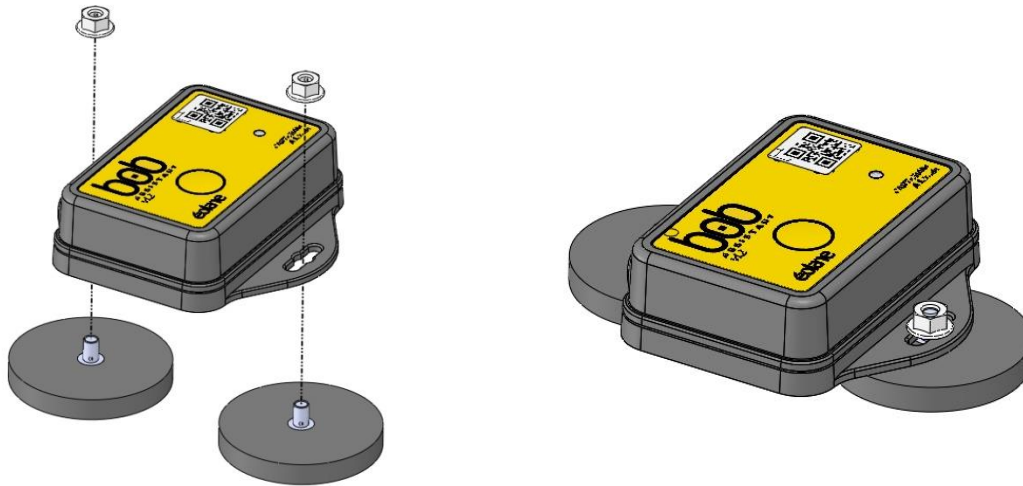

Default configuration:

- Magnet (x2):
 - o Manufacturer: BRUGGER MAGNET
 - o Reference: A22AG-KsM4x6
- Nut (x2):
 - o Manufacturer: BOSSARD
 - o Reference: BN11207 / 3061765

Validated references:

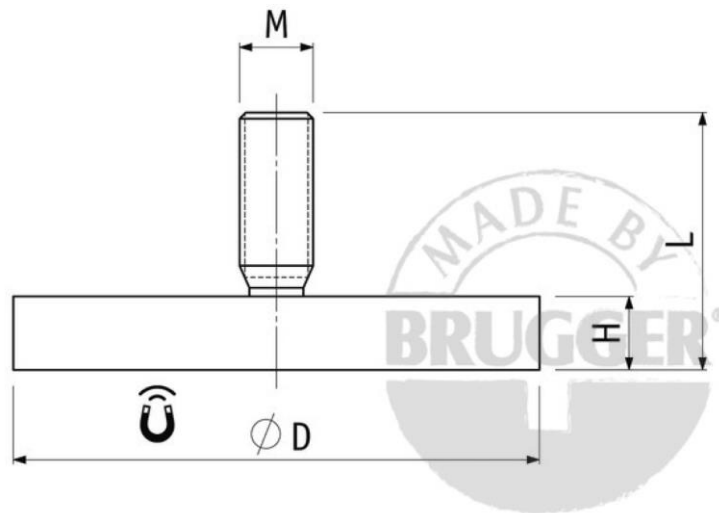

Manufacturer	Reference	Pull Force (kg)	Size (DxHxL / M)	Comments
BRUGGER	A43AG-KsM4x6	10	43x6x12mm / M4x6	Rubber coated magnet (outdoor use, max 60°C)
BRUGGER	A22AG-KsM4x6	6	22x6x12.5mm / M4x6.5	Rubber coated magnet (outdoor use, max 60°C)
ECLIPSE	E1053/NEO	14	20x6x15.5mm/ M4x9.5	Neodymium magnet (indoor use, max 80°C)
ECLIPSE	E1054/NEO	20	25x7x16.5mm / M5x9.5	Neodymium magnet (indoor use max 80°C)

These magnets references have been successfully tested as compliant with ETSI 300-019 class 5.2 when mounted on BoB ASSISTANT.

Class 5.2: all types of road vehicles used in areas with a well-developed road system, except tracked vehicles, motorcycles, scooters and other vehicles with low mass. The equipment can be mounted on surfaces which may be subjected to flying stones. The equipment may be mounted on passenger car instrument panels to which high frequency vibrations from the engine, or from other parts connected to the engine, may be transmitted. This class also applies to fork lift trucks and trains with soft suspension and shock reducing buffers

1.2.2. Rivet

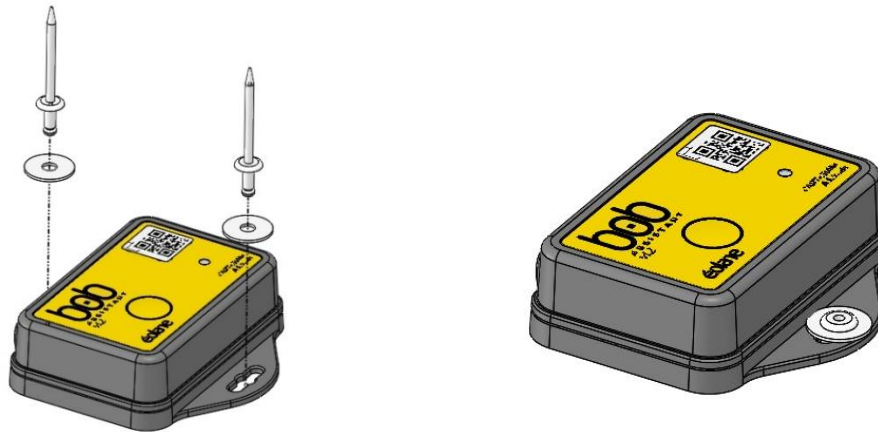

Rivet properties: \varnothing 4mm, length 7/10.2/13.3mm
 Drilling: \varnothing 4.1mm / \varnothing 4.2mm

Manufacturer	Reference	Comments
BOSSARD	BN 84545 / 8031215	Ring washer
BOSSARD	BN 1409 / 3206579	Rivet

1.2.3. Screw

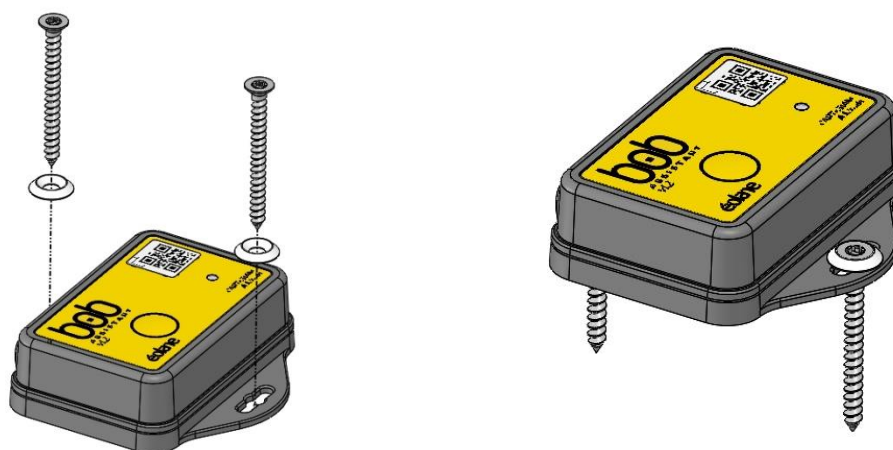

Manufacturer	Reference	Comments
BENE INOX	211309	TF TORX 4x45mm wood screw
WURTH	0455000304	Cup washer

1.2.4. Fixation plate

In order to fasten BoB ASSISTANT on a circular surface, a fixation plate has been designed. It can be fastened using hose clamps:

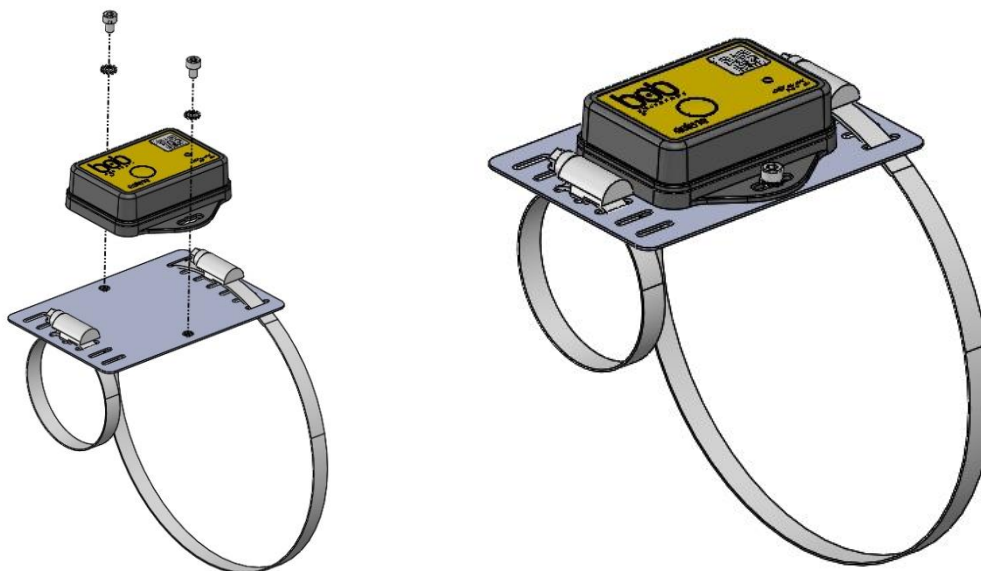

Default configuration:

- Fixation plate (x1):
 - o Manufacturer: EOLANE
 - o Reference: EOM1000200
- Hex socket head cap screw M4x6 (x2)
 - o Manufacturer: BOSSARD
 - o Reference: BN 612 - 1208152
- Serrated lock washer M4 (x2):
 - o Manufacturer: BOSSARD
 - o Reference: BN 4880 - 1184040

Hose clamps references:

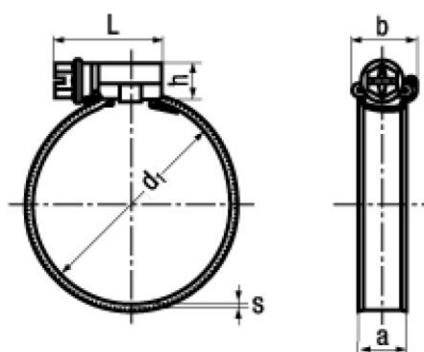

max value for width (a) = 15mm

Manufacturer	Reference (family)	Width (mm)	Comments
BOSSARD	BN 20568 - DIN 3017	9	European store
BOSSARD	BN 20569 - DIN 3017	12	European store
BOSSARD	BN 949 - DIN 3017	9	European / US store
BOSSARD	BN 950 - DIN 3017	12	European / US store

1.3. Key Features

Radio:

Maximum transmission power 25mW in the band
868.0 to 868.6MHz
LoRa SF6-SF12
LoRa 1.0 Class A
LoRa Sensitivity: -137 dBm

Temperature range:

Storage: -25°C to +55°C
Use: -20°C to +55°C

RGB LED:

Network availability,
Learning stage,
And anomaly detection.

Sensor:

3-Axis Accelerometer
Temperature measurement
Vibrations measurement 0Hz-500 Hz (MPU version)
Vibrations measurement 0Hz-11800 Hz (KX version)
Adjustable periodic sampling

Firmware:

Automatic learning process and reporting by
embedded artificial intelligence.
Possibility to add new learning or to reset learning.
AES-128 Encrypted data

Power supply:

Battery, 2 years warranty (normal use)

Case:

Polyamide case
Dimensions: 76 x 79 x 23 mm
Weight: 75 grams
IP68 Protection

Tests and Certifications:

CE marking, qualified for industrial use in
accordance with
EN 61000-6-2.
ETSI EN 300 019:
Storage Class 1.2 Part 1.1
Transport Class 2.3 Part 1.2
Use Class 5.2 Part 1.5



II. Functional overview

2.1. Life cycle and Operating modes

2.1.1. Functional preview

The following figure presents the different modes of operation of the device:

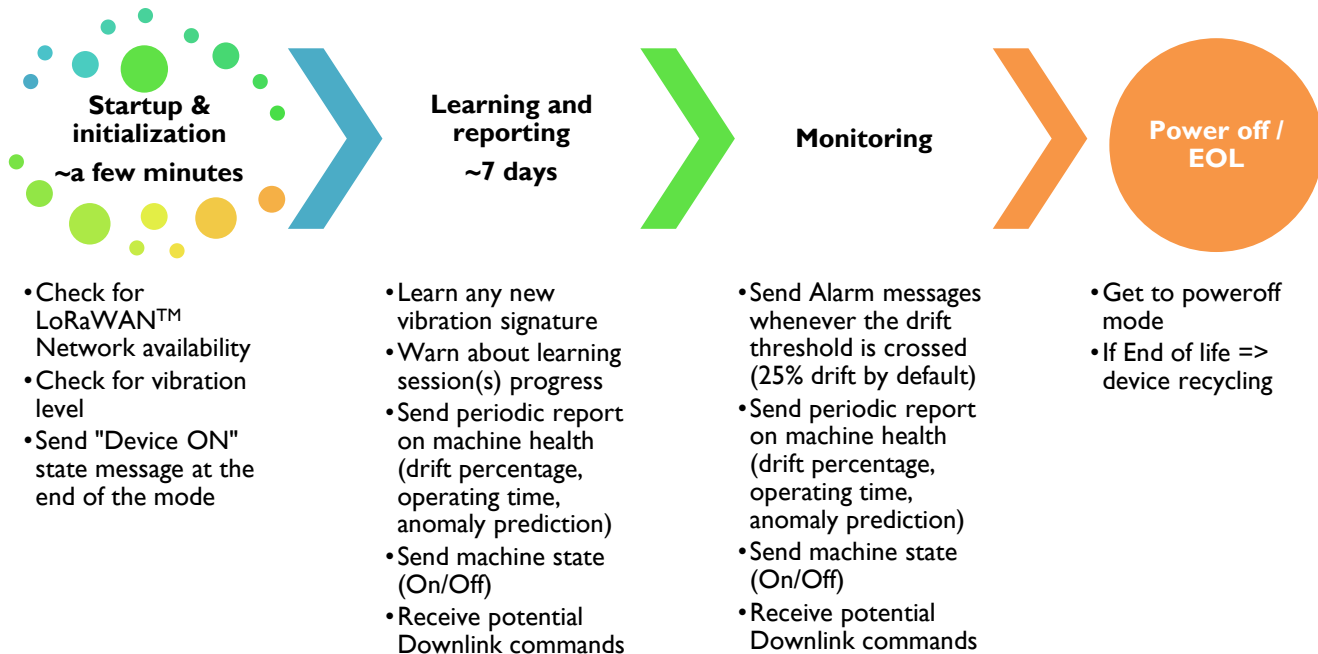

2.1.2. Startup & initialization

The first step when you install BoB ASSISTANT on a machine you want to monitor will be to start the device, and make sure that:

- the LoRaWAN™ Network is reachable
- the vibration level of the machine is high enough

See §2.2.1 Device Startup for more details.

When the Startup & initialization mode is over, BoB ASSISTANT will then have 2 operating modes :

- Learning and Reporting
- Monitoring

2.1.3. Operating modes

2.1.3.1. Learning and reporting

This mode will last for ~7days, and will allow BoB ASSISTANT to learn the machine cycle(s). BoB ASSISTANT will start by a first learning session, and will then start reporting. Each time a new vibration signature is detected, BoB will start another learning session, in parallel with the reporting mode.

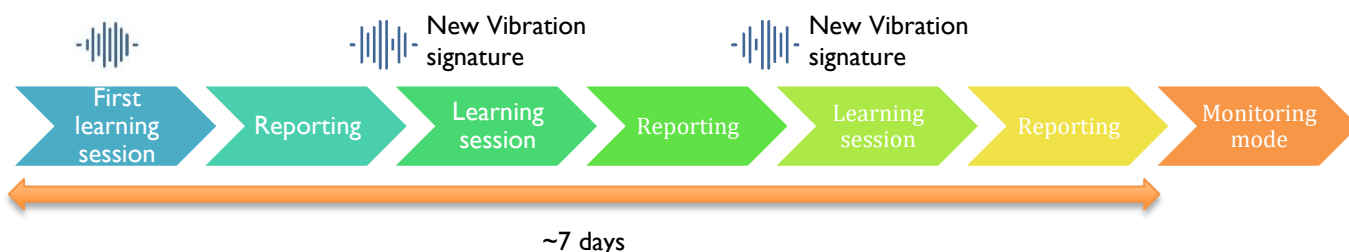

2.1.3.1.1. First learning session

Once BoB ASSISTANT is started, it will enter a first Learning session, which will last for a few hours (~1 to 4 hours for a machine with a simple vibration cycle, e.g. Air Conditioning unit).

This learning session will create a first dataset for the embedded AI algorithms and store the “screenshots” of the corresponding vibration signatures.

For each measure, it will perform a Fast Fourier Transform (FFT):

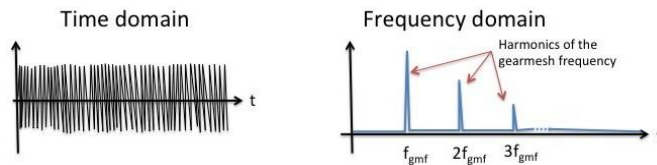

It will then add each new signal information to the vibration signature dataset.

For example, after a few hours of operation, the dataset could have more than 30 “screenshots” for the vibration signature of the machine:

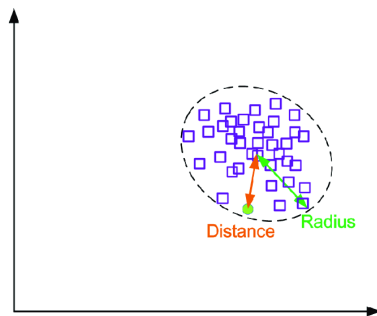

In the first seven days of operation, BoB ASSISTANT will continue monitoring new vibration signatures, and add them to the dataset.

After this period of time, no new vibration signature will be added to the dataset, unless it is required through a Downlink command (see §IV Downlink (LoRa to device)).

During a learning session, BoB ASSISTANT will wake up every 60 seconds (default value, configurable, see §4.2 Change sampling period) to sample the signal, perform the FFT of the vibration signature and compare and record the sampling to the dataset. BoB ASSISTANT’s dataset is able to record up to 20 different vibration signature zones.

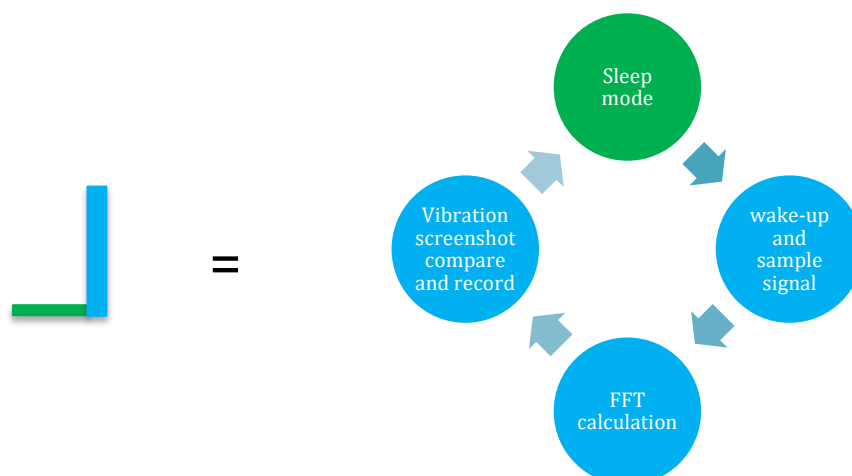
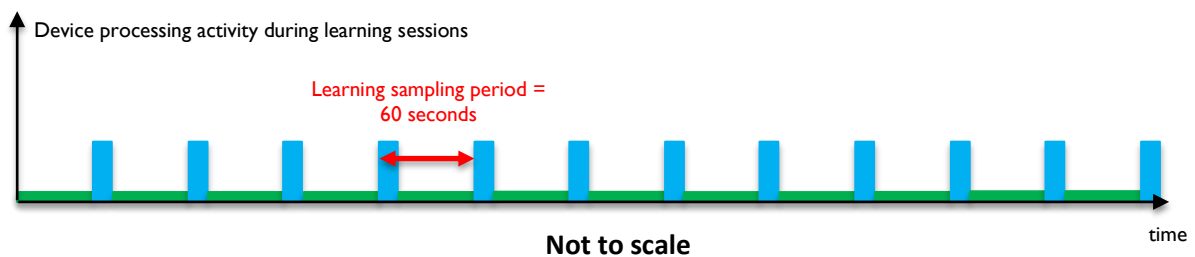

Please be advised:

- if the vibration level was high enough at startup, but then is going below the minimum level of detection in the first 7 days, the device might get stuck in a Learning session. In this case, we advise to change BoB location on the machine to put it as close as possible to the vibration source, or on a less vibration-insulated element.
- If a new machine cycle appears after the first seven days (e.g. production rate increase), it might be considered by BoB ASSISTANT as an anomaly. In this case, you will have to send a Downlink command to BoB ASSISTANT in order to add this cycle to the dataset.

During the Learning session, the device will send messages to keep you posted on the learning percentage (0 to 100%), for example:

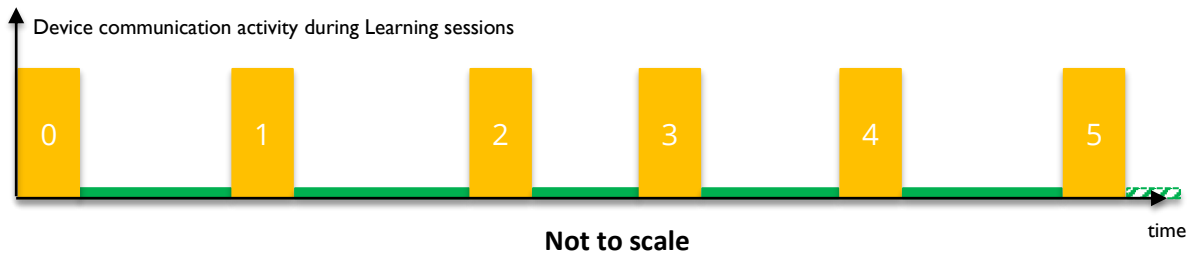

Each message will send details on the progress percentage of the learning session (most of the time 5 messages from 0 to 100, with a 20% step), environmental information (temperature, vibration level, peak frequency), and a screenshot of the FFT (see §3.2.1 Payload structure)

2.1.3.1.2. Reporting

After the first Learning session, BoB ASSISTANT will switch to the reporting mode, where it will analyze the machine vibration every 5 minutes:

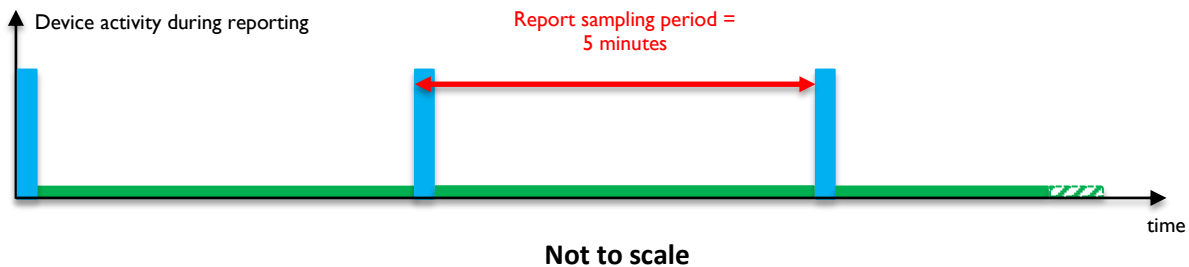

BoB ASSISTANT will process each sample to define whether a new learning session is needed, or to prepare a report of the activity sent in periodic reports (every 3 hours, not configurable) concerning the health of the machine during this period, regarding:

- the operation time of the machine,
- its vibration level,
- the vibration drift percentage,
- and prediction on potential failure distance in time, based on the vibration analysis of the last 24 hours, the last 30 days, and the last 6 months

See §3.3.1 Payload structure for more details on report messages content.

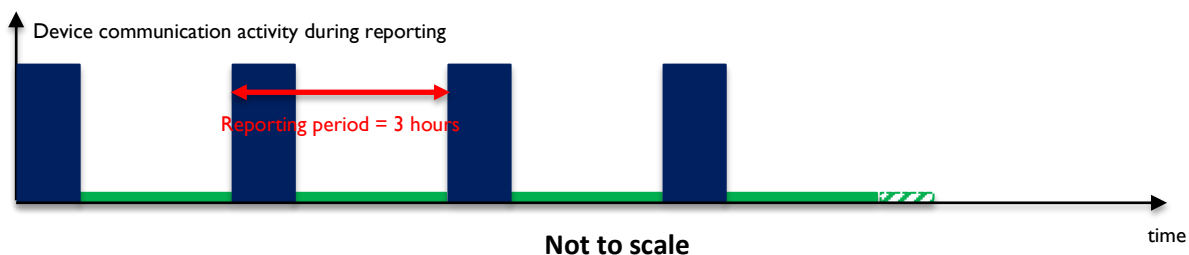

2.1.3.1.3. End of learning mode

At the end of the learning mode (~7 days), BoB ASSISTANT will have completed its dataset.

For example, BoB ASSISTANT could have the following dataset, with two distinct vibration cycles with their respective standard deviation from average point (radius)

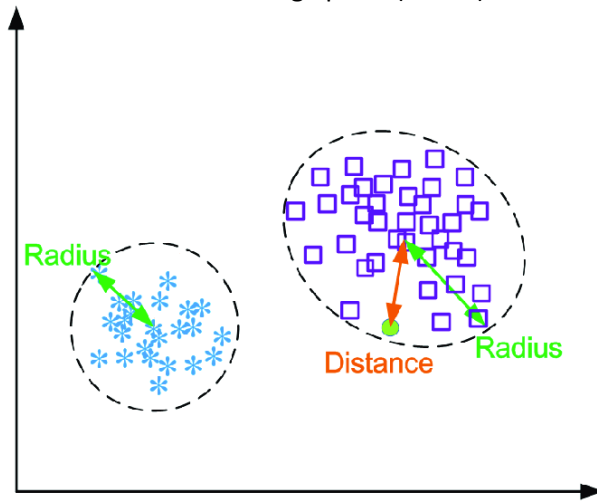

2.1.3.2. Monitoring

After the learning mode, BoB ASSISTANT will switch to Monitoring mode, where it will continue its reporting activity, and will start sending alarms if the drift in the vibration signature pass a defined threshold (default value is 25% drift).

For each signal sampling (every 5 minutes by default), BoB ASSISTANT will process the sampled signal, and compare it to its dataset:

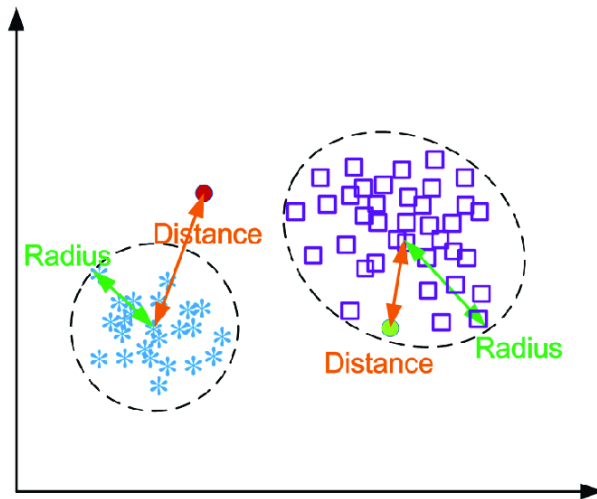

For the green sample, the distance/drift of the point compared with the average point is within the defined threshold (default drift percentage threshold is 25%). In this case, BoB will add the recorded data to prepare the periodic report

For the red sample, the distance/drift of the point compared with the average point is beyond the defined threshold. In this case, BoB will send an ALARM MESSAGE. The drift percentage triggering an ALARM MESSAGE can be customized, see §4.4 *Change ALARM MESSAGE threshold*.

The alarm message can then trigger an e-mail/SMS alert at the platform level (cloud or on premise), which will be sent to maintenance teams for machine inspection.

2.1.3.3. Configurable parameters

Some parameters of BoB ASSISTANT can be tuned to adapt to the equipment operation. For more information on how to change the parameters see §IV Downlink (LoRa to device)

2.1.3.3.1. Sampling period

BoB ASSISTANT will periodically wake up to sample the vibration signal of the machine (sampling duration = 0.25s). By default, it will wake up every 60 seconds during the learning and reporting mode (first 7 days), and will then wake up every 5 minutes during the monitoring mode.

Some machines could need to have some different settings, e.g. machines with short operating cycles.

Mode	Learning period	Monitoring Period
Very Fast	10 sec	20 sec
Fast	20 sec	2 min
Default	60 sec	5 min
Slow	2 min	10 min

Please be advised: setting BoB ASSISTANT in Fast or Very Fast mode will have consequences on the device lifespan.

2.1.3.3.2. State messages

BoB ASSISTANT will send machine status when it detects that the machine is turning ON or OFF, based on sample results. These messages are enabled by default, they can also be disabled.

State message parameters
Enable State Message (default)
Disable State Message

Please be advised: for machines with very short cycles, it is recommended to disable the state messages, as it could have dramatic effect on the device lifespan.

2.2. Device Interaction

2.2.1. Device Startup

2.2.1.1. Turning BoB ASSISTANT ON

BoB ASSISTANT is OFF by default when delivered.
In order to start BoB ASSISTANT, you need to:

- Place BoB ASSISTANT on the machine you want to monitor(see §1.2 *Recommended fastening solutions*)
- Turn the device ON by pushing on the button for more than 2 seconds, the LED will then blink twice in green ●●

You can then release the button, the device is ON

2.2.1.2. Startup and trouble shooting

2.2.1.2.1. Startup

Once switched ON, BoB ASSISTANT starts its initialization mode.

It then tries to reach the LoRaWAN™ Network using OTAA (Over The Air Activation) and ensures that the perceived vibration level is sufficient (>0.01g). During this mode, the LED is continuously blue (●).

The initialization mode lasts for around 1 minute and 35 seconds (depending on LoRaWAN™ Network coverage)

At the end of this initialization mode, if the device has reached the LoRaWAN™ Network, and the perceived vibration level of the machine is sufficient (>0,01g), then the device will blink 5 times in green ●●●●●, the LED will stay OFF and BoB ASSISTANT is ready to start its duty and enter the Learning mode (see §2.1.3.1 *Learning*)

BoB ASSISTANT will then send a state message to warn that the device has started and everything is OK (see §3.5 *STATE MESSAGE payload structure*)



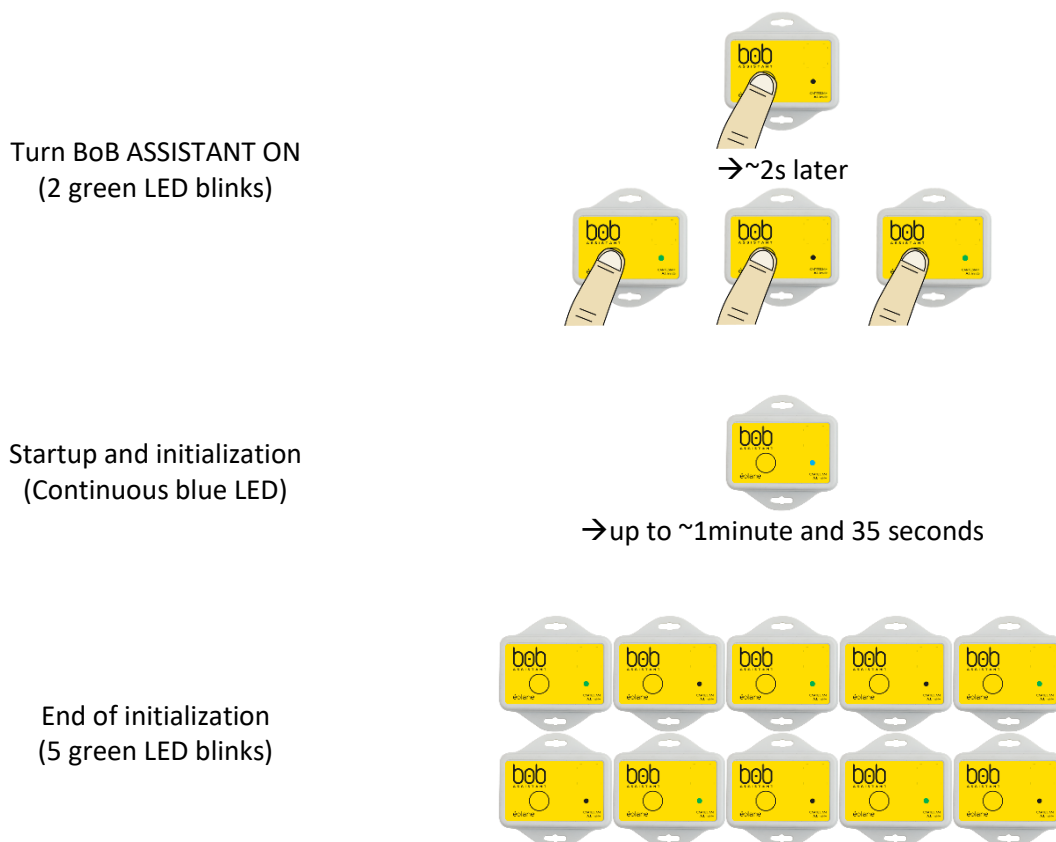

The following figure displays the different steps of the startup

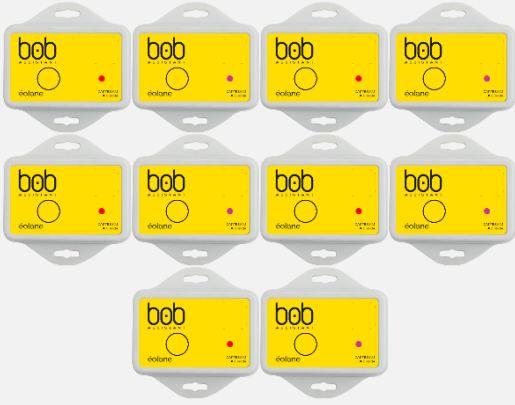

2.2.1.2.2. Troubleshooting

Please be advised: If the LoRaWAN™ Network was unreachable or if the vibration level is below the minimum level, the device will not start its duty, but will go back to deep sleep mode. To restart the device, follow §2.2.1.1 Turning BoB ASSISTANT ON

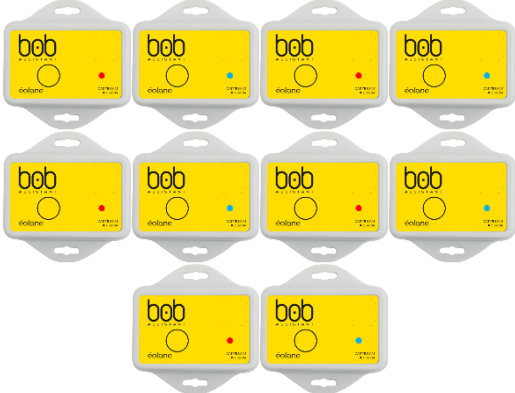
The following table summarizes the different sequences displayed by the LED, depending on the origin of the problem:

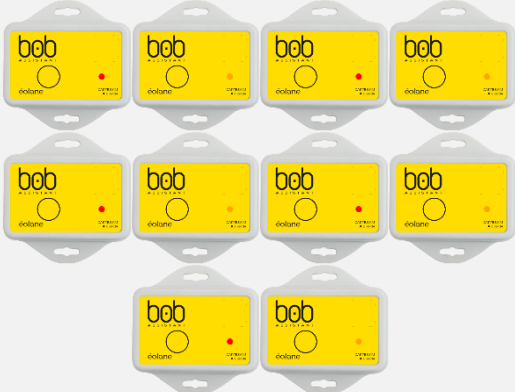
Origin of the problem	Corresponding LED sequence on BoB ASSISTANT	Problem solving
<p>LoRaWAN™ Network unreachable</p> 	<p>5x ●●</p> 	<p>- Check device declaration on the LoRaWAN™ Network Server (NS), make sure that DEV_EUI, APP_EUI and APP_Key are all correctly declared on the NS. If you did not receive the keys for your device, please contact us.</p> <p>- Check Network coverage on the BoB ASSISTANT installation location. If BoB ASSISTANT is out of range, you can either add a gateway if you run your own network, or contact your operator to check for solutions</p>
<p>Vibration level below the minimum level</p> 	<p>5x ●●</p> 	<p>Change BoB ASSISTANT location on the machine, and try to put it as close as possible to the vibration source, or on a less vibration-insulated element. BoB ASSISTANT perceives vibrations of very low amplitude (minimum 0.01g), there is surely a suitable place!</p>
<p>Hardware problem</p> 	<p>5x ●●</p> 	<p>In this case, BoB ASSISTANT must be replaced and we invite you to contact our support team</p>

2.3. Device power off

In case you need to move BoB ASSISTANT from a machine to another and reset the vibration learning, it is possible to turn BoB ASSISTANT off.

To do so, push the button for ~10/12s, until you see the green/yellow/red sequence on the LED. Once the LED is red, you can release the button, the device is off.

Turn BoB ASSISTANT OFF
(green->orange->red)

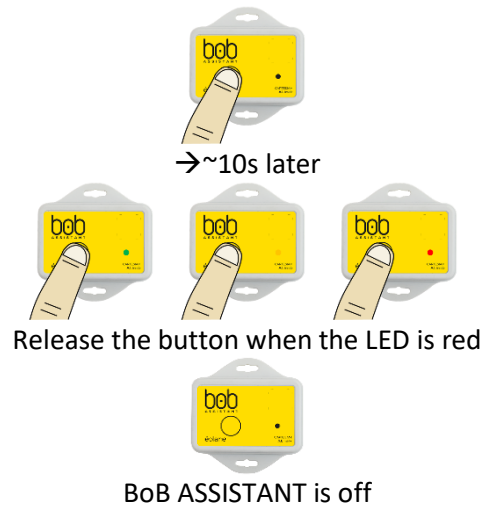

To turn BoB Assistant back on, follow the steps described in §2.2.1.1 Turning BoB ASSISTANT ON

2.4. BoB ASSISTANT v1.0 ('MPU') and BoB ASSISTANT v1.1 ('KX') Product Variants

BoB ASSISTANT is available in 2 major variants, depending on the accelerometer sensor reference. Those 2 variants both present different range of measurement, accuracy, and therefore monitoring capabilities.

Version	Sensor type	P/N*	Monitored frequencies	Sampling rate	Peak Frequency value	32 values FFT report	Regions
BoB v1.0	MPU	3.x	0 - 500 Hz	1000 Hz	0- 500 Hz	32 values between 0 and 500Hz (step=15,625 Hz)	EU only
BoB v1.1	KX	4.x	0 - 12800 Hz	Low Frequency 800Hz and High Frequency 25600Hz	0 - 400 Hz	32 values between 0 and 3200 Hz (step=100Hz)	EU US (prototype)

*Refer to the rear label of the product

MPU

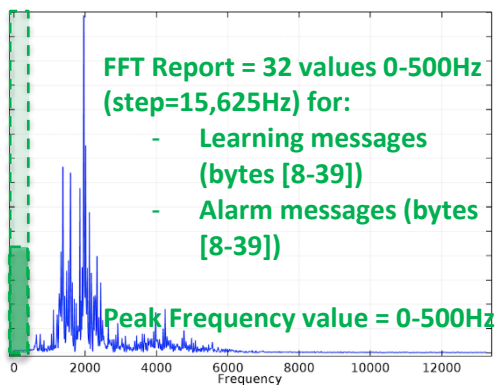
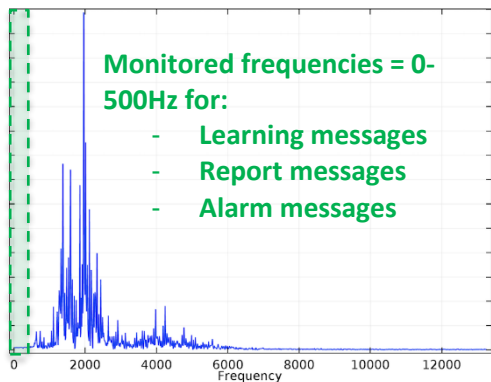

KX

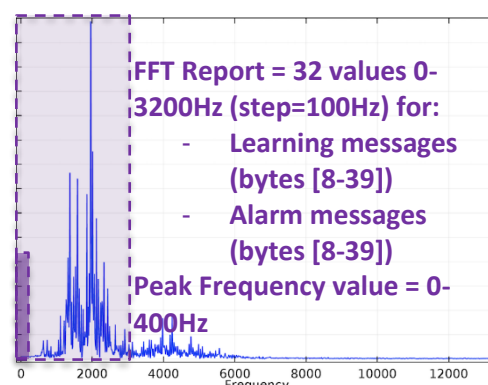
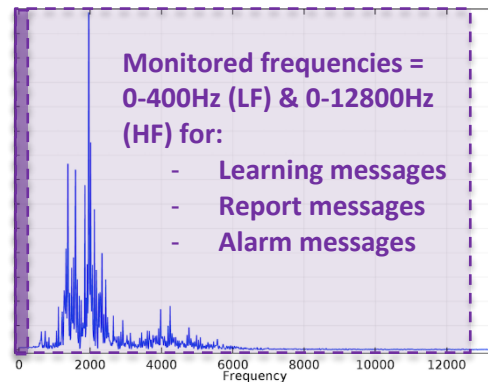

FFT calculation is done on the 0-12800Hz window (on 128 steps of 100Hz each), but FFT report only includes the 0-3200Hz window values

2.5. Product variants payload identification

Each type of message is identified using the byte 0 of the payload (except for state message, which has the same ID for MPU and KX versions (decimal = 83 / hex=0x53)).

ID Value is different between KX and MPU in order to know if the message is coming from a MPU or KX device.

Example: for the 'report message' frame, a MPU payload is identified by the byte 0 = 'r' (ASCII value for 'r': decimal = 82 / hex=0x52), as for KX sensor, the payload is identified by the byte 0 = 'R' (ASCII value for 'R': decimal = 114 / hex=0x72). See §III Uplink payloads (Device to LoRa server) for more details.

2.6. Payload data content

MPU and KX are sending the same message. However, the **peak frequency** value is calculated using the following Low Frequency data rate.

- MPU:
 - `FREQ_SAMPLING_ACC_LF` = `FREQ_SAMPLING_ACC_HF` = 1000 Hz
- KX:
 - The KX version will make 2 samplings, with 2 distinct sampling rates
 - `FREQ_SAMPLING_ACC_LF` = 800Hz
 - `FREQ_SAMPLING_ACC_HF` = 25600Hz

For the KX version, the `FREQ_SAMPLING_ACC_LF` sampling is done to observe potential drift in low frequencies with a relatively high precision, whereas the `FREQ_SAMPLING_ACC_HF` allows the sampling of a large frequency window, with less precision.

For MPU version, the peak frequency is calculated in the [0; 500Hz] window, and for KX version, it is calculated in the [0; 400Hz] window, with an index value in the [0; 127] range. MPU version peak frequency step is 7.81Hz, and for KX version, the step is 6.25Hz.

Note: Due to frame size limitation implied by the LoRaWAN™ protocol, a compromise has been made for the FFT values sent for KX version: 32 values are sent between 0 and 3200Hz, with a 100Hz step. Sending the full frequency window in the FFT values (0 to 12800Hz) would make the step too wide (400Hz) and not relevant.

2.7. Manufacturing configuration

2.7.1. Device default configuration

When delivered, the device will be **OFF**. To switch the device **ON**, please see §2.2.1 Turn the device ON.

The default LoRaWAN™ configuration is OTAA (Over The Air Activation, with DevEUI, and AppEUI contained in the QR code of the product sticker, see QR code). AppKey is transmitted along with DevEUI and AppEUI through Excel sheet via e-mail at the moment.

2.7.2. Labels

2.7.2.1. Front Label

	Label	Label content
Legacy label		32 digits Datamatrix content: AAAAAAAAAAAAAAAAAADDDDDDDDDDDDDDDDD with AAAAAAAAAAAAAAAAAA = Device APP_EUI (first 16 digits) DDDDDDDDDDDDDDDDD = Device DEV_EUI (last 16 digits) e.g. 70B3D531C000002070B3D531C0001140 Cleartext content: "SN:123456789" = Device Serial Number, e.g. "SN:000007241"
Current label		16 digits Datamatrix content: DDDDDDDDDDDDDDDDD with DDDDDDDDDDDDDDDDD = Device DEV_EUI (last 16 digits) e.g. 70B3D531C0002C13 Cleartext content: "70B3D531C0002C13" = Device DEV_EUI "SN:000012990" = Device Serial Number

2.7.2.2. Rear Label

	Label	Label content
Legacy label		<p>45 digits Datamatrix content: AAAAAAAAAAAAAAAAAAADD DDDDDDDDDDDDDDDDDYYMM123456789 with AAAAAAAAAAAAAAAAAA = Device APP_EUI (first 16 digits) DDDDDDDDDDDDDDDDD = Device DEV_EUI (16 digits) YYMM = Device manufacturing year YY (2 digits) and week WW (2 digits) 123456789 = Device Serial Number (last 9 digits) e.g. 70B3D531C000002070B3D531C00011401823000007241</p> <p>Cleartext content: "PN : X.Y" = Device Part Number, e.g. "PN : 3.A" "SN:123456789" = Device Serial Number, e.g. "SN:000007241"</p>
Current label		<p>45 digits Datamatrix content: AAAAAAAAAAAAAAAAAAADD DDDDDDDDDDDDDDDDDYYMM123456789 with AAAAAAAAAAAAAAAAAA = Device APP_EUI (first 16 digits) DDDDDDDDDDDDDDDDD = Device DEV_EUI (16 digits) YYMM = Device manufacturing year YY (2 digits) and week WW (2 digits) 123456789 = Device Serial Number (last 9 digits) e.g. 70B3D531C000002070B3D531C00011401823000007241</p> <p>Cleartext content: "Bob Assistant By Eolane" = Device name "PN : X.Y" = Device Part Number, e.g. "PN : 4.1" "Ref: EOS600011040-EUN" = Device Reference "SN:123456789" = Device Serial Number, e.g. "SN:000007241"</p>

III. Uplink payloads (Device to LoRa server)

3.1. Introduction

BoB ASSISTANT sends 4 types of messages: **LEARNING**, **REPORT**, **ALARM** and **STATE**. The payload for each message has a different structure, and each message type is identified with the byte 0 of the payload (header).

- **LEARNING** occurs only during the Learning mode (up to 7 days);
- **REPORT** is sent each 3 hours (default configuration);
- **ALARM** message is sent when anomaly level reaches XX% (25% default).
- **STATE** is sent when the measured equipment changes its state from ON to OFF or OFF to ON (start/stop), or when sensor is on.

STATE message is the first applicative payload sent by the device after power-on.

3.2. LEARNING MESSAGE

3.2.1. Payload structure

Byte	Definition	Value (dec)	Real_Value (dec)	Unit	Range	Type	Comments
0	Header	MPU = 76 Or KX = 108		const		N/A	Sensor type : MPU = "L" (hex=0x4C) => Learning header or KX = "I" (hex=0x6C) => learning header
1	Learning percentage	0~100	Value	%	[0,100]	integer	0-100: Percentage of the learning process
2	Vibration level (vl_1)	0~127	Value	g	[0,127]	float	Vibration level measured for the last sample of the current learning stage $vl=(vl_1*128+vl_2+vl_3/100)/10/121.45$; the threshold of vibration level is 0.01g
3	Vibration level (vl_2)	0~127	Value				
4	Vibration level (vl_3)	0~127	Value				
5	Peak frequency index	0~127	Value+1	Hz	[0,127]	integer float	Frequency index value with the highest vibration level measured for the last sample of the current learning stage Frequency_index=Value+1; It is possible to retrieve the corresponding peak frequency value based on the Frequency_index value: Frequency_value=(Value+1)*FREQ_SAMPLING_ACC_LF/256
6	Temperature	0~127	Value-30	°C	[-30,97]	integer	Temperature measured during the last sample of the current learning stage The Value is constrained to be with a range [-30,97]
7	Learning type	0~1	Value			boolean	Learning from 0 or additional learning : 1: Learning from 0; 0: Additional learning
8~39	FFT signal	0~127		g; Hz		float float float	FFT signal measured for the last sample of the current learning stage Value_g=Value*vl/127; (see bytes 2-3-4 for vl value calculation) MPU (peak frequency step = 7.81Hz): Frequency_hz=4*(i+1)*FREQ_SAMPLING_ACC_HF/256 (i is the index of FFT array, begins from 0, ends by 31) KX (peak frequency step =6.25Hz): Frequency_hz=(i+1)*FREQ_SAMPLING_ACC_HF/256 (i is the index of FFT array, begins from 0, ends by 31)

3.3. REPORT MESSAGE

3.3.1. Payload structure

Byte	Definition	Value (dec)	Real_Value (dec)	Unit	Range	Type	Comments
0	Header	MPU=82 Or KX=114		const		N/A	Sensor type : MPU = "R" (hex=0x52) => Report header or KX = "r" (hex=0x72) => report header
1	Anomaly level (in %)	0~127	Value*100/127	%	[0,100]	integer	Vibration drift percentage between the measured vibration signature and the vibration signature learned by BoB ASSISTANT
2	Operating time	0~127	Value*report_period/127	Minute	[0, report_period]	integer	Operating time of the monitored equipment over the report period (report period=byte 6)
3	[0%-10%] anomaly level time	0~127	Value*operating time/127	Minute	[0, report_period]	integer	Time, in minutes, spent in the [0%-10%] anomaly level range over the report period
4	Alarm Number	0~127	Value		[0,127]	integer	Number of alarms during this report period
5	Temperature	0~127	Value-30	°C	[-30,97]	integer	
6	Report period (R_V)	0~127	Value	Minute		integer	If R_V<=59, report_period = R_V If R_V>59, report_period = (R_V-59)*60
7	Report ID	0~9	Value		[0, 9]	integer	Used to identify the message (increased with each transmission)
8	Vibration level (vl_1)	0~127	Value				
9	Vibration level (vl_2)	0~127	Value	g	[0,127]	float	Max amplitude value (on 3 bytes) vl=(vl_1*128+vl_2+vl_3/100)/10/121.45
10	Vibration level (vl_3)	0~127	Value				
11	Peak frequency index	0~127	Value+1			integer	Frequency index value with the highest vibration level recorded Freq_index=Value+1; It is possible to retrieve the peak frequency value based on the Frequency_index value: Frequency_value=(Value+1)*FREQ_SAMPLING_ACC_LF/256
12	[10%-20%] anomaly level time	0~127	(Operating time - [0%-10%] anomaly level time)*Value/127	Minute	[0, report_period]	integer	Time, in minutes, spent in the [10%-20%] anomaly level range over the report period
13	[20%-40%] anomaly level time	0~127	(Operating time - [0%-10%] anomaly level time)*Value/127	Minute	[0, report_period]	integer	Time, in minutes, spent in the [20%-40%] anomaly level range over the report period
14	[40%-60%] anomaly level time	0~127	(Operating time - [0%-10%] anomaly level time)*Value/127	Minute	[0, report_period]	integer	Time, in minutes, spent in the [40%-60%] anomaly level range over the report period
15	[60%-80%] anomaly level time	0~127	(Operating time - [0%-10%] anomaly level time)*Value/127	Minute	[0, report_period]	integer	Time, in minutes, spent in the [60%-80%] anomaly level range over the report period
16	[80%-100%] anomaly level time	0~127	(Operating time - [0%-10%] anomaly level time)*Value/127	Minute	[0, report_period]	integer	Time, in minutes, spent in the [80%-100%] anomaly level range over the report period
17	Battery percentage	0~127	Value*100/127	%	[0,100]	integer	Remaining battery level
18	24h 20% Anomaly level prediction	0~255	Value	hour	[0,255]	integer	Time, in hour, when anomaly level is expected to reach 20% (Prediction based on the data of last 24 hour) 255=infinite time
19	24h 50% Anomaly level prediction	0~255	Value	hour	[0,255]	integer	Time, in hour, when anomaly level is expected to reach 50% (Prediction based on the data of last 24 hour) 255=infinite time
20	24h 80% Anomaly level prediction	0~255	Value	hour	[0,255]	integer	Time, in hour, when anomaly level is expected to reach 80% (Prediction based on the data of last 24 hour) 255=infinite time

Byte	Definition	Value (dec)	Real_Value (dec)	Unit	Range	Type	Comments
21	30days 20% Anomaly level prediction	0~255	Value	day	[0,255]	integer	Time, in days, when anomaly level is expected to reach 20% (Prediction based on the data of last 30 days) 255=infinite time
22	30days 50% Anomaly level prediction	0~255	Value	day	[0,255]	integer	Time, in days, when anomaly level is expected to reach 50% (Prediction based on the data of last 30 days) 255=infinite time
23	30days 80% Anomaly level prediction	0~255	Value	day	[0,255]	integer	Time, in days, when anomaly level is expected to reach 80% (Prediction based on the data of last 30 days) 255=infinite time
24	6months 20% Anomaly level prediction	0~255	Value	month	[0,255]		Time, in months, when anomaly level is expected to reach 20% (Prediction based on the data of last 6 months) 255=infinite time
25	6months 50% Anomaly level prediction	0~255	Value	month	[0,255]		Time, in months, when anomaly level is expected to reach 50% (Prediction based on the data of last 6 months) 255=infinite time
26	6months 80% Anomaly level prediction	0~255	Value	month	[0,255]		Time, in months, when anomaly level is expected to reach 80% (Prediction based on the data of last 6 months) 255=infinite time

3.3.2. Report message payload data extraction example

Report payload:0x52087f5a00353e090019260c552a00007c77ffffffffffffff

byte	0	1	2	3	4	5	6	7	8	9	10	11	12	13	14	15	16	17	18	-	-	-	-	-	-	-	26
	52	08	7f	5a	00	35	3e	09	00	19	26	0c	55	2a	00	00	00	7c	77	ff	ff	ff	ff	ff	ff	ff	ff

Byte	Definition	hex	dec	Value	Unit	Comments	
0	Header	52	82	Sensor type=82=ASCII "R" =>Report for MPU version	-	Report header ID for MPU version	
1	Anomaly level (in %)	08	8	$8*100/127=6.3$	%	Calculated over « machine on » time	
2	Operating time	7f	127	$127*180/127=180$	min	Report length=180 minutes Operating rate in percentage: [decimal Value]*100/127	
3	[0%-10%] anomaly level time	5a	90	$90*180/127=128$	min	To get the value in percentage: [value in min]/[Report period]*100	
4	Alarm Number	00	0	0	-	No alarms during this report period	
5	Temperature	35	53	$53-30=23$	°C	Hardware offset	
6	Report period (R_V)	3e	62	$62>59$ => Report period = (value - 59) * $60=(62-59)*60=3*60=180$	min	If value < 59 =>= value If value > 59 =>= (value - 59) * 60	
7	Report ID	09	9	9	-	9 th report (next report ID will reset to 0)	
8	Maximum vibration amplitude (3 bytes)	00	0	$vl=(vl_1*128+vl_2+vl_3/100)/10/121.45$	g	$vl=0.0209g$	
9	Vibration level 1 (vl_1)	19	25	$=> vl=(0*128+25+38/100)/10/121.45$ $vl=0.0209$			
	Vibration level 2 (vl_2)						
10	Vibration level 3 (vl_3)	26	38				
11	Peak frequency index (frequency with the highest vibration level recorded)	0c	12	Freq_index=Value+1=13 Freq_value=(Value+1)*FREQ_SAMPLING_ACC_LF/256=13*1000/256=50,78	Hz	Freq_index=13 Freq_value=50,78Hz (reminder: MPU: FREQ_SAMPLING_ACC_LF=1000 KX: FREQ_SAMPLING_ACC_LF=800)	
12	[10%-20%] anomaly level time	55	85	$(180-128)*85/127=35$	min	Raw data of time in anomaly in the payload are given on the « bad vibration » period : operating time-[0-10%] time To have the value in percentage: [value in minutes]/[Report period]*100	
13	[20%-40%] anomaly level time	2a	42	$(180-128)*42/127=17$	min	Raw data of time in anomaly in the payload are given on the « bad vibration » period : operating time-[20-40%] time To have the value in percentage: [value in minutes]/[Report period]*100	
14	[40%-60%] anomaly level time	00	0	$(180-128)*0/127=0$	min	Raw data of time in anomaly in the payload are given on the « bad vibration » period : operating time-[40-60%] time To have the value in percentage: [value in minutes]/[Report period]*100	
15	[60%-80%] anomaly level time	00	0	$(180-128)*0/127=0$	min	Raw data of time in anomaly in the payload are given on the « bad vibration » period : operating time-[60-80%] time To have the value in percentage: [value in minutes]/[Report period]*100	
16	[80%-100%] anomaly level time	00	0	$(180-128)*0/127=0$	min	Raw data of time in anomaly in the payload are given on the « bad vibration » period : operating time-[80-100%] time To have the value in percentage: [value in minutes]/[Report period]*100	
17	Battery percentage	7c	124	$124 \times 100 / 127 = 97,6$	%	Estimated, based on current consumption and time spent in each mode (data acquisition, IA processing, Lora transmission, sleep mode)	
18-26	Anomaly forecasts 24h:20%-50%-80% 30d:20%-50%-80% 6m:20%-50%-80%	77 ff ff ff ff ff ff ff ff	119 255 255 255 255 255 255 255255	119/ / / / / / / / /	hours days months	Forecasts are calculated with a linear regression, using data of the previous 24h, respectively 30 days, and 6 months. If value = 255, it means infinite time, we suggest not to display any value	

3.4. ALARM MESSAGE

3.4.1. Payload structure

Byte	Definition	Value (dec)	Real_Value (dec)	Unit	Range	Type	Description
0	Header	MPU=65 Or KX=97		const		N/A	Sensor type : MPU = "A" (hex=0x41) => Alarm header or KX = "a" (hex=0x61) => alarm header
1	Anomaly level	0~127	Value*100/127%		[0,100]	float	Anomaly level recorded for the alarm
2	Temperature	0~127	Value-30	°C	[-30,97]	integer	Temperature measured for the sample, which triggered the alarm event (default anomaly level for the alarm trigger is 25%, can be changed through a Downlink command, see corresponding chapter)
3	NA	NA	NA		NA		Reserved for future use
4	Vibration level (vl_1)	0~127	Value				Vibration level measured for the sample, which triggered the alarm event $vl=(vl_1*128+vl_2+vl_3/100)/10/121.45$
5	Vibration level (vl_2)	0~127	Value	g	[0,127]	float	
6	Vibration level (vl_3)	0~127	Value				
7	NA	NA	NA	NA	NA		NA
8~39	FFT signal (needed to be calculated with vibration level)	0~127		g; Hz			FFT signal measured for the sample, which triggered the alarm event Value_g=Value*vl/127; (see bytes 2-3-4 for vl value calculation) MPU (peak frequency step = 7.81Hz): Frequency_hz=4*(i+1)*FREQ_SAMPLING_ACC_HF/256 (i is the index of FFT array, begins from 0, ends by 31) KX (peak frequency step =6.25Hz): Frequency_hz=(i+1)*FREQ_SAMPLING_ACC_HF/256 (i is the index of FFT array, begins from 0, ends by 31)

3.5. STATE MESSAGE payload structure

(STATE message is the first applicative payload sent by the device after power-on)

Byte	Definition	Value (dec)	Real_Value (dec)	Unit	Range	Type	Comments
0	Header	MPU/KX = 83				N/A	Sensor type : MPU /KX = "S" (hex=0x53) => State header (same value for any type of Inertial Motion Unit)
1	sensor & machine states	100~101;125~126	(Value)			N/A	100: Sensor start; 101: Sensor stop; 125: Machine stop; 126: Machine start
2	Battery percentage	0~127	Value*100/127	%	[0,100]	integer	Remaining battery level

IV. Downlink (LoRa to device)

Note : Downlink commands have to be sent one by one.

4.1. Renew learning mode or add learning

Definition	Byte to send (hex)	Downlink Port
Restart learning from 0	0x50	1
Additional Learning	0x51	1

Restart learning will erase the previous vibration points map and learn up to 50 new vibration signatures
Additional Learning will learn new vibration signatures (adding the new vibration signatures to the one previously recorded, up to 50 in total)

4.2. Change sampling period

Definition	Learning period	Monitoring period	Downlink value (hex)	Downlink Port
Very Fast Mode	10 sec	20 sec	0x52	1
Fast Mode	20 sec	2 min	0x53	1
Default Mode	60 sec	5 min	0x54	1
Slow Mode	2 min	10 min	0x55	1

4.3. Enable/disable STATE MESSAGE

Definition	Downlink value (hex)	Downlink Port
Enable State Message	0x56	1
Disable State Message	0x57	1

The Downlink message “Enable State Message” activates the start/stop machine notification (default configuration)

The Downlink message “Disable State Message” deactivates the start/stop machine notification (used mostly to spare sensor energy in case of frequent state transitions)

Note:

2 years warranty is guaranteed for nominal operation which implies:

- **5 min period measurement**
- **8 start/stop messages per day**

Note: Start/stop messages and battery life

We recommend to automatically disable start/stop messages if the total number of message received during the first month of operation is more than 500.

4.4. Change ALARM MESSAGE threshold

Definition	Downlink value (hex)	Downlink Port
Alarm Threshold when anomaly > 10%	0x58	1
Alarm Threshold when anomaly > 15%	0x59	1
Alarm Threshold when anomaly > 20%	0x5A	1
Alarm Threshold when anomaly > 25%	0x5B	1

V. Charts examples

5.1. Breakdown of the operating time of the machine

Time of operation, expressed in minutes, over a 3 hours period of analysis.

- Operating time**

 - Operating Rate
 - Breakdown of the operating time of the machine
- Health**

 - Anomaly distribution
 - Avg unnatural vibration level in reports
 - Number of drift notifications
- Other data**

 - Temperature
 - Max value
 - Peak frequency
 - RSSI

Breakdown of the operating time of the machine

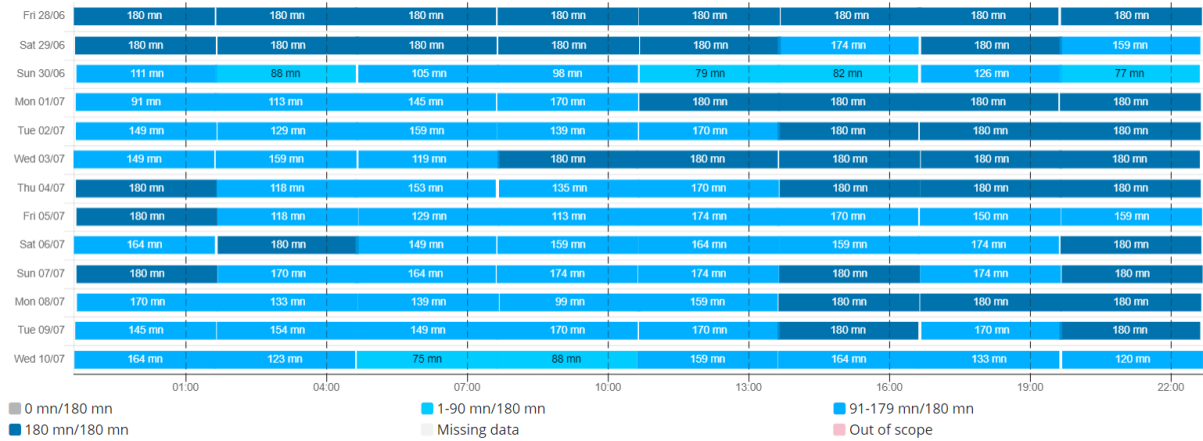

5.2. Anomaly distribution

Displays the level of abnormal vibration, related to a percentage of time spent in each zone, from very good (green) to very bad (red). Each bar shows a 3hour period of time. Gray zone exhibits the time the machine is off

- Operating time**

 - Operating Rate
 - Breakdown of the operating time of the machine
- Health**

 - Anomaly distribution
 - Avg unnatural vibration level in reports
 - Number of drift notifications
- Other data**

 - Temperature
 - Max value
 - Peak frequency
 - RSSI

Anomaly distribution

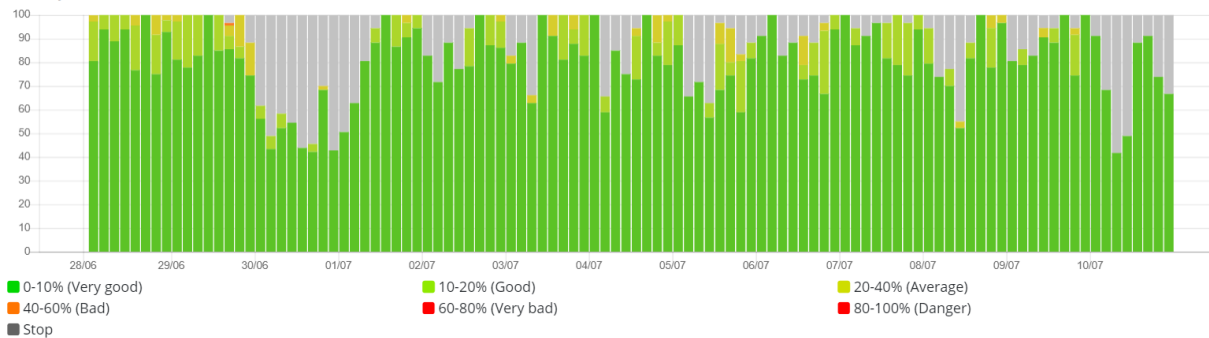

5.3. Average unnatural vibration level in reports

Vibration drift ratio average value, calculated over a 3 hours period, and compared to the reference vibration signature(s). Custom notifications can be set on this value

- Operating time**
 - Operating Rate
 - Breakdown of the operating time of the machine
- Health**
 - Anomaly distribution
 - Avg unnatural vibration level in reports
 - Number of drift notifications
- Other data**
 - Temperature
 - Max value
 - Peak frequency
 - RSSI

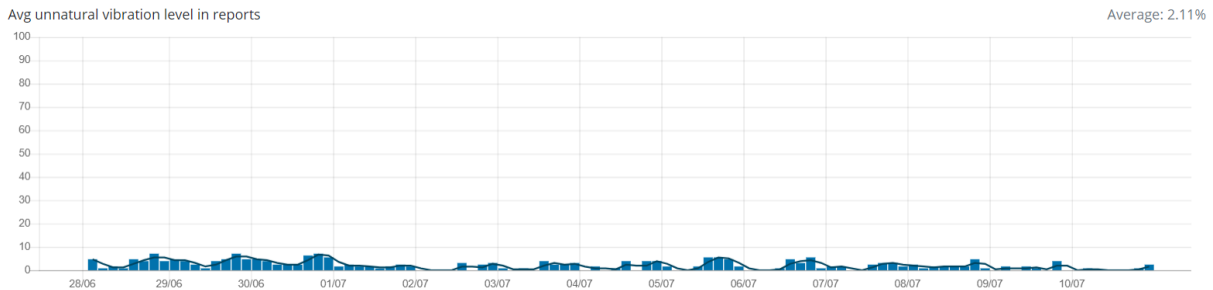

5.4. Number of drift notifications

Number of alarms that BoB has sent, when anomaly level exceeds 25%

- Operating time**
 - Operating Rate
 - Breakdown of the operating time of the machine
- Health**
 - Anomaly distribution
 - Avg unnatural vibration level in reports
 - Number of drift notifications
- Other data**
 - Temperature
 - Max value
 - Peak frequency
 - RSSI

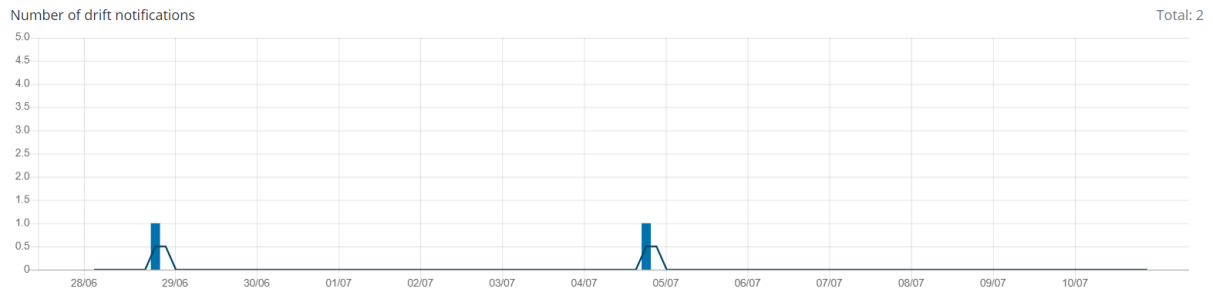

5.5. Temperature

Average temperature reported every 3h. Please note that this temperature is not the surface temperature of your machine, but an ambient average value measured inside the sensor casing.

- Operating time**
 - Operating Rate
 - Breakdown of the operating time of the machine
- Health**
 - Anomaly distribution
 - Avg unnatural vibration level in reports
 - Number of drift notifications
- Other data**
 - Temperature
 - Max value
 - Peak frequency
 - RSSI

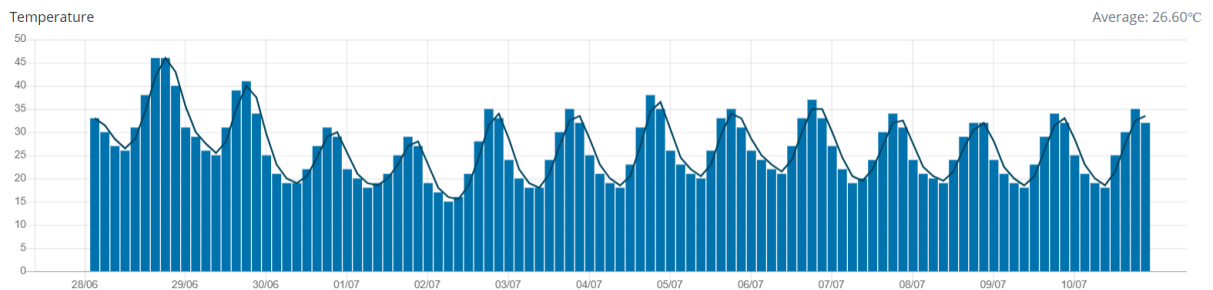

5.6. Maximum vibration value

Maximum vibration amplitude in [g].

Operating time

- Operating Rate
- Breakdown of the operating time of the machine

Health

- Anomaly distribution
- Avg unnatural vibration level in reports
- Number of drift notifications

Other data

- Temperature
- Max value
- Peak frequency
- RSSI

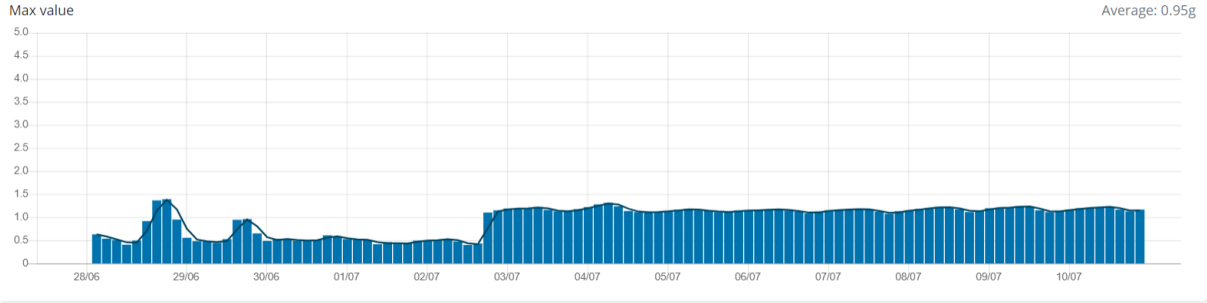

5.7. Peak Frequency

Frequency related to the maximal amplitude reported

Operating time

- Operating Rate
- Breakdown of the operating time of the machine

Health

- Anomaly distribution
- Avg unnatural vibration level in reports
- Number of drift notifications

Other data

- Temperature
- Max value
- Peak frequency
- RSSI

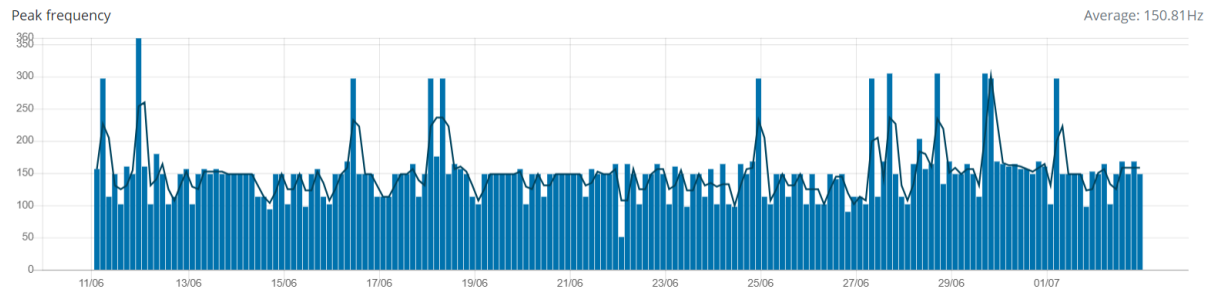

5.8. Report view

Report
×

Machine	-
BOB's ID	-
BOB's name	BOB7754
Description de BOB	-
Rapport envoyé	2019/07/23 08:27:53
Operating Time	180 min
Operating Rate	<div style="width: 100%; height: 10px; background-color: #007bff; position: relative;"> 100 % </div>
Time in Anomaly ■ Stop ■ 0-10% (Very good) ■ 10-20% (Good) ■ 20-40% (Average) ■ 40-60% (Bad) ■ 60-80% (Very bad) ■ 80-100% (Danger)	<ul style="list-style-type: none"> ■ Very good: 26.67% ■ Good: 39.44% ■ Average: 33.89%
Unnatural vibration level	<div style="width: 16.5%; height: 10px; background-color: #28a745; position: relative;"> 16.5 % </div>
Number of drift notifications	0
Peak Frequency	207.03125 Hz
Max vibration amplitude	0.0575 g
Temperature	32 °C
RSSI	-42 dBm
Report length	180 min
Battery percentage	<div style="width: 76%; height: 10px; background-color: #007bff; position: relative;"> 76 % </div> Remaining: - 3 years

Anomaly prediction / Observed period	Last 24 hours	Last 30 days	Last 6 months
Anomaly 20 %	0 hours	infini	infini
Anomaly 50 %	194 hours	infini	infini
Anomaly 80 %	infini	infini	infini

5.9. Vibration drift Alarm view

! Alarm
×

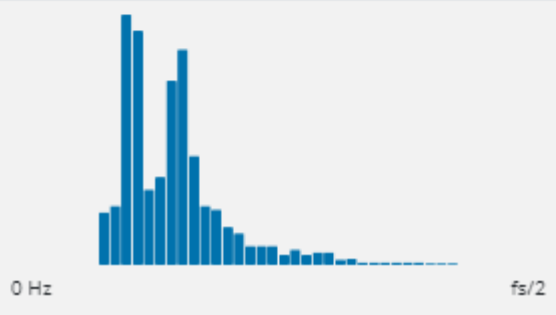
Machine	Demo fleet
BOB's ID	70b3d531c0001189
BOB's name	BOB7754
Description de BOB	-
Rapport envoyé	2019/06/05 16:22:35
Unnatural vibration level	<div style="display: flex; align-items: center;"> <div style="width: 64.6%; height: 10px; background-color: red; margin-right: 5px;"></div> 64.6 % </div>
Peak Frequency	39 Hz
Max vibration amplitude	0.0639 g
Temperature	31 °C
RSSI	-21 dBm
Signature vibratoire	 <p style="font-size: small; margin-top: 5px;">0 Hz fs/2</p>

VI. Payload examples

6.1. Raw payload

6.1.1. Payload samples for MPU version (BoB v1.0 / PN:3.x)

Type	Payload cleartext (hex)	frame number	Comment
UPLINK	417f3800010c2e156551377f3b7d63425a4e231b1711101a100c0b0a0a07070506050605050506	10	Anomaly
UPLINK	52017f7f003802000108460c0000000007ffffffffffffffff	9	Report
UPLINK	537e7f	8	machine on
UPLINK	537d7f	7	machine off
UPLINK	4c640109140c38010303087f07041303010201010101010101010101010100000000010000000000	6	Learning complete
UPLINK	4c500108090c38010304097f070414020203010101010101010101010101010101000100000000000000	5	Learning 80%
UPLINK	4c3c0109580c38010303087f0703130302030101010101010101010101010101010000000000000000	4	Learning 60%
UPLINK	4c28010a5a0c38010303087f0703130202030101010101010101010101010101010100010000000000	3	Learning 40%
UPLINK	4c14010b3e0c38010203097f07031302020302010101010101010101010100010100000000000000	2	Learning 20%
UPLINK	4c00010e2e0c38010204097f0503110202030101010101010101010101010101010100000000000000	1	Learning process start
UPLINK	53647f		Sensor start
JOIN			

6.1.2. Payload samples for KX version (BoB v1.1 / PN:4.x)

Type	Payload cleartext (hex)	frame number	Comment
UPLINK	6137320003105C0E201F45462A171F18483E454C285D7F37241610181C10180D0E0E070C110C0A0C	10	Anomaly
UPLINK	72097f5f00313e0700284c537f000000007cffffffffffffffff	9	Report
UPLINK	537e7d	8	machine on
UPLINK	537d7d	7	machine off
UPLINK	6c64002d190133014c7f4731542f383531263326292c403046433d472c181e252e34232c38202531	6	Learning complete
UPLINK	6c5000333f013301407f3d25572f3228333b251c231b2e3831492d26241812181f1d182d2029383a	5	Learning 80%
UPLINK	6c3c00384b013301347f4f2a512830343a2221152d1c273242492d331e171618262413221b2d3841	4	Learning 60%
UPLINK	6c2800394e013301417f432b4f2f36232d23261c242731233a452d341714171a261f1c2324333738	3	Learning 40%
UPLINK	6c140031150134013c7f3c284b2a393f29321f1e223248294754492b191616202720212a2d28383b	2	Learning 20%
UPLINK	6c00001f3f013601407f5b4467393c303176301c332b61345b7e303e2318373f333f2231444a4245	1	Learning process start
UPLINK	53647f		Sensor start
JOIN			

6.2. KX version Decode examples

6.2.1. LEARNING TYPE

Payload: [6c6401015c0a3b0104067f0b060f6706051f130f4117071407071428081325070403030202020202]

```
{
  "type": "learning",
  "sensor": "KX",
  "msg": {
    "temperature": 29,
    "learningfromscratch": 1,
    "learningpercentage": 100,
    "vibrationlevel": 0.107,
    "peakfrequencyindex": 11,
    "peakfrequency": 34.38,

    "fft": [
      0.0034,
      0.0051,
      0.107,
      0.0093,
      0.0051,
      0.0126,
      0.0868,
      0.0051,
      0.0042,
      0.0261,
      0.016,
      0.0126,
      0.0548,
      0.0194,
      0.0059,
      0.0168,
      0.0059,
      0.0059,
      0.0168,
      0.0337,
      0.0067,
      0.016,
      0.0312,
      0.0059,
      0.0034,
      0.0025,
      0.0025,
      0.0017,
      0.0017,
      0.0017,
      0.0017
    ]
  }
}
```

6.2.2. REPORT TYPE

Payload: [720D7F27013B0206001B011A7F000000007FFFFFFFFFFFFFFFFFFFFF]

```
{
  "type": "report",
  "sensor": "KX",
  "msg": {
    "batterypercentage": 100,
    "anomalylevel": 10.2,
    "anomalylevelto20last6mo": 255,
    "nbalarmreport": 1,
    "operatingtime": 2,
    "totalunknown6080": 0,
    "totalunknown4060": 0,
    "totalunknown2040": 0,
    "anomalylevelto80last30d": 255,
    "vibrationlevel": 0.0222,
    "totalunknown1020": 1,
    "anomalylevelto80last6mo": 255,
    "anomalylevelto50last24h": 255,
    "anomalylevelto20last24h": 255,
    "anomalylevelto50last30d": 255,
    "temperature": 29,
    "reportlength": 2,
    "anomalylevelto20last30d": 255,
    "peakfrequencyindex": 27,
    "totalunknown80100": 0,
    "totaloperatingtimeknown": 1,
    "anomalylevelto50last6mo": 255,
    "anomalylevelto80last24h": 255
  }
}
```

6.2.3. ALARM TYPE

Payload: [611C3B010044351C7F121D1D101D2F302B291E15110C090908080707060504030303020201020102]

```
{
  "type": "alarm",
  "sensor": "KX",
  "msg": {
    "temperature": 29,
    "vibrationlevel": 0.0564,
    "anomalylevel": 22,
    "fft": [
      0.0564,
      0.008,
      0.0129,
      0.0129,
      0.0071,
      0.0129,
      0.0209,
      0.0213,
      0.0191,
      0.0182,
      0.0133,
      0.0093,
      0.0076,
      0.0053,
      0.004,
      0.004,
      0.0036,
      0.0036,
      0.0031,
      0.0031,
      0.0027,
      0.0022,
      0.0018,
      0.0013,
      0.0013,
      0.0013,
      0.0009,
      0.0009,
      0.0009,
      0.0004,
      0.0009,
      0.0004,
      0.0009
    ]
  }
}
```

6.2.4. STATE TYPE

Payload: [53647F]

```
{  
  "type": "state",  
  "sensor": "KX",  
  "msg": {  
    "state": 0,  
    "batterypercentage": 100  
  }  
}
```

VII. Frequently Asked questions

7.1. Why monitor vibrations and their drift?

When the state of a rotating machine changes, vibration drift is the first measurable symptom:

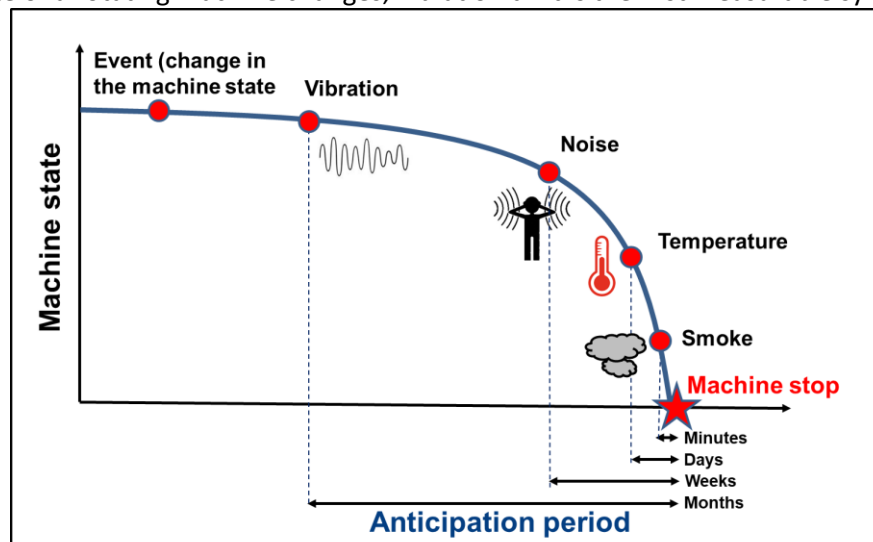

However, a distinction must be made between breakdowns due to wear or tear (slow drift) and breakage (fast drift). The increase in the level of the anomaly can therefore sometimes occur only a few days before the failure. The maintenance team will always be the most able to analyse and intervene on the equipment when BoB ASSISTANT reports an anomaly.

7.2. What are the main causes of vibration anomaly?

Possible cause	Corresponding frequency
Off balance	Rotation frequency
Misalignment	2 x rotation frequency
Bearing fault	3 to 10 x rotation frequency [2kHz - 60kHz]
Instability	Natural frequency of the equipment
Belt fault	Rotation frequency + harmonics
Fan fault	Number of blades x natural frequency
Electrical fault	Line frequency (50Hz) + harmonics
Gear	Natural frequency x number of gears
Natural frequency resonance	Natural frequency

7.3. Which type of equipment is well suited for BoB ASSISTANT?

BoB ASSISTANT measures the vibrations of a machine and analyses its evolution over time. Vibration signature deviations are detected in real time and an alert is sent if the deviation exceeds a 25% threshold. In addition, the projections predict the level of anomaly in the coming weeks/months.

Also, BoB ASSISTANT will work very well on equipment with one or several stationary vibration regimes



Air Compressor



Motor



Air conditioning group



Oven



Pump



Suction turbine



Central air treatment



Stove

On the other hand, equipment in motion or exhibiting random or time-varying vibration regimes will not be eligible for the BoB ASSISTANT offer:



Rolling/Moving stocks



Automated arms

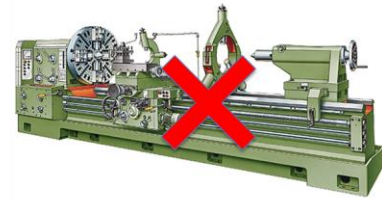

Machine-tool / short cycles

7.4. What is the temperature limit?

The surface temperature of your equipment must not exceed 55°C.

7.5. When should BoB ASSISTANT be installed on the equipment?

BoB ASSISTANT performs a vibration signature training during the first 7 days after it is turned ON. During this period, it is crucial that the vibration signature is as close as possible to normal/representative machine operation. It is therefore strongly recommended to start BoB ASSISTANT on new equipment or most commonly, shortly after a maintenance operation.

7.6. Can we start BoB ASSISTANT on a machine that is not running?

If your machine is stopped during installation, you can still position BoB ASSISTANT and start it. The learning procedure will start when the equipment is back on. You must still make sure that the vibration is sufficient at this position. In case of doubt, it is preferable to install BoB ASSISTANT on a machine in operation.

7.7. Can BoB ASSISTANT or the machine be moved without disrupting its operation?

No. The learning of the vibration signature is closely linked to the positioning of the sensor on the machine, its orientation and its environment. Changing these conditions requires a relearning which can be done by turning the product OFF and then back ON.

The addition of a vibrating machine near the monitored equipment can also disrupt the operation of BoB ASSISTANT and cause additional alerts.

7.8. What is the autonomy of BoB ASSISTANT sensors?

In its standard use, BoB ASSISTANT's autonomy is a minimum of 2 years.

The autonomy of Bob is estimated by counting the number of messages sent, in addition to embedded calculus. It is therefore not nominal because, depending on its use, a greater or lesser number of alerts may be sent.

If your machine has many stop and start cycles during the course of a day, the start/stop messages will be numerous and will have a strong impact on BoB ASSISTANT's autonomy. Beyond 8 start/stop per day, it is recommended to disable these messages. The time and operating rate will always be available in the reports sent every 3 hours.

In its normal operation, BoB ASSISTANT's autonomy is a minimum of 2 years.

7.9. How to evaluate LorA coverage? What is the operating limit?

Depending on the environment of the sensor, it is sometimes hard to define if a Public Network will cover BoB location. The best way to know the strength of the real signal is to measure it with a dedicated sensor ([example here](#))



RSSI : Strength of the radio signal sent by Bob at the Gateway level (risk of message loss/missing data)

7.10. First learning and complete learning, what is the difference?

As BoB ASSISTANT starts, it initiates a first learning phase. This phase can be more or less long depending on the type of equipment, the complexity of its vibration signature and the number of operating speeds. It can last between 1 hour for the simplest systems and a few days for complex equipment.

You can track the progress of the learning on your dashboard, with a report sent every 20%.

After the first learning session, BoB ASSISTANT starts sending machine status data. A report is sent every 3 hours. However, BoB ASSISTANT stays tuned for 7 days and continues to learn. It analyses the new perceived vibrations, compares them to those already learned, and records them if they are relevant. It is therefore normal to see the level of abnormality gradually reduce during the first week. There will be no alerts sent during this 7 days.

After 7 days, BoB ASSISTANT has completed its training and is watching over your machine.

7.11. Bob started his learning but does not complete it. Why?

- **Discontinuous operation:** The machine operates very discontinuously and the learning process is paused when it is stopped. It resumes when the machine is restarted, but the complete learning session will take longer. If the 20% progress is not reached after 24 hours, see the following explanation.

- **Unsufficient vibration:** BoB ASSISTANT does not pick up enough vibration. Typically, **if the vibration intensity is below 0.01g, BoB ASSISTANT will not be able to learn correctly.** The vibration amplitude information is given by the learning report (see §3.2 *LEARNING MESSAGE*) . In this case, we recommend moving the sensor closer to the machine's vibration source (motor, compressor, etc.)

7.12. Why one BoB ASSISTANT is taking more time to complete its learning than another one?

The complete learning mode lasts 7 days. The first learning session lasts between 1 hour and a few days depending on the complexity of the vibration signature (number of vibration sources...).

An intermittent device, for example, will take longer to analyze because the learning is stopped if the machine is switched off. It will resume when the machine restarts.

7.13. Why is BoB ASSISTANT learning several time in the first week of operation?

After his first learning session, BoB ASSISTANT improves and continues to analyze the vibratory phenomena of the machine for 7 days. You are informed of a new learning phase by a Learning message. It is also normal for BoB ASSISTANT to refine its reports on the behaviour of your machine during the first week.

BoB ASSISTANT can learn up to 20 different vibration regimes.

At the end of the 7 days, the analysis is stabilized and BoB ASSISTANT only alerts you when actual drifts are observed.

7.14. How to make an additional learning or start BoB ASSISTANT over?

To reset BoB ASSISTANT, simply press and hold (10 seconds) the device button. By restarting BoB ASSISTANT, it then restarts its learning mode as it did when it was first powered up.

To trigger a complete relearning, or a complementary learning, use the Downlink commands described in § 4.1 *Renew learning mode or add learning*

7.15. Some data are missing?

The main reason for data loss is a bad/low LoRa network coverage. You can check the signal strength using the RSSI indicator provided by your LoRa Network Server:

- from 0 to -90dBm: good coverage, no risk of data loss
- from -90dB to -110dBm: medium coverage, low risk of data loss
- -110dBm and lower: low coverage, proven risk of data loss

The metallic environment can also cause message loss (Faraday cage effect)

7.16. Missing data and operating time

If LoRa network coverage is low, Report messages may exceptionally not be received and will not appear in your stream. Frames not received should be excluded from the operating rate: the corresponding 3 hours should not be taken into account.

On the other hand, if you notice many missing Report messages, we recommend adding a LoRa gateway to improve LoRa network performance.

7.17. BoB ASSISTANT did not detect any anomalies, however, a failure occurred. What to do about it?

Check that BoB ASSISTANT has been positioned as close as possible to the vibration source. If your machine has several sources of vibration, it may be interesting to place several BoB ASSISTANTS on the equipment, especially on complex and bulky machines.

A wear or breakdown are almost always preceded or accompanied by a change in the vibration signature.

7.18. What is the difference between alarm and notification?

An alarm is sent by BoB ASSISTANT when it detects an anomaly greater than 25%. This generic value was determined after hundreds of thousands of hours of experimentation with the solution and corresponds to the most common case: when the anomaly level reaches 25%, you should check your equipment.

However, each piece of equipment has its own vibration regime and notifications allow you to customize the alert thresholds according to your expectations and the criticality of your requirements. For more information on custom notifications, see the following paragraph.

7.19. How to configure a notification trigger threshold?

At the end of the learning mode the average abnormal vibration level is generally low (<10%). It is advisable to wait 3 weeks to observe this average level, and to establish a notification threshold accordingly.

It is therefore recommended that the platform manages a notification system based on the average unnatural vibration level in reports.

Example :

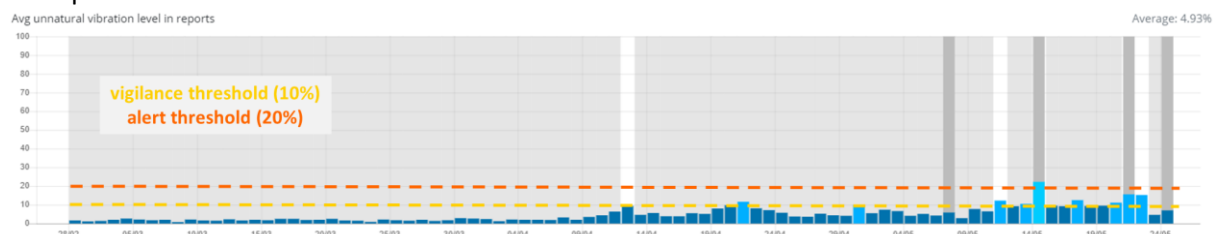

In this case, the average abnormal vibration level is 5%. The variations observed may correspond to the different phases of the machine (start-up, variations related to climatic conditions). A relevant alert threshold for notifications on abnormal vibration level is 10%. In case of an alert, this does not mean that your machine is in immediate danger but that vigilance is required.

You can also set up several notifications:

- 10% vigilance threshold
- 20% alert threshold (recommended physical intervention)

As a general rule, if a large number of notifications are received shortly after installation, the trigger threshold is probably too low and should be raised.

7.20. Why does the learning progress report indicate a value outside of expected values (20%, 40%...)?

If the machine is stopped during the learning process, BoB ASSISTANT detects it and pauses the learning. It will resume when the machine restarts.

However, if the machine stop exceeds a certain time, an activity report is sent (every 3 hours), indicating the progress, which can be blocked between 2 standard values.

7.21. Is it possible to check the activity and proper functioning of BoB ASSISTANT on request?

No. In its nominal operation, BoB ASSISTANT sends a report every 3 hours, and real-time alerts in case of unexpected events (vibration alarm, machine off...)

7.22. What is the range of BoB ASSISTANT (communication distance) in an industrial environment?

The LoRa modulation is dedicated to the transmission of short messages, at low transmission frequencies and over long distances. In free space (no obstacles) this range can reach several kilometers (up to 14km).

On the other hand, in an industrial environment, various metal equipment and structures are obstacles that create electromagnetic interference and reflections that can reduce BoB ASSISTANT's radio performance and range to a few hundred meters.

When a gateway is installed, the range in an industrial environment can go down between 50m to 500m

7.23. Are the transmitted data secure?

The data is encrypted using 2 layers of AES-128 encryption. This encryption is natively supported by the LoRaWAN protocol, as the payload is encrypted using a first key (AppSKey = Application Session Key) and the LoRaWAN header plus the encrypted payload are encrypted using a second key (NwksKey = Network Session Key).

The session keys are derived from a symmetric private key during the join session.

7.24. I started BoB ASSISTANT, but no message arrives on the livestream

Check that the network coverage is sufficient, and refer to the user manual to learn more about the LED sequences displayed by the sensor during startup.

7.25. How do I position BoB ASSISTANT on my machine?

It is recommended to position BoB ASSISTANT on a flat and clean surface, as close as possible to the vibration source:

- On "simple" equipment (motor, pump, compressor): place BoB ASSISTANT directly on the equipment.
- On "complex" equipment: place BoB ASSISTANT on the chassis.

You can put your hand on the surface to feel the vibration. **FIRST MAKE SURE THAT THE SURFACE TEMPERATURE OF THE EQUIPMENT DOES NOT PRESENT A DANGER**

VIII. Document history

V1 - 2020/06/18: Document renamed as Reference Manual, product variants table update and frequency monitoring clarification, update of the frequency calculation of the FFT for Learning and Alarm messages, adding details on product fastening solutions, product functional overview, and FAQ section

V1.1 - 2020/10/23: Updated §3.3.1 *Payload structure* table rows:

- From 2 to 3 :
update “*Range*” ([0,100] to [0, report_period]) and “*Unit*” (% to Minute) values
- From 12 to 16:
update “*Range*” value ([0,100] to [0, report_period]) ;
update “*Real_Value (dec)*” from ([0%-10%] anomaly level time)*Value/127 to (**Operating time** - [0%-10%] anomaly level time)*Value/127

--- end of document ---